



MUSICAL INSTRUMENTS CATALOGUE



DEFINE YOUR TONE

Palmer stands for 35 years of experience in analog audio technology.

Our tools have proved themselves to be dependable and practically invaluable helpers for musicians and technicians alike.

The Musical instruments category mainly focuses on tools for musicians, in particular for guitarists and bass players. We are proud to present our new catalogue, featuring tried and true pieces of equipment along with several new devices.

www.palmer-germany.com

Palmer® is a brand of the Adam Hall Group.



www.facebook.com/palmergermany
www.youtube.com/palmergermany
blog.adamhall.com

The information and numerical data contained in this publication has been prepared as a general guide to the products, potential buyers and users must however satisfy themselves as to the suitability and the applicability of the products for their particular purposes and duties. No responsibility is assumed for any errors herein. The company reserves the right to alter the designs, materials and specifications of the products shown in this publication without notice.

TABLE OF CONTENTS

EFFECTS PEDALS	06 - 15
PEDALBOARDS	16 - 19
POWER SUPPLIES	20 - 25
PREAMPS	26 - 29
SWITCHERS	30 - 37
SPEAKER SIMULATORS	38 - 43
POWER SOAKS & LOAD BOXES	44 - 45
SPLITTERS & MERGERS	46 - 49
GUITAR AMPLIFIERS	50 - 55
GUITAR CABINETS	56 - 63

OFFICIAL PALMER ARTISTS

GOOD ENOUGH FOR THEM, GOOD ENOUGH FOR YOU!



THE BLACK KEYS



GARY CLARK JR.



DEF LEPPARD



THE BLACK DAHLIA MURDER



JOE BONAMASSA



APOCALYPTICA



ASKING ALEXANDRIA



DEFTONES



FALL OUT BOY



MASTODON

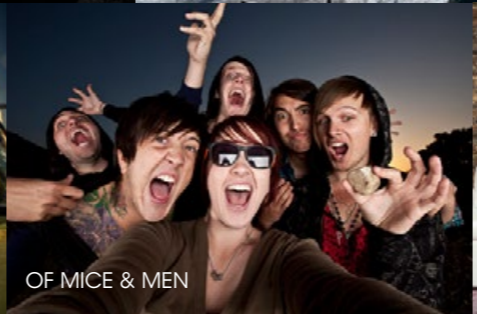

OF MICE & MEN



VOLBEAT

ALSO:
ANDRE TONELLI, JUSTIN MELDAL-JOHNSEN, NEW POLITICS, KVELERTAK, DEREK SHERINIAN,
CELKILT, 4LYN, SUBWAY TO SALLY AND MANY MORE...

FIND OUT MORE ON
WWW.PALMER-GERMANY.COM

ROOT EFFECTS

EFFECT PEDALS

EFFECTS
PEDALS

FIND YOUR ROOTS!

With the root series Palmer offers a variety of rugged high quality effect pedals ranging from warm authentic distortion to a gentle, yet highly efficient compressor. Delivering bang for the buck, root pedals provide a solid effects base for professional guitar players and beginners alike. They have their own distinctive characteristics and the renowned quality standard of all Palmer products.

- Heavy duty 2mm steel housing - built to last.
- Pedals can be securely screwed to your pedalboard thanks to mounting holes in the overhang of the housing base plate.
- "True bypass"
- Powered by an optional 9V DC supply (PW9V or PWT12) or PP3 battery.
- Quick access battery compartment located at the bottom of the pedals.



OPTIONAL 9VDC POWER SUPPLY
(ART. NO.: PW9V) AVAILABLE

SOLID METAL

The PESH Solid Metal is a hard distortion pedal with controls for distortion, output volume, and a 3-band EQ. The semi parametric midrange provides a wide variety of sounds from classic rock to extreme metal.

SPECIFICATIONS

Input impedance:	1 M Ω
Output impedance:	100 K Ω
Controls:	HI, MID, MID FREQ, LOW, DIST, VOL, FOOTSWITCH
Indicator:	LED
Connectors:	IN, OUT, DC input (9 V)
Power requirements:	9 V PP3 or 9 V DC supply (optional)
Power consumption:	18 mA (9 V DC)
Dimensions (W x H x D):	120 x 60 x 140 mm



OVERDRIVE

The PEOD Overdrive is designed to saturate both your guitar signal and amplifier. The Clean control mixes your original guitar signal in with the overdriven signal to maintain attack and definition providing the effect of stacked amps, one set clean and the other with a distorted setting. The pedal can also be used as a booster with the clean control all the way up and the gain control at 0. With the clean control at 0, the PEOD provides all the sounds of a classic overdrive effect.

SPECIFICATIONS

Input impedance:	1 M Ω
Output impedance:	100 K Ω
Controls:	GAIN, CLEAN, TONE, LEVEL, FOOTSWITCH
Indicator:	LED
Connectors:	IN, OUT, DC input (9 V)
Power requirements:	9 V PP3 or 9 V DC supply (optional)
Power consumption:	12 mA (9 V DC)
Dimensions (W x H x D):	120 x 60 x 120 mm





HURRIGAIN

The PEHUR Hurrigain pedal combines fuzz and overdrive effects. Reminiscent of the classic 60ies and 70ies sounds. The Hurrigain is also capable of generating extremely mean and aggressive fuzz tones - this pedal is BAD!

SPECIFICATIONS

Input impedance:	1 M Ω
Output impedance:	100 K Ω
Controls:	VOLUME, TONE, FUZZ, FOOTSWITCH
Indicator:	LED
Connectors:	IN, OUT, DC input (9 V)
Power requirements:	9 V PP3 or 9 V DC supply (optional)
Power consumption:	12 mA (9 V DC)
Dimensions (W x H x D):	120 x 60 x 120 mm



DISTORTION

The PEDIS is a classic distortion pedal with a twist suitable for all musical styles. Simplistic, yet extremely versatile the Filter control provides a wide variety of interesting sounds with complex phase response unobtainable with standard bass and treble controls.

SPECIFICATIONS

Input impedance:	1 M Ω
Output impedance:	100 K Ω
Controls:	FILTER, VOLUME, DISTORTION, FOOTSWITCH
Indicator:	LED
Connectors:	IN, OUT, DC input (9 V)
Power requirements:	9 V PP3 or 9 V DC supply (optional)
Power consumption:	20 mA (9 V DC)
Dimensions (W x H x D):	120 x 60 x 120 mm



COMPRESSOR

The PECOMP Compressor controls the dynamics of your guitar signal for increased punch and sustain. The PECOMP features a low-noise circuit that is absolutely free from distortion.

SPECIFICATIONS

Input impedance:	1 M Ω
Output impedance:	100 K Ω
Controls:	LEVEL, ATTACK, SUSTAIN, FOOTSWITCH
Indicator:	LED
Connectors:	IN, OUT, DC input (9 V)
Power requirements:	9 V PP3 or 9 V DC supply (optional)
Power consumption:	12 mA (9 V DC)
Dimensions (W x H x D):	120 x 60 x 120 mm



CHORUS

The Chorus-Pedal (PECHOR) is a classic smooth Chorus effect. A chorus effect works on the basis of small constantly varying delays (4-8 milliseconds) - this leads to the impression that more than one instrument is playing.

SPECIFICATIONS

Input impedance:	500 K Ω
Output impedance:	100 K Ω
Controls:	SPEED, DELAY TIME, DEPTH, FOOTSWITCH
Indicator:	LED
Connectors:	IN, STEREO OUT, DC input (9V)
Power requirements:	9 V PP3 or 9 V DC supply (optional)
Power consumption:	20 mA (9 V DC)
Dimensions (W x H x D):	120 x 60 x 120 mm



PHASER

This pedal provides a wide range of effects similar to a rotating loudspeaker and powerful jet engine sounds with a rich multi-dimensional feel.

SPECIFICATIONS

Input impedance:	1 M Ω
Output impedance:	100 K Ω
Controls:	RATE, RESONANCE, DEPTH, FOOTSWITCH
Indicator:	LED
Connectors:	IN, OUT, DC adaptor jack
Power requirements:	9V DC adaptor (not included)
Power consumption:	12 mA (9 V DC)
Dimensions (W x H x D):	120 x 56 x 95 mm



FLANGER

This pedal provides smooth state-of-the-art flanging that is rich in depth. Separate Rate, Depth and Mix allow for a wide range of settings.

SPECIFICATIONS

Input impedance:	1 M Ω
Output impedance:	100 K Ω
Controls:	RATE, DEPTH, MIX, FOOTSWITCH
Indicator:	LED
Connectors:	IN, OUT, DC adaptor jack
Power requirements:	9V DC adaptor (not included)
Power consumption:	16 mA (9 V DC)
Dimensions (W x H x D):	120 x 56 x 95 mm

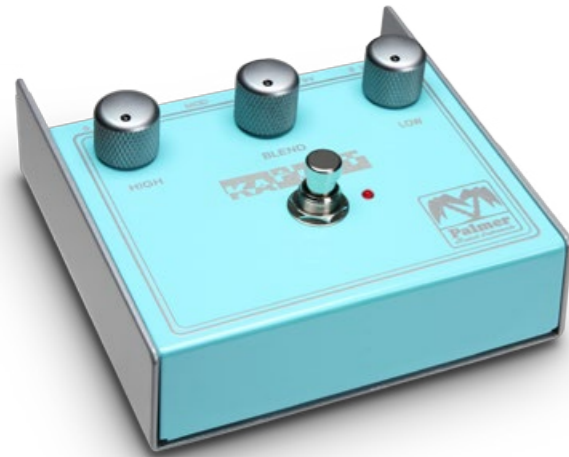

KAPUTT

The Palmer Kaputt actually creates an octave effect. Actually... Several additional features work to produce cool, interesting and even "distorted" sounds — especially appealing for intros, outros etc. In certain settings, the octave effect develops a certain life of its own — just a little more drag from the HIGH controller, mix in a few overtones and there you have your distorted sound!

SPECIFICATIONS

Input impedance:	1 M Ω
Output impedance:	100 K Ω
Controls:	HIGH, MIX, LOW, FOOTSWITCH
Indicator:	LED
Connectors:	IN, OUT, DC input (9 V)
Power requirements:	9 V PP3 or 9 V DC supply (optional)
Power consumption:	15 mA
Dimensions (W x H x D):	120 x 60 x 120 mm



AUTOMAT

Two effects in one box - the Palmer PEAUTO is an auto wahwah and distortion pedal in one. Featuring the familiar distortion circuitry of the Palmer PEDIST and an additional auto wah, the PEAUTO offers a gamut of sounds from gentle to hard, from mellow thickness to the ultimate wall of distortion.

SPECIFICATIONS

Input impedance:	470 K Ω
Output impedance:	100 K Ω
Controls:	TONE, GAIN, WET / DRY, LEVEL, MIX, Q-FACTOR, FOOTSWITCH, HP, BP, LP, DRIVE
Indicator:	LED
Connectors:	IN, OUT, DC input (9 V)
Power requirements:	9 V PP3 or 9 V DC supply (optional)
Power consumption:	14mA
Dimensions (W x H x D):	120 x 60 x 150 mm



TIMEPRESSOR

The all-analog unit provides a wide range of rich vintage-sounding delays up to 700ms. With its classic lo-fi vibe, the TIMEPRESSOR recreates that warm old-school mojo unobtainable from digital delays. The addition of a compressor takes the world of delays to a whole new level. The unique pre/post delay switching allows you to influence the delay behavior in novel ways to produce amazing and unusual sonic spaces.

SPECIFICATIONS

Input impedance:	1 M Ω
Output impedance:	100 K Ω
Controls:	RATE, REPEAT, TONE, THRESHOLD, MIX, PRE/POST, LEVEL, FOOTSWITCH
Indicator:	LED
Connectors:	IN, OUT, DC input (9 V)
Power requirements:	9 V PP3 or 9 V DC supply (optional)
Power consumption:	20 mA
Dimensions (W x H x D):	120 x 60 x 140 mm



MUTTERSTOLZ

"Mutterstolz" is the German word for mothers' pride. This is indeed a pedal we are truly proud of! Never have we played a distortion effect with so much warmth and life. This all tube pedal is a true revelation for every distortion lover! The sound can be taken from a natural clean boost right up to a creamy rich distortion. The heart of this pedal, the ECC83 tube, delivers great tonal dynamics and works out all facets of your playing style. [Including 12V AC power supply.](#)

SPECIFICATIONS

Input impedance:	1 M Ω
Output impedance:	100 K Ω
Controls:	FOOTSWITCH, MOTHER, DIRT, DESTRUCTION, COLOUR
Indicator:	LED
Connectors:	IN, OUT, DC input (12 V)
Power requirements:	12 V AC power supply (included)
Power consumption:	14 mA
Dimensions (W x H x D):	120 x 60 x 150 mm



FROHLOCKER

This special Bass Flanger pedal provides smooth state-of-the-art flanging that is rich in depth. Separate rate, depth and mix allow for a wide range of settings. The PAD switch allows you to use the unit with active and passive basses.

SPECIFICATIONS

Input impedance:	1 M Ω
Output impedance:	100 K Ω
Controls:	MIX, RATE, FOOTSWITCH, DEPTH, INPUT PAD
Indicator:	LED
Connectors:	IN, OUT, DC input (9 V)
Power requirements:	9 V PP3 or 9 V DC supply (optional)
Power consumption:	15 mA
Dimensions (W x H x D):	120 x 60 x 120 mm



UNTERTON

The PEBUNT - Unterton is a special type of octaver pedal for bass. It can provide straight octave effects but can also create distorted and "weird" octave sounds with rich overtones and an interesting life of its own. The PAD switch allows you to use the unit with active and passive basses.

SPECIFICATIONS

Input impedance:	1 M Ω
Output impedance:	100 K Ω
Controls:	HIGH, MIX, LOW, FOOTSWITCH, INPUT PAD
Indicator:	LED
Connectors:	IN, OUT, DC input (9 V)
Power requirements:	9 V PP3 or 9 V DC supply (optional)
Power consumption:	15 mA
Dimensions (W x H x D):	120 x 60 x 120 mm



HERRENCHOR

The Herrenchor provides a smooth classic chorus effect. This special Bass Chorus has been especially tuned for the use with bass guitars. The PAD switch allows you to use the unit with active and passive basses.

SPECIFICATIONS

Input impedance:	1 M Ω
Output impedance:	100 K Ω
Controls:	DEPTH, FOOTSWITCH, RATE, INTENSITY
Indicator:	LED
Connectors:	IN, OUT, DC input (9 V)
Power requirements:	9 V PP3 or 9 V DC supply (optional)
Power consumption:	20 mA
Dimensions (W x H x D):	120 x 60 x 120 mm



UEBERTREIBER

The Palmer Uebertreiber is an Overdrive especially designed for bass guitars. The Clean control mixes your original signal in with the overdriven signal to maintain attack and definition. The pedal can also be used as a booster with the clean control all the way up and the gain control at 0. With the clean control at 0, the PEBUT provides all the sounds of a classic overdrive effect. The PAD switch allows you to use the unit with active and passive basses.

SPECIFICATIONS

Input impedance:	1 M Ω
Output impedance:	100 K Ω
Controls:	GAIN, CLEAN, TONE, LEVEL, INPUT PAD, FOOTSWITCH
Indicator:	LED
Connectors:	IN, OUT, DC input (9 V)
Power requirements:	9 V PP3 or 9 V DC supply (optional)
Power consumption:	12 mA (9 V DC)
Dimensions (W x H x D):	120 x 60 x 140 mm

BAZZ

The BAZZ is a special fuzz pedal for basses. This thing can generate extremely mean and aggressive fuzzy bass tones - this pedal is BAD! In addition the BAZZ has mid-boost switch, making it even meaner. The PAD switch allows you to use the unit with active and passive basses.

SPECIFICATIONS

Input impedance:	1 M Ω
Output impedance:	100 K Ω
Controls:	VOLUME, TONE, FUZZ, INPUT PAD, MID BOOST, FOOTSWITCH
Indicator:	LED
Connectors:	IN, OUT, DC input (9 V)
Power requirements:	9 V PP3 or 9 V DC supply (optional)
Power consumption:	12 mA (9 V DC)
Dimensions (W x H x D):	120 x 60 x 140 mm



DEEPRESSOR

The Palmer DEEPRESSOR controls the dynamics of your guitar signal for increased punch and sustain. The PEBDP has been especially developed for bass guitars, it can produce a warm, punchy and sustained tone. If you crank the level all the way up, a gentle warm distortion will kick in - more than a normal compressor.

SPECIFICATIONS

Input impedance:	1 M Ω
Output impedance:	100 K Ω
Controls:	LEVEL, ATTACK, SUSTAIN, INPUT PAD, FOOTSWITCH
Indicator:	LED
Connectors:	IN, OUT, DC input (9 V)
Power requirements:	9 V PP3 or 9 V DC supply (optional)
Power consumption:	12 mA (9 V DC)
Dimensions (W x H x D):	120 x 60 x 140 mm



OCTOBUS 8-CHANNEL LOOP SWITCHER

The Palmer OCTOBUS is a high-performance loop switcher for effects pedals. This central switcher lets you control up to 8 different effects. Thirty-two programmable presets let you determine at will which effects are included in the signal path.

SPECIFICATIONS

Number of loops:	8
Switching function:	output switcher, input switcher
Inputs:	1 x 6.3 mm Jack
Input impedance:	1 M Ω
Outputs:	1 x 6.3 mm Jack
Output impedance:	100 K Ω
Transformer isolated outputs:	no
Display:	LED display, bank
Controls:	store, bank select, preset, edit
Power supply:	9 V DC power supply
Power consumption:	300 mA
Cabinet material:	sheet steel
Cabinet / Housing surface:	powder coated
Dimensions (W x H x D):	455 x 110 x 45 mm
Weight:	2 kg
Accessories (included):	power supply
Features:	true bypass

POCKET ROOT EFFECTS

MINI EFFECT PEDALS

POCKET ROOT EFFECTS

Combining the original Palmer Root Effects circuitry and a smaller size the Pocket Root Effects series delivers classic sounds while saving valuable pedalboard real estate. Best of all, the Pocket line's prices have been slashed by more than 30% without compromising performance.

Measuring 60 x 55 x 100 mm only, the redesigned enclosures are made from powder coated 19 gauge steel. They feature heavy duty plastic control knobs, rugged footswitches and convenient pedalboard mounting provisions.



FLANGER
Art.No. PEPFLA



PHASER
Art.No. PEPHAS



BOOSTER
Art.No. PEPBOOST



FLANGER
Art.No. PEPDOD

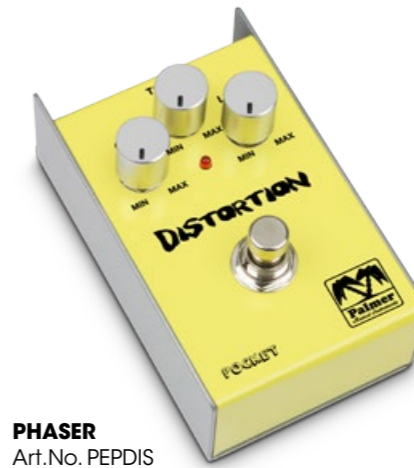

PHASER
Art.No. PEPDIS



BOOSTER
Art.No. PEP TREM



FLANGER
Art.No. PEPDEL



PHASER
Art.No. PEPCHOR



BOOSTER
Art.No. PEPREVERB



PALMER PEDALBAY

VARIABLE PEDALBOARDS



LIGHTWEIGHT VARIABLE PEDALBOARDS WITH PROTECTIVE SOFTCASE

The Palmer Pedalbays are lightweight aluminium pedalboards for stompbox effects with adjustable height and tilt. The crossbars are covered with loop tape, and the inner braces are relocatable to accommodate a variety of pedal footprints. For convenient, space-saving power supply mounting the Pedalbays feature four brackets underneath, elastic retaining straps are included.

The Palmer Pedalbays come with adhesive backed hook tape and a high-quality padded softcase with accessory compartment and comfortable shoulder strap.

SPECIFICATIONS

Product type:	Pedalboard
Material:	aluminium
Surface:	powder coated
Width of the Cross Bars:	50 mm
Accessories (included):	soft carrying case with shoulder strap, approx. 3m hook tape, 2x black elastic bands, allen key
Features:	adjustable cross bars, height-adjustable

AVAILABLE SIZES:



PEDALBAY 50S	PEDALBAY 40	PEDALBAY 60	PEDALBAY 60L	PEDALBAY 80
WIDTH: 50 CM DEPTH: 13.5 CM HEIGHT: 3.5 CM 2 CROSSBARS	WIDTH: 45 CM DEPTH: 30.5 CM HEIGHT: 7 CM 4 CROSSBARS	WIDTH: 60.5 CM DEPTH: 30.5 CM HEIGHT: 7-8.5 CM 4 CROSSBARS	WIDTH: 60 CM DEPTH: 39 CM HEIGHT: 7 CM 5 CROSSBARS	WIDTH: 80 CM DEPTH: 39 CM HEIGHT: 7 CM 5 CROSSBARS

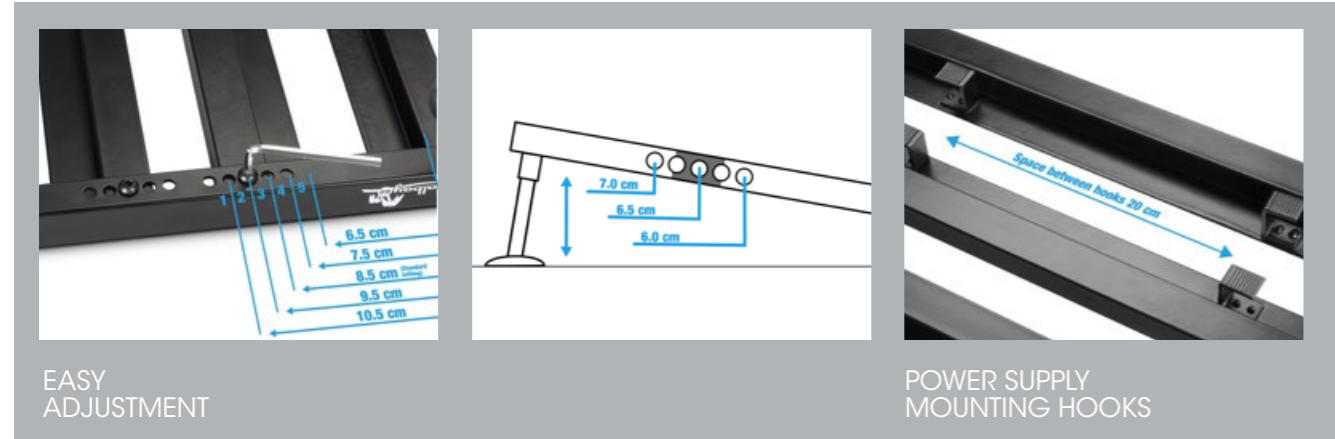

PEDALBAY HNL
HOOK AND LOOP FASTENER
50 mm WIDE, 1m

SUITABLE POWER SUPPLIES:
PWT08
PBATPACK4000
PBATPACK8000
PWT05 (only if the middle crossbar is moved down, not suitable for PEDALBAY 50S)



PALMER POWER SUPPLIES



POWER
SUPPLIES

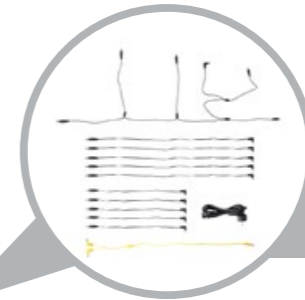

CABLE SET
INCLUDED



PWT 05 MK2 UNIVERSAL POWER SUPPLY - 5 OUTPUTS

With a stable 250 mA on each of the five center negative barrel style outlets the compact Palmer PWT 05 MK2 is most suited to virtually any pedalboard size. To deliver clean DC power to your pedals and eliminate ground loops between them and the associated hum the outlets are isolated.

The PWT 05 MK2 is protected against overloading and comes with 25 and 50 cm long connection cables, as well as two Y-cables. The first one, with a black connector, connects two 9 V outputs to increase the current intensity to a massive 500 mA, the other one, with a white connector, connects two 9 V outputs to double the voltage to 18 V. Also included is a 1-into-5 daisy chain that lets you power five pedals from one output if their total current draw does not exceed 250 mA. The rugged enclosure of the Palmer PWT 05 MK2 provides mounting and cable relief options while the IEC mains inlet and voltage selector enable worldwide use.

SPECIFICATIONS

Product type:	multiple power supply
Mains connector:	IEC socket
Input voltage:	230 V
Outputs:	5
Output connectors:	2.1 x 5.5 mm
Output voltage:	9 V
Max. output current:	each output 250 mA
Isolated outputs:	yes
Polarity:	center negative
Cord length:	25 - 50 cm
Indicators:	Overload, Power
Controls:	voltage selector switch, mains switch (on/off)
Dimensions (W x H x D):	105 x 45 x 140 mm
Weight:	1.5 kg



BATPACK 4000 / BATPACK 8000 RECHARGABLE POWER SUPPLY

Available in two versions, the Palmer Bat Packs are purpose-designed to power multiple stompboxes and pedalboards. They feature high grade, long-life lithium polymer batteries providing 500 mA each from two 9 volt DC center negative barrel outputs that are fully regulated and isolated. Recharging the 4,000 mAh capacity Bat Pack 4000 takes approximately four hours and twice that for the 8,000 mAh Bat Pack 8000. Both come in low-profile all-metal enclosures with 5-segment battery status indicators and convenience type A USB port for charging smartphones or tablets. Run time depends on your pedals' current draw.

- Rechargeable 9V DC Power Supply
- Perfect for Palmer Pedalbays
- Low-profile all-metal enclosure with 12 mounting holes
- High grade long-life lithium polymer battery
- 2 isolated and regulated 9V DC outputs
- Type A USB port for charging smartphones or tablets
- Short circuit protection
- 5-segment LED battery status indicator
- Fully functional while recharging



SPECIFICATIONS

Art. No.:	PBatpack 4000	PBatpack 8000
Product type:	power supply	power supply
Type:	Battery power supply	Battery power supply
Mains connector:	External power supply	External power supply
Input voltage:	12 VDC/2A	12 VDC/2A
Outputs:	3	3
Output connectors:	2.1 x 5.5 mm, USB type A	2.1 x 5.5 mm, USB type A
Output voltage:	9 VDC, 5VDC	9 VDC, 5VDC
Max. output current: 9V outputs:	500 mA, 5V output: 1A	500 mA, 5V output: 1A
Isolated outputs:	yes	yes
Polarity:	center negative	center negative
Indicators:	Battery status	Battery status
Controls:	Power (on/off)	Power (on/off)
Battery capacity:	4000 mAh	8000 mAh
Battery type:	Lithium Polymer	Lithium Polymer
Charging time:	4h	8h
Battery operation time at maximum load:	4h	8h
Dimensions (W x H x D):	195 x 25 x 83 mm	195 x 25 x 83 mm



CABLE SET INCLUDED



PWT 08 UNIVERSAL POWER SUPPLY - 8 OUTPUTS

- Fully regulated universal pedalboard power supply
- 8 standard center negative outlets with 2,000 mA output total
- Two 9, 12 or 18 V switchable outputs
- Short circuit and overload protection for each outlet
- Bright power and outlet status LED indicators
- DC cables, Y cable and mains adapter included

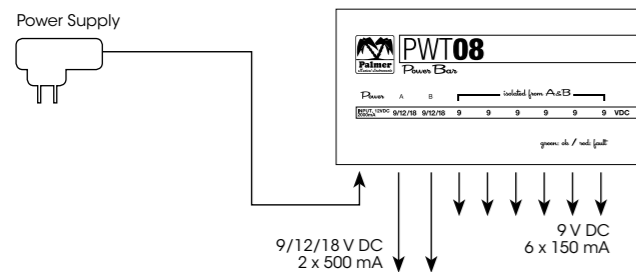

SPECIFICATIONS

Product type:	multiple power supply
Mains connector:	wall wart
Input voltage:	100 V - 250 V
Outputs:	8
Output connectors:	2.1 x 5.5 mm
Output voltage:	9 V
Max. output current:	2000 mA
Isolated outputs:	yes
Polarity:	center negative
Cord length:	25 - 50 cm
Indicators:	Power, Fault
Controls:	Output voltage selector
Dimensions (W x H x D):	140 x 312 x 80 mm
Weight:	0.3 kg

PW 9V 9V POWER SUPPLY

Power supply for all Palmer devices with a 9 V input connector and a maximum power consumption of 300 mA.

- Input Voltage: 220 - 240 V AC 50 Hz
- Output Voltage: 9 V DC, 300 mA regulated
- Polarity negative inside

110V VERSION AVAILABLE
(Art. No. PW9VUS)



PURIFIER DC VOLTAGE CLEANER

Designed especially for the use with effect pedals and pedalboards, the Purifier minimizes and removes noise induced by poor DC power adapter construction delivering clean DC power to your stompboxes. It provides standard 2.1 x 5.5 mm barrel jack connectors and automatically detects your DC power supply's polarity. The Purifier cleans any output voltage from 5 to 30 volts DC.

- Highly efficient DC power conditioner
- Removes noise induced by poor DC power adapters
- For all output voltages from 5 - 30 volts DC
- Automatic polarity detection
- Durable aluminium housing with convenient mounting holes

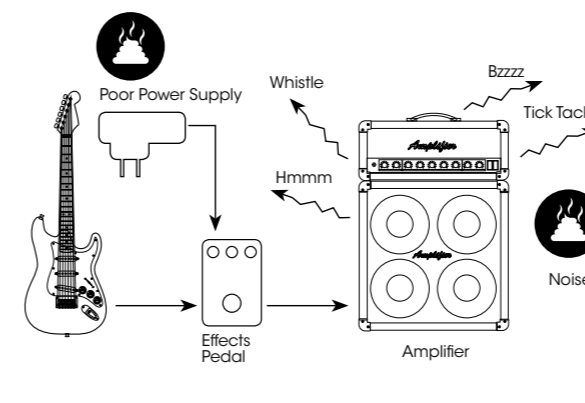

SPECIFICATIONS

Product Type:	Active DC Power Conditioner
Number of Channels:	1
Number of Inputs:	1
Input Connector:	2.1 x 5.5 mm barrel jack
Number of Outputs:	1
Output Connector:	2.1 x 5.5 mm barrel jack
Voltage Range:	5 - 30 V DC
Max. Electric Charge:	1 A
Polarity:	Automatic detection with LED indicator, red = center pos., green = center neg.
Current Draw:	2 mA
Protection Circuits:	PCB fuse
Housing Material:	Aluminium
Housing Finish:	Powder coated

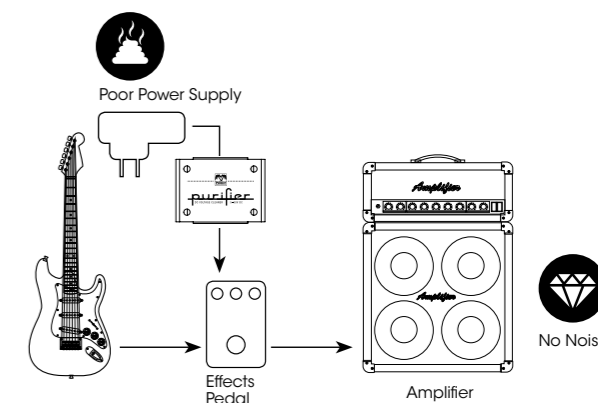

PWC 6 POWER CHAIN CABLE 1 TO 6

- Type: power distributor (Daisy Chain)
- Inputs: 1
- input connectors: Coaxial power connector 5.5 x 2.5 mm
- outputs: 6
- output connectors: Coaxial power connector 5.5 x 2.5 mm (9.5mm shaft length)
- max. total length: 2,3 m
- cable length between outputs: 350 mm

PALMER PREAMPS



POCKET AMP MK2 PORTABLE GUITAR PREAMP

In its new incarnation, the Palmer Pocket Amp MK 2 delivers an extended range of authentic tube amplifier tones from high headroom ultra clean to maxed out high gain distortion. With 3-position selector switches for amplifier design, gain structure and loudspeaker miking simulation the MK 2's hot rodded circuitry lets you easily configure vintage and modern sounds as well as your own while high performance op amps provide superior S/N ratio. For even more flexibility the Pocket Amp MK 2 sports master controls for drive and output level plus a 2-band EQ that has been carefully tailored for guitar applications.

Featuring a durable die cast aluminium enclosure with balanced XLR and unbalanced 6.35 mm outputs in addition to 3.5 mm AUX input and headphones jacks the Palmer Pocket Amp MK 2 is more than just the go-to tool for direct recording. It doubles as a practice amp, overdrive and distortion pedal, standard guitar DI box when bypassed and replaces your stage amp when used with a sound and monitor system. The Pocket Amp MK 2 works on a 9V battery or optional power adapter, e.g. Palmer PW9V.



SPECIFICATIONS

Product type:	guitar effect pedal
Technology:	solid state
Inputs:	1
Input connectors:	6.3 mm Jack
Input impedance:	1 MΩ
Outputs:	3
Output connectors:	3.5 mm jack, 6.3 mm Jack, XLR
Output impedance:	510 Ω
Channels:	1
Indicators:	on/off
Controls:	level, mic position, mode, Treble, ground lift, Gain, Bass, Drive, amp select
FX loop:	no
Operating voltage:	9 V DC, 9 V block
Cabinet material:	die-cast aluminium
Dimensions (W x H x D):	100 x 55 x 100 mm
Weight:	0.36 kg

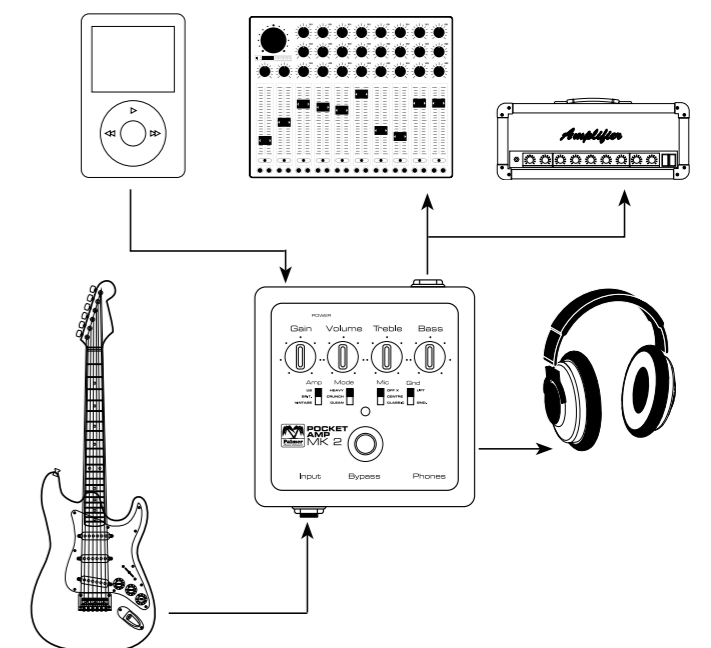



POCKET AMP BASS PORTABLE GUITAR PREAMP FOR BASS GUITARS

Providing extensive sound shaping options for active and passive bass guitars, the Pocket Bass Amp is a multi-purpose effects pedal and preamp that's perfect for gigging, recording and practising. It features clean, overdrive and fuzz modes with adjustable drive and saturation, a 3-band EQ with semi-parametric mid control that is specifically tuned for bass guitar and vintage or modern cabinet simulation. A blend control allows you to mix the direct and effected signals.

The Pocket Bass Amp provides an insert for external effects, 3.5 mm stereo line input and headphones output for quiet play-along practice and a footswitch-assignable thru jack for silent tuning. Enabling DI applications, the balanced XLR output is pre or post effect switchable. The Pocket Bass Amp requires a 9 volt battery or power adapter and comes in a rugged diecast enclosure with heavy duty long-life footswitch, convenient LED status indicators and ground lift.

FEATURES

- Multi-purpose bass effects pedal and preamp
- Works with any bass rig, power amp, mixing desk and as headphones amp
- Pad switch for use with active and passive basses
- Clean, overdrive and fuzz modes
- Drive and saturation controls
- 3-Band EQ with semi-parametric mid control
- Vintage and modern cabinet simulations
- Blend control for wet and dry signal mixing
- 3-pin XLR for balanced DI, pre or post effect switchable
- Footswitch-assignable thru (tuner) output
- Insert, stereo line input and ground lift

SPECIFICATIONS

Product Type:	Effects pedal
Type:	Preamp/preamplifier
Technology:	Solid state
Number of Inputs:	2
Input Connections:	6.3 mm jack
Input Impedance:	1 MΩ
Number of Outputs:	4
Output Connections:	XLR, 2 x 6.3 mm jack, 3.5 mm jack
Output Impedance:	XLR: 510 ohm, TRS: 10 k ohm
Output Level:	XLR: +4 dBu, TRS: 0 dBV
Number of Channels:	1
Display Elements:	On/Off, Signal/Peak
Controls:	Bass, Mid level, Mid Frequency, Highs, Drive, Blend, Saturate, Volume, Mode, DI, pre/post, Footswitch, mute/bypass, Cabinet mode, input pad, ground lift
FX Loop:	yes
Power Supply:	9 V DC, 9 V block battery
Cabinet Material:	die-cast aluminium
Dimensions (W x H x D):	100 x 55 x 100 mm
Weight:	0.4 kg

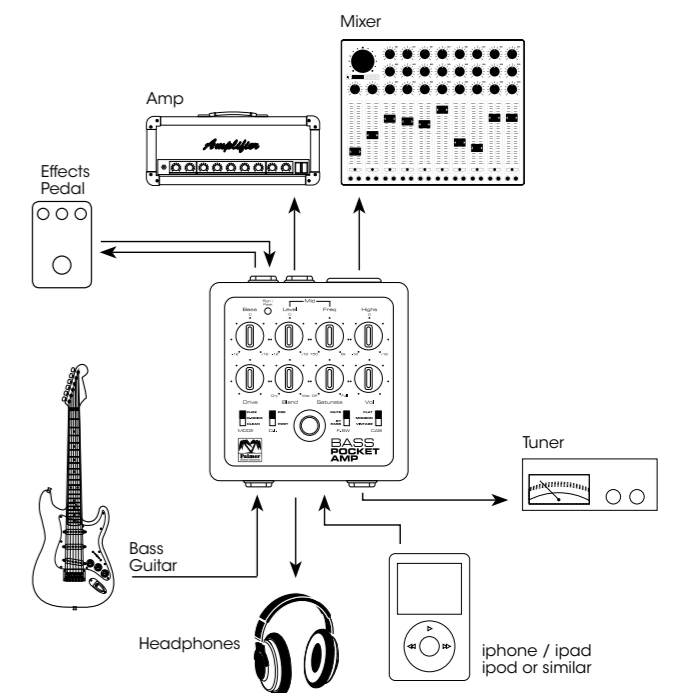

PALMER SWITCHERS



TINO-S DUAL GUITAR AMP TO SINGLE SHARED CABINET SWITCHING SYSTEM

The Palmer TINO system is an AB switcher for two guitar amps sharing a single speaker cabinet that is suitable for both tube and solid state amplifiers. Amp 1 or 2 are activated by a front panel pushbutton or an optional latching footswitch connected to the rear panel remote jack.

The TINO system feeds the input signal to the selected amplifier while routing its output to the cabinet. The deselected amp is muted and connected to a dummy load to prevent output transformer and tube damage. Switching is glitch-free without dropouts, pops or clicks.

The TINO includes a transparent unity gain buffer converting the high impedance guitar signal to low impedance to minimize interference. The outputs are transformer isolated with ground lift switches eliminating earth loop hum.

The Palmer TINO can also be used for AB switching combo amps or head and cab setups. A center negative 9V adapter is included to power the system.

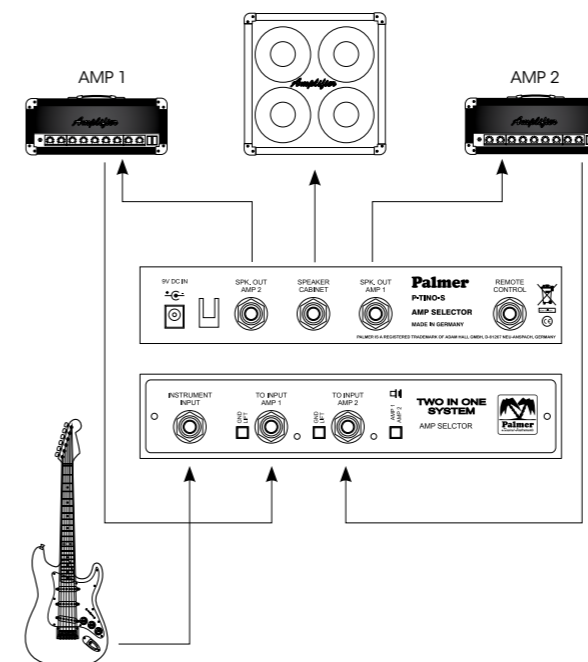

SPECIFICATIONS

Product type:	switch
Type:	amp switcher
Switching function:	output switcher
Input connectors:	2 x 6.3 mm Jack
Input impedance:	10 M Ω
Output connectors:	1 x 6.3 mm Jack
Output impedance:	10 k Ω
Transformer isolated outputs:	no
Display:	channel number
Controls:	ground lift, channel switching
Operating voltage:	9 V DC power supply
Power consumption:	130 mA
Cabinet material:	sheet steel/aluminium
Cabinet / Housing surface:	powder coated/anodized
Dimensions (W x H x D):	222 x 44 x 175 mm
Accessories (included):	9 V DC power adapter
Weight:	1,6 kg



TRINITY INSTRUMENT SELECTOR

Three in one is the main motto here. The idea is to avoid having to plug and unplug different guitars in to one amp - as you may know, this is not done quickly and easily without causing considerable noise. With the TRINITY - box you can selectively switch three instruments on to one output. In addition each input can be boosted up to +12dB with an individual pot. This helps to balance out differences in level between the instruments without having to change the amps settings. The TRINITY also features a tuner out. Pressing and holding the footswitch of a channel mutes the main output but not the tuner out - ideal for tuning your guitar.

Optional 9VDC Power Supply (Art. No.: PW9V) available

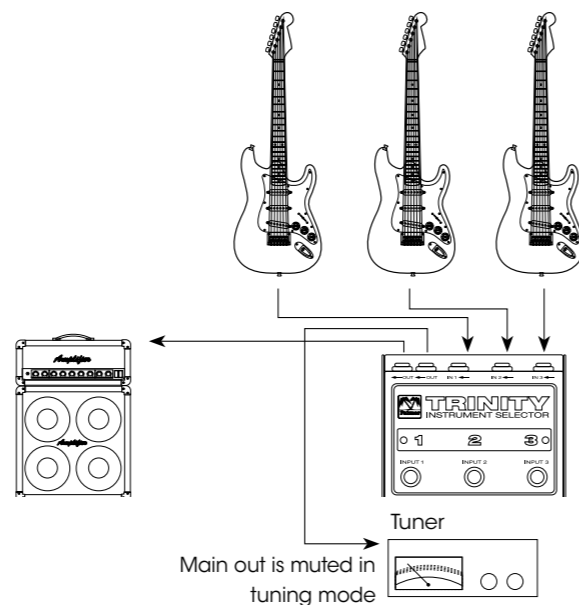

TRIAGE AMP SELECTOR

With the Triage you can selectively route one guitar signal on to three different amps per footswitch. A fourth switch (SIDEKICK) makes it possible to select multiple amps simultaneously.

- All outputs are transformer isolated, so that no ground loop humming can occur.
- Each output is equipped with a buffer amp for the volume, meaning the signal can be boosted by up to 12 dB (quadruple the amplification).
- Each output has a phase switch with which you can flip the phase of the signal by 180°. This is a very useful feature since it prevents cancellations that can occur when two amps with different phasing are played simultaneously.
- Each output has a ground lift switch

Optional 9VDC Power Supply (Art. No.: PW9V) available

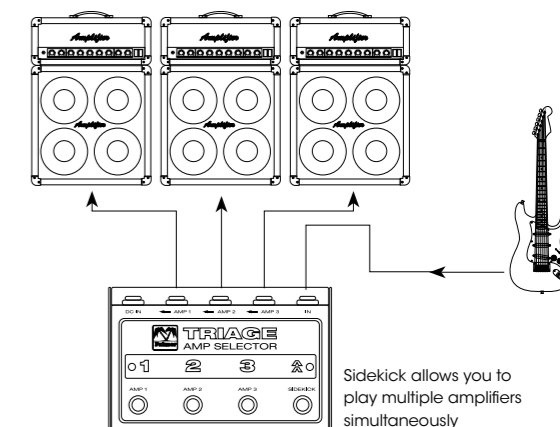



BUFF BUFFER & BOOSTER

The Palmer PEBUFF is a Buffer and Booster for electrical instruments. Amplifying the guitar signal before it goes to the input of a tube amplifier opens a whole world of new sounds. The device can also be used as a cable driver for longer distances or larger pedalboard setups.

SPECIFICATIONS

Model Name:	PEBUFF
Input impedance D / S:	1 MΩ / 4 MΩ
Output impedance:	150 Ω
Frequency Response:	20 Hz - 10 KHz
Max. Level / Gain:	5 V / 13 dB
Power requirements:	9V DC or 9V PP3 battery
Power consumption:	10 mA (9 V DC)
Dimensions (W x H x D):	100 x 61 x 120 mm
Weight:	700 g



PEABI BALANCED INPUT SWITCHER

- Passive switcher
- Switch between two inputs to one output
- Latching switch
- Sturdy construction
- Ground lift and Pad for each input
- LED to indicate selected channel

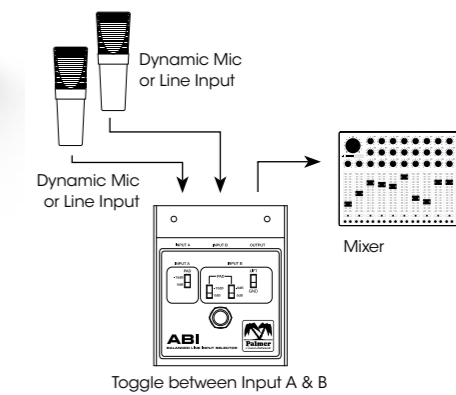

DMS DYNAMIC MIC SWITCHER

With the Palmer DMS (Dynamic Mic Switcher) you can switch a dynamic microphone between two inputs. The range of applications is vast:

- Switch your vocal mic between the FOH mixer and the monitor mixer - this will allow you to talk exclusively to the band or the monitor mixing engineer.
- Sound variation. Send the two outputs of the DMS to two channels of the FOH mixer, adjust the channels differently (for example, adjust the EQ to get a telephone effect). This will allow you to switch between two microphone sounds on stage at your own leisure.
- You can use the DMS to switch the microphone between two different rooms/zones

The Palmer DMS is a passive unit and is exclusively for dynamic microphones. The switch on the DMS is momentary.

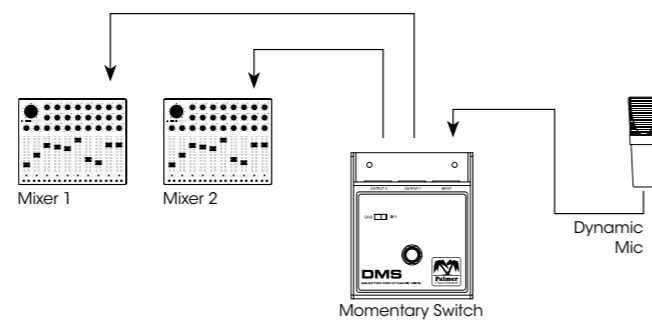

PEABO BALANCED OUTPUT SWITCHER

- Passive switcher
- Switch one input to two outputs
- Latching switch
- Sturdy construction
- Ground lift and Pad for each input
- LED to indicate selected channel

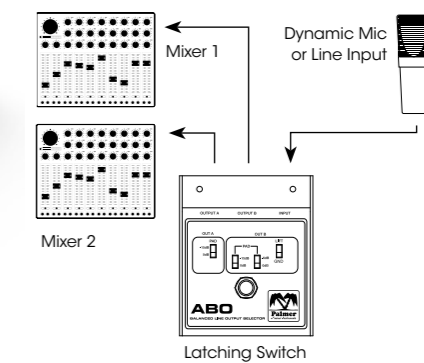



PFFX DUAL EFFECTS LOOP SWITCHER

The Palmer PFFX allows you to individually switch on or off two effect loops, or connect both in series and thus supports customised set-ups, e.g. for rhythm and solo sounds. For the FX 2, a mute function for connecting a tuner can be selected and a ground lift switch helps to avoid ground loops. The PFFX can also be inserted in the effects loop of an amplifier. The flexible true bypass pedal is completely passive; for using the LED displays, a 9V block battery or an AC adapter with negative internal contact such as the Palmer PW9V are required.

- Switching between two effects loops.
- Bypass function for effects
- True Bypass

SPECIFICATIONS

Model Name:	PFFX
Type:	2-channel loop switcher
Switching Functions:	input switcher, output switcher
Number of In- / Outputs:	3 / 3
In- / Output Connections:	6.3 mm jack
Indicators:	Loop On/Off
Controls:	channel switch, mute, ground lift
Power Supply:	9 VDC power adapter
Power Consumption:	40 mA
Housing Material:	sheet steel
Housing Surface:	powder coated
Dimensions (W x H x D):	120 x 65 x 120 mm
Features:	True Bypass

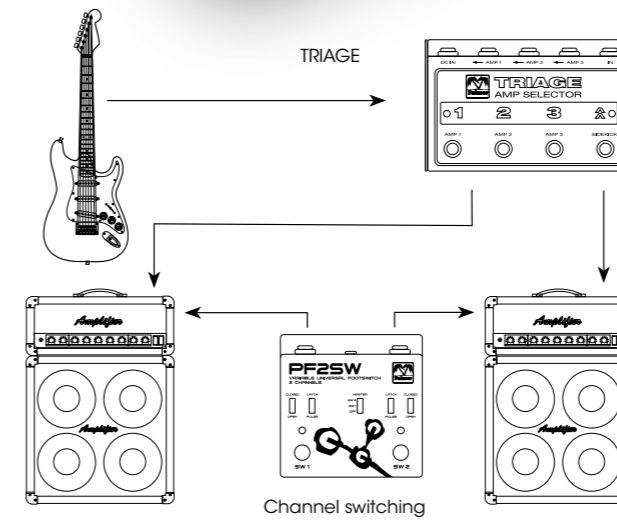
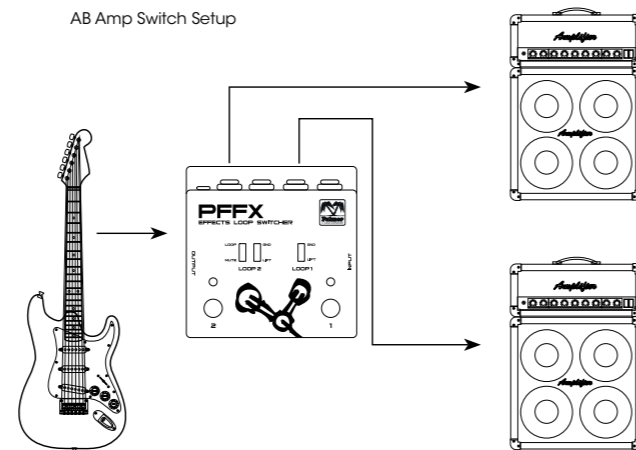
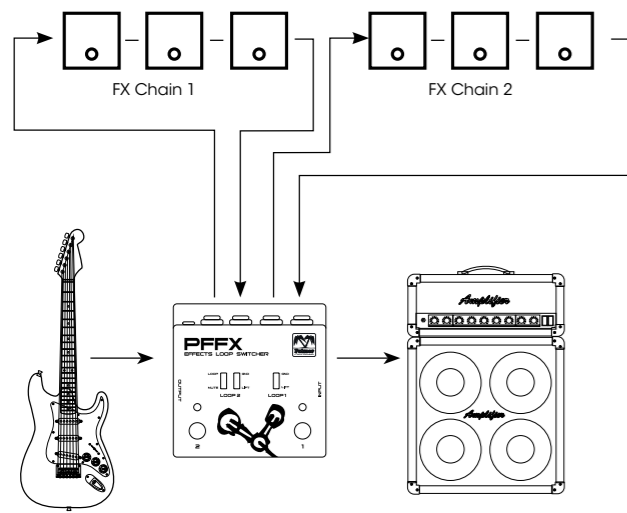

PF 2 SW UNIVERSAL FOOTSWITCH

The Palmer PF2SW is a variable dual footswitch for all devices with a footswitch port. It is suitable for channel switching of amplifiers, to turn on and off built-in and external effects, and can independently control two devices; bright LEDs indicate the switching status. The two circuits of the PF2SW can be adjusted individually to the respective function of the connected devices. To do this, the sliding controller chooses between contact closure and electronic impulse as well as open or closed position of the relay, a further controller selects one of the two footswitches as master for simultaneous switching of both circuits. In most applications, the PF2SW can be connected using conventional 6.35 mm jack cables.

- 2-channel universal footswitch
- Variable switching functions
- Suitable for all devices with a footswitch port
- Switching via contact closure or electronic pulse
- Open or closed relay position

SPECIFICATIONS

Model Name:	PF2SW
Type:	2-channel switcher
Number of Inputs:	0
Number of Outputs:	2
Output Connections:	6.3 mm jack
Display Elements:	switching, switching type, link
Controls:	channel on/off
Power Supply:	9 VDC power adapter
Power Consumption:	50 mA
Housing Material:	sheet steel
Housing Surface:	powder coated
Dimensions (W x H x D):	120 x 65 x 120 mm

PF 1 UNIVERSAL 1-CHANNEL FOOTSWITCH



This simple but robust single-channel switch can be used universally. Whenever a change of channel or function via foot switch is required. For example, the PF1 can be used to switch the channel of a guitar amp or activate a particular function on a keyboard. The switch is latching, not spring return. To connect, a standard Mono Jack cable is sufficient.

SPECIFICATIONS

Product type:	passive switch
Output connectors:	1 x 6.3 mm Jack
Controls:	footswitch
Switch type:	latching
Cabinet material:	sheet steel
Cabinet / Housing surface:	powder coated
Dimensions (W x H x D):	55 x 60 x 65 mm
Weight:	0,25 kg

PALMER SPEAKER SIMULATORS

SPEAKER
SIMULATORS

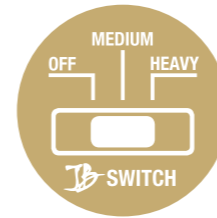

max out your sound with the exclusive "right in your face" JB switch



take your tone to any venue and studio for consistent live sound and tracking



say goodbye to miking and mic-related problems such as leakage and low-end rumble



add authentic speaker and cabinet flavors for frequency compensated balanced DI



PDI 03 JB THE JOE BONAMASSA SIGNATURE GUITAR SPEAKER SIMULATOR DI

The PDI-03 JB Speaker Simulator is a professional passive DI box for guitar amps. Providing a frequency compensated, transformer balanced direct feed to mixing consoles or soundcards it connects between the amplifier output and loudspeaker or equivalent dummy load. The PDI-03 JB has been developed for live, studio and home recording applications to eliminate the need for time consuming mic placement and mic-related problems.

Designed to Joe Bonamassa's high standards for a huge but tightly focused tone the exclusive JB switch brings the output signal to the fore and takes it "right in your face." The PDI-03 JB's dual speaker simulation filters are carefully voiced to authentically replicate the frequency response of classic and contemporary loudspeakers and cabinets. The unit's input sensitivity is adjustable for amps up to 200 watts or line and instrument level equipment.

Delivering consistent guitar tone from show to show the PDI-03 JB can also be used to add realistic speaker flavors to preamps and dirt boxes in direct recording applications. The rugged powder coated steel enclosure features high quality Amphenol connectors and a ground lift to remove hum resulting from earth loops.

For amp DI WITHOUT speakers a dummy load with matching impedance must be connected. We recommend the Palmer Power Attenuator PDI06 and the Palmer Dual Load Box PLB2X8.

- passive guitar amp DI box with speaker simulation
- for live and direct recording applications
- consistent guitar tone in any venue or studio
- exclusive JB switch for a huge, maxed-out tone
- dual analog filters for variable frequency compensation
- authentic guitar loudspeaker and cabinet sounds
- ground lift to remove earth loop hum
- eliminates miking and mic-related issues
- connects between amps up to 200W and speaker or dummy load
- also works with preamps and dirt boxes

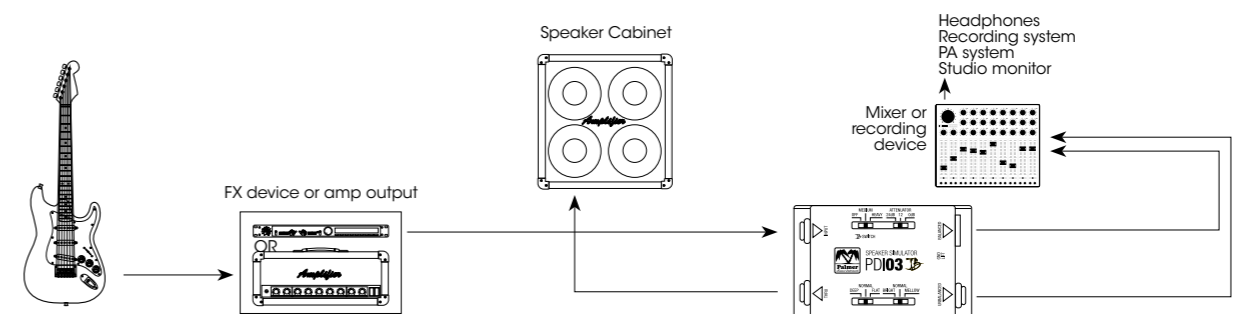



PDI 09
PASSIVE DI BOX WITH SPEAKER SIMULATION

PDI 09 "THE JUNCTION" A DI box designed especially for guitarists, for use with line level preamps, or to be connected between amp and speaker, enabling direct-to-mixing-desk recording without microphones. Integrated filter circuits simulate the authentic "speaker" sound. Tone can be varied between "Mellow", "Normal", or "Bright".

SPECIFICATIONS

Input:	1/4" Jack with parallel "THRU" socket
Output:	XLR/M transformer balanced
Attenuator:	(Level switch) 0dB for line signals, -15 dB for small amps up to 10 W, -30 dB for large amps up to 200 W
Power supply:	No power supply or battery necessary

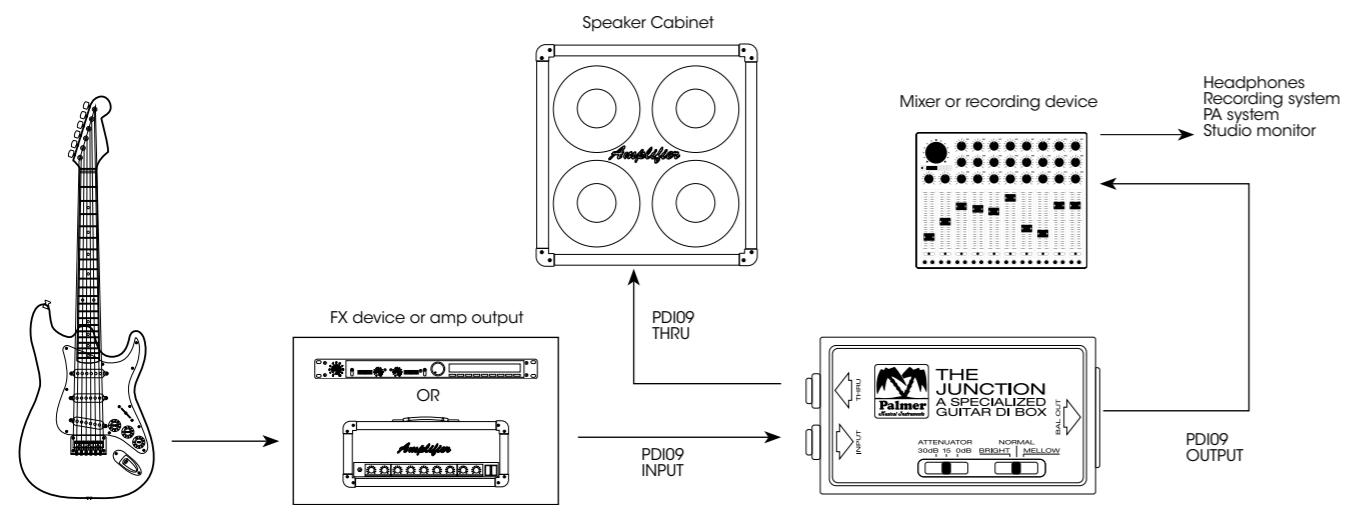

PGA 04
SPEAKER SIMULATOR WITH LOAD BOX

PGA 04 ADIG-LB is a successor to our legendary speaker simulator (PDI03), which has conquered recording studios worldwide and is used by renowned artists such as Keith Richards/Rolling Stones, Alex Lifeson/Rush, Joe Bonamassa, Eddie Van Halen, Def Leppard and The Black Keys only to name a few. The PGA 04 is connected in place of a speaker cab, facilitating direct-to-mixing-desk recording, thereby eliminating undesirable "noise pollution" through "cranked" amplifiers. An extensive and unique filter section lets you shape the sound beyond the boundaries of common EQ circuits. The PGA04 works without any additional mains power. The PGA04 features a 100W loadbox allowing you to play your tube amplifier without a speaker connected. The unit is available in 2, 4, 8 and 16 Ohms Versions.

SPECIFICATIONS

Loadbox:	1/4" Jack input with parallel "THRU" socket for speaker operation
Max. input load:	100 W
Input level display:	6 LED's
Output:	2 x 1/4" Jack, unbalanced, floating ground, 1 x balanced XLR output
Output impedance:	Jack: 10 KΩ, XLR: 600 Ω
Level:	unbalanced 0dBu, balanced -10 dBu at 25 W input
Controls:	Volume Filter, LOW, HIGH, LITE/BROWN-switch for tone shaping. Full range volume for unfiltered signal.

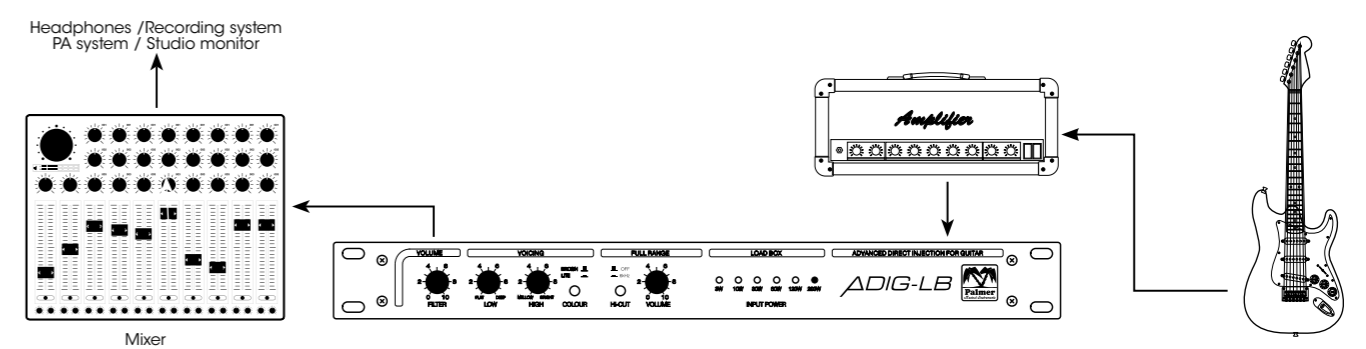

AVAILABLE IN 4, 8 AND 16 OHMS



PDI 03 CLASSIC SPEAKER SIMULATOR WITH LOAD BOX

The PDI 03 is a passive device that takes the signal from an amp's speaker output, and converts it to balanced and unbalanced signals suitable for feeding the input of a mixer, recorder, or power amp. The unit is available in 2, 4, 8 and 16 Ohms Versions. Four additional unfiltered 1/4" outputs with a separate level control for incorporating effects or similar units into the setup. Two three-way filter switches allow you to adjust high-end response to simulate „American,“ „British,“ or „bright“ speaker types, and adjust low-end response to simulate closed-back 4x12, „neutral,“ or open back 2x12 speaker cab sounds.

SPECIFICATIONS

Input:	19" / 1 U passive DI-Box for Loudspeaker Level, Integrated Load Box and Filter Section Rating: max Input Power 100 W RMS, THRU Jack (Speaker signal link) socket with break function disconnecting the internal load box
Filtered output:	1 unbal. jack socket, 1 bal. XLR/m socket PIN 2 hot, all with floating ground Output Impedance: Unbalanced 10 kΩ nom. Balanced 600 Ω nom. Outputs via isolating transformer, GND switch connecting input/output ground. 4 unbalanced Line Outputs - Output impedance 10 kΩ nom
Controls:	Separate volume controls for filter and line out.
Switches:	Low End - Deep, Normal, Flat. / High End - Bright, Normal, Mellow.

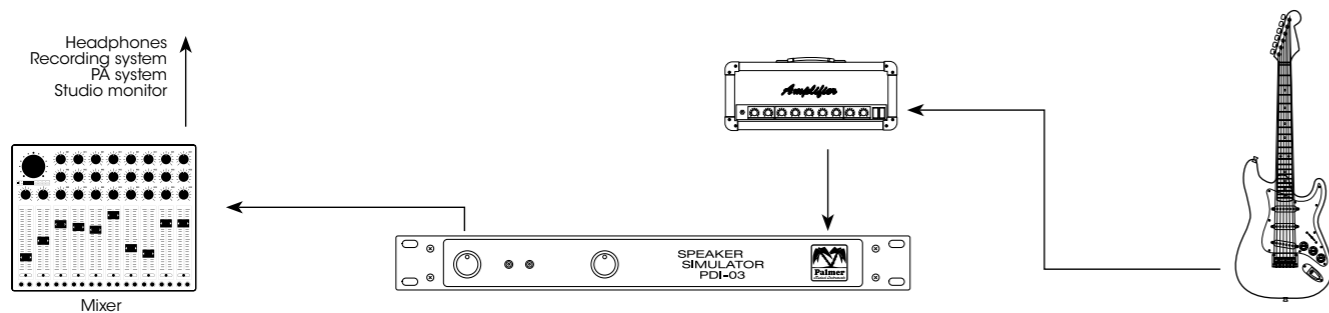

PDI 05 SPEAKER SIMULATOR - 2 CHANNELS

With its flexible potential applications, the PDI-05 is equally at home in the studio and home recording as well as onstage, e.g., in the racks of Rush or Def Leppard. Originally developed for the preamp/multieffect/power amp combination popular in the late eighties and nineties, this authentic reissue is also suitable for heads and combo amps. What's more - the precise frequency correction of the stereo speaker simulator turns overdrive and distortion pedals or multieffect units into a genuine preamp with an authentic sound. The PDI 05 lends digital keyboards and drum machines fullness and analogue warmth without complex and time-consuming post-processing at the mixing desk. A built-in headphone amplifier permits "environmentally-friendly" practicing; its high output power even permits direct connection of ordinary hi-fi speakers. The stereo speaker simulator is active; the power supply is permanently installed. It can also be operated in mono mode and with power amps (in this case, the power amp must always be connected to speakers or a corresponding load, for example the Palmer PDI 06 or PLB2X8 loadboxes). The PDI-05 makes conventional micing unnecessary and provides for a perfectly isolated signal without interference from other instruments and without feedback. With the reissue, pros and aficionados finally once again have a device at their disposal that has proven itself in more than 20 years of use, onstage and in the studio, around the world.

SPECIFICATIONS

Input / Input level:	Two independent channels, each channel: 1/4" Jack with parallel thru output. Input switchable between line/loudspeaker level
Output:	XLR/m and 1/4" Jack output with ground lift switch, 6.3 mm Phones output
Controls:	Filter Volume, Deep/Flat-switch, Bright/Mellow-switch, Phones Volume
Load box:	Optionally available (Palmer PLB2X8)
Power supply:	Internal power supply 230/115 VAC

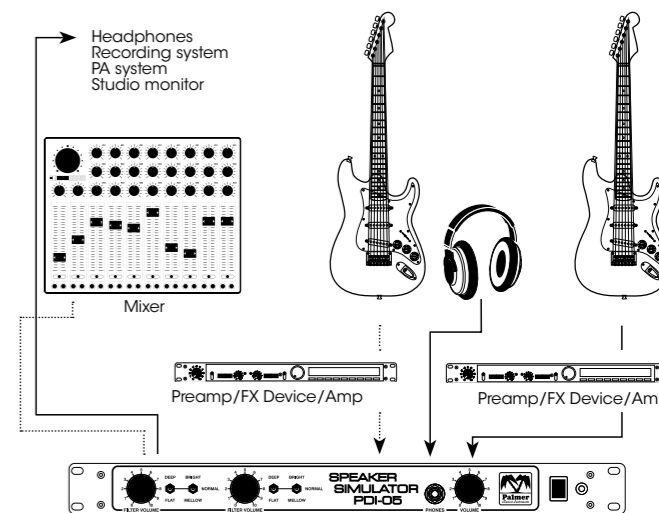

PALMER POWER SOAKS & LOAD BOXES



POWER SOAKS
& LOAD BOXES

PLB 2X8 DUAL LOAD BOX

The Palmer PLB2X8 is a dual-channel, strictly reactive load (load box). A load box is a substitute for a speaker. It ensures that tube amps are connected to the correct load on the output, thus eliminating the risk of amplifier damage.

The PLB2X8 is a perfect addition to speaker simulators that do not have a built-in load (load box) (for example: PDI09, PGA05 and PDI05).

The PLB2X8 is also useful in conjunction with guitar amps that have a line out or filter out connection. In this case, the PLB2X8 permits silent operation of the amplifier with simultaneous use of the line/filter output.

SPECIFICATIONS

Channels:	2
Input type:	unbalanced
Inputs:	2 x 6.3 mm Jack
Output type:	unbalanced
Controls:	mono/stereo mode
Display:	Input signal present
Dummy load impedance:	2 x 8 Ω / 1 x 16 Ω / 1 x 4 Ω
Max. load:	2 x 100 W / 1 x 200 W
Dimensions (W x H x D):	480 x 180 x 44,5 mm (19", 1 U)
Weight:	2,9 kg

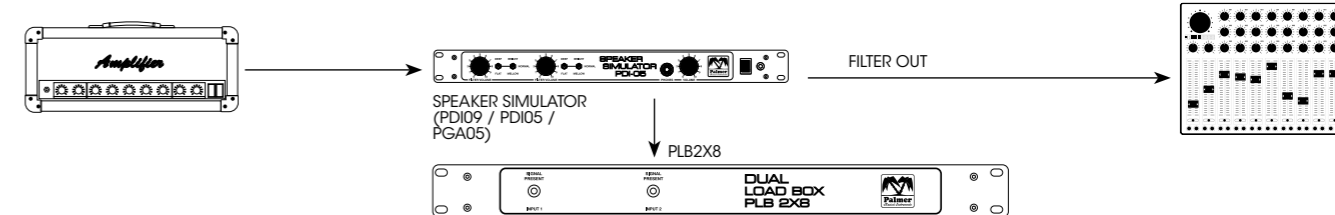

PDI 06 POWER ATTENUATOR / POWER SOAK

The PDI 06 is a power attenuator for live applications. The device is connected between the amplifier output and the speaker cabinet. It makes it possible to use the popular power stage distortion of tube amplifiers while reducing the associated high volume level. This permits practical volume reduction in six increments from 100% to 18% for stage and practice room situations. An additional Setting completely mutes the speaker; the PDI06 then functions as a LOAD BOX and absorbs the entire output power of the amplifier.

The total impedance of the speakers connected must equal the value shown on the PDI 06. For example: the outputs of a PDI06 that is specified for 8 ohms can be connected to one 8 ohm cabinet or two 16 ohm cabinets. The output of the (tube) amplifier is also set to 8 ohms.

SPECIFICATIONS

Maximum input power:	120 watts
Output impedance:	8 Ω (4 and 16 Ω version also available)
Output for speaker cabinets:	2 x 6.3 mm jack sockets connected in parallel
Input from amplifier:	1 x 6.3 mm jack socket
Functions:	The LOAD BOX position mutes the connected speaker cabinet. The BYPASS/ATTENUATOR switch lets the user toggle quickly between full and reduced output.
Controls:	6-position switch, 5 increments (3 dB each) for volume reduction, equivalent to attenuation of the input power to 70%, 50%, 35%, 25%, 18%.

PALMER SPLITTERS & MERGERS



PCABM PASSIVE MERGER FOR GUITAR CABINETS

The concept behind the cab merger may be very simple, but it fills an important gap! Have you ever wanted to connect two guitar cabinets to one amplifier output? The PCABM makes it possible. In addition, you can select whether the cabinets should be wired in parallel or series with one another. For example, if you interconnect two 8 ohm cabinets. The PCABM offers you two resulting impedances to choose from: 4 ohms (parallel) or 16 ohms (serial). The device is passive and does not affect the tone in any way.

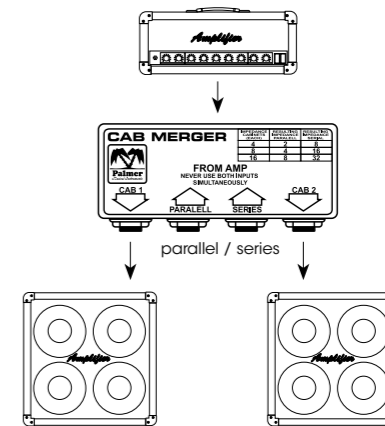

SPECIFICATIONS

Type:	passive
Inputs:	2 x 6.3 mm Jack
Outputs:	2 x 6.3 mm Jack
Dimensions (W x H x D):	105 x 35 x 35 mm



DACCAPO RE-AMPLIFICATION / IMPEDANCE MATCHER

Since the introduction of multitrack recording, sound shaping in the studio has been continuously refined. Re-amplification is one of today's recording techniques tracking the raw guitar signal usually in parallel with that from a guitar amplifier. The direct recording can now be fed to different amps to compare, mix, and match a variety of tones for the ultimate sound without the necessity of playing a part over and over again. Recording systems, however, provide different output levels than electric guitars which are designed for their own distinctive breed of amplifiers. This is where the Palmer DACCAPO re-amplification interface comes in, a dedicated tool to perfectly match recording system and guitar amplifier levels.

- Passive unit - does not require mains or batteries.
- High quality special design transformer that handles both the input levels of professional and semiprofessional recording systems.
- Selector switches between the professional +4dBu studio or -10dBV semiprofessional levels.
- Unbalanced hi-Z signal output modeled on that of an electric guitar
- Trim pot has been incorporated for precise level adjustment.
- Input and output electrically isolated.

SPECIFICATIONS

Inputs:	XLR female unbalanced, pin 1 = ground, pin 2 = in phase (hot), pin 3 = phase reversed (cold)
Input Impedance:	600 Ω nominally @ +4 dBu, 10 k Ω nominally @ -10 dBV
Input Level:	min. +22 dBu @ +4 dBu
Output:	1/4i (6.3 mm) TS jack, unbalanced
Output Impedance:	100 Ω nominally
Output Level:	max. 1:1 depending on the input level
THD:	< 0.02% @ nominal input level, typically 0.15% @ +20 dBu
Dimensions (W x H x D):	91 x 60 x 40 mm

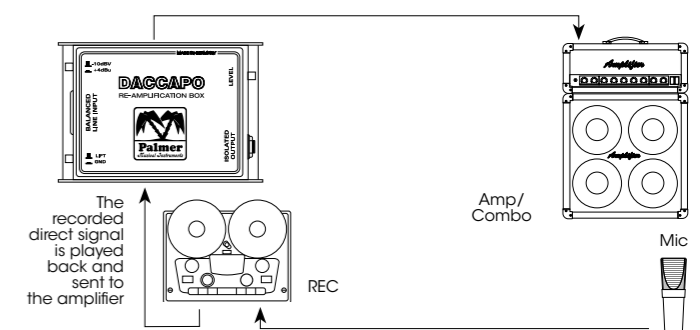

SPLITTERS
& MERGERS



DUETTO NANO MIXER & BUFFER AMP

The Palmer Duetto-Box is a small format mixer. The inputs are specifically configured for electric guitars in terms of level and impedance. The box of course also works well with normal line signals. The Duetto allows you to actively mix two sources together to one output, which can in turn be connected to an amplifier. Each input has a volume pot so that the levels can be adjusted. Especially guitar teachers who would like to play together with their student over one amp will value the Duetto. The Duetto's very low power consumption allows the unit to be powered by battery over many hours. However the box also offers a DC power socket where you can connect a standard 9V power adaptor.

Optional 9VDC Power Supply (Art. No.: PW9V) available

SPECIFICATIONS	
Inputs:	2 x unbalanced 6,3 mm jack / Input impedance: 1M Ohm / Max. Input Level: 1.55 V (+6dBu)
Output:	1x unbalanced 6,3mm jack
Output impedance:	10 kΩ
Amplification:	max x 2 (6dB)
Power Supply:	9V

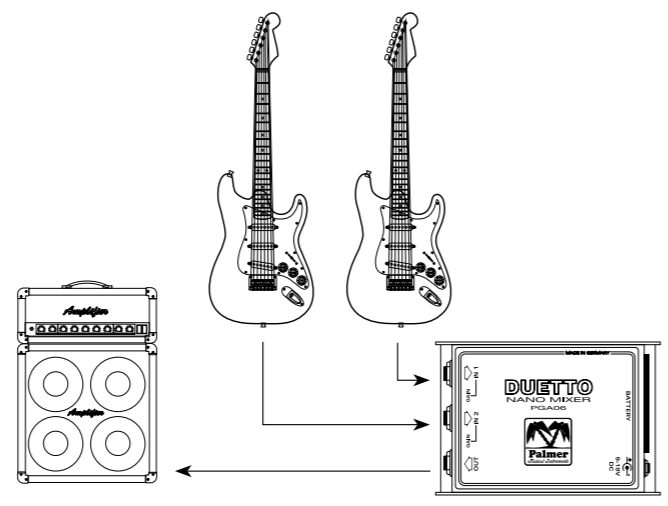

PGA 03 Y-BOX GUITAR SPLITTER

PGA 03 Y-Box, for splitting guitar signals. "I always get a loud hum when I hook up both my amps..." A rather common problem, we've got the answer! The Palmer Y-box's FET input circuitry adapts your guitar signal, driving a transformer which routes the ungrounded signal to the output. Ground hum is eliminated. 9V battery operation is recommended. The Y-Box also serves as a line driver for long leads, and it allows for phase reversal of the AMP 2 output. This comes in handy when you're using two (pre-)amps.

Optional 9VDC Power Supply (Art. No.: PW9V) available

SPECIFICATIONS	
Input impedance:	1 MΩ
Output:	Parallel AMP1 output, AMP2 output electronically buffered, and transformer isolated
Input and output sockets:	¼" Jack

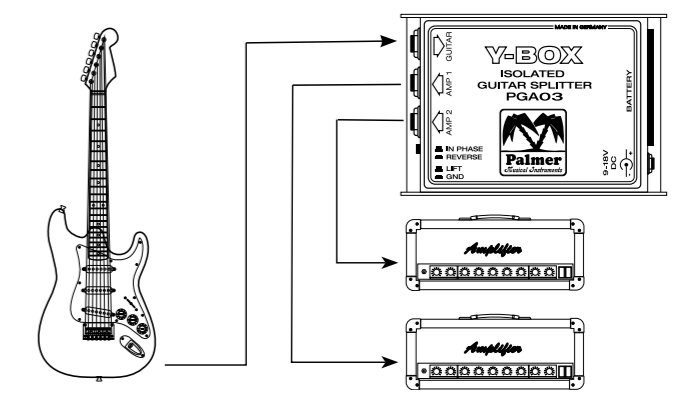

PALMER GUITAR AMPLIFIERS

GUITAR
AMPLIFIERS



DREI TRIPLE SINGLE-ENDED AMPLIFIER

The Palmer DREI design is more than just a visual extravaganza - it mirrors the concept and the circuitry. For the purest, most natural distortion only a single ended design will do. Single ended tube circuits are straightforward and simple providing the most organic, raw tube sounds possible. In contrast to the more powerful push-pull designs the output of single ended circuits usually does not exceed 5 Watts. That is why single ended circuits are mostly found in small practice amps preferred by many top-notch players for recording. A well-designed single ended circuit has many advantages.

- Extremely responsive
- Highly interactive and touch sensitive
- Purist design with a minimum of components
- Direct signal path
- Pure, natural distortion.

Dating back to the first days of vacuum tubes single ended amplifiers are nothing new. However, the Palmer DREI incorporates THREE of these providing three times the output power of a standard single ended design! Moreover, it accepts a variety of output tubes which all have their own unmistakable sound characteristics. The EL84 is bright and "British" sounding with tons of distortion (think VOX amps), the 6V6 provides somewhat darker tones with a smoother "American" distortion flavor (think Fender), and while it is tight and bright at lower volumes the 6L6 becomes progressively darker when driven hard. With the Palmer DREI you can mix and match power tubes for three distinct amplifier tones and to create your own voice. Three different single ended amps in a single unit - that's the Palmer DREI formula!

A LIST OF COMPATIBLE TUBES IS AVAILABLE ONLINE ON
WWW.PALMER-GERMANY.COM

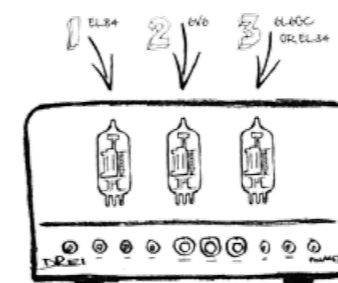

THREE DIFFERENT SINGLE-ENDED AMPS IN A SINGLE UNIT - THAT'S THE PALMER DREI FORMULA!

- Extremely responsive
- highly interactive and touch sensitive
- purist design with a minimum of components
- direct signal path
- 3 x Master Volumes
- pure, natural distortion



Palmer



EINS FULL TUBE GUITAR AMPLIFIER 1W

Small 1-5W amps have become very popular in recent years. They are fun items but some seem more like toys than real amplifiers. Palmers approach with the EINS was to design a serious true tube amplifier for professional purposes. The speaker simulated output allows you to connect the output of the amp directly to your audio interface. Thanks to the integrated loadbox a speaker does not need to be connected. Thanks to the unique "HiZ output" you can connect the output of the EINS directly to the input of any amplifier! This way the EINS can be power boosted or used as a preamp or even on your pedalboard.

The Palmer EINS comes with an ECC83 preamp tube (V1) and an ECC82 (V2) power stage tube as standard. Other tube configurations are possible as follows.

A LIST OF COMPATIBLE TUBES IS AVAILABLE ONLINE ON WWW.PALMER-GERMANY.COM

SPECIFICATIONS	
Technology / Class:	Tube / A
Power:	1 W
Inputs:	1 x 6.3 mm Jack
Input impedance:	1 MΩ
Outputs:	4 x 6.3 mm Jack
Output impedance:	Speaker out: 8 & 16 Ω, Simulated out: 4k, HiZ out: 3,3 MΩ
Display / Controls:	Power / Tone, level
Tubes:	ECC83 (Preamp), ECC82 (Power Amp)
Rectifier:	solid state
Power supply:	230 / 115 V AC
Power consumption:	10 W
Dimensions (W x H x D):	206 x 128 x 108 mm
Weight:	2.9 kg

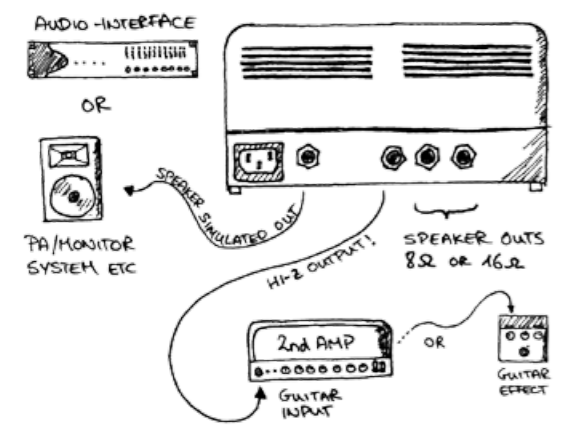

FAB 5 5 W ALL TUBE GUITAR COMBO

The Palmer FAB 5 combo is loaded with an extremely powerful 10" Ragin Cajun speaker by Eminence and has a maximum output of 5W. The design is an all-tube, single-ended circuit. The preamp tube is a time-tested 12AX7 (ECC83); the output stage uses a 6V6 tube in conjunction with an EZ81 tube rectifier. This makes the FAB 5 especially suitable for blues and rock sounds. The natural distortion and direct, lively response are typical for single-ended circuits. The amplifier is equipped with an internal power soak, which makes it possible to reduce the output by half or even to „bedroom level“ (5 W - Full, 2 W - Room, 0,05 W - Bedroom). Moreover, the amp also has an additional speaker output for connecting external speakers as well as a boost function that can be activated using an optionally available foot switch (when no foot switch is connected, the boost function is active and can be controlled using the corresponding boost knob).

SPECIFICATIONS	
Product type:	guitar amplifiers
Type:	combo
Technology:	tube
Class:	A
Power:	5 W
Input connectors:	1 x 6.3 mm Jack
Input impedance:	1 MΩ
Output connectors:	1 x 6.3 mm Jack
Output impedance:	8 Ω
Loudspeaker type:	Eminence Ragin Cajun
Loudspeaker diameter:	10" / 254 mm
Channels:	1
Display:	Power
Controls:	tone, volume, mains voltage selector, attenuator, Boost
FX loop:	no
Preamp tubes:	12AX7
Power amp tubes:	6V6
Rectifier:	Tube EZ81
Operating voltage:	230 / 115 V AC
Power consumption:	70 W
Cabinet material:	sheet steel, plywood
Dimensions (W x H x D):	360 x 345 x 230 mm
Weight:	10 kg





FAT 50 ALL TUBE GUITAR AMPLIFIER

Palmer FAT50 Tube Series amplifiers are for the guitarist in search of the distinct and highly individual sounds only a true all-tube design can produce. Full of character, yet straightforward and uncluttered Palmer amps are back - with tons of tone, high quality components, rugged construction and attractive cosmetics to fulfill the demands of discerning players.

The no-compromise FAT50 design incorporates a rainbow of sounds with punch and definition - from subtle crunch to maximum saturation, and a lively and dynamic clean tone with extended headroom. The FAT50's High Gain circuit provides massive overdrive for a comprehensive set list of quintessential riffs and classic lead lines. True to the no-compromise design there are no transistors in the signal path - even the effects loop is tube driven.

In addition to their outstanding sound quality Palmer amps offer unsurpassed reliability on stage and in the studio. Premium quality tubes are used throughout for safe and stable operation. With two footswitchable master volumes and a solid 50 Watts of true tube power FAT50 amps are built to be heard!

SPECIFICATIONS

Preamp Section

V1, V2:	ECC83/ 12AX7A highgrade
V3, V4:	ECC83/ 12AX7A selected

Power Amp Section

V5, V6:	5881 (6L6GC) matched set
Output Power:	50 W into 8 or 16 Ω

Speaker (only FAT50)	12" Eminence, Governor, 16 Ω
----------------------	-------------------------------------

General

Mains Voltage:	230 V~ +/-10%
Max. Power consumption:	150 W (42 W on Standby)
Dimensions (W x H x D):	580 x 500 x 270 mm
Weight:	28.4 kg



MACHT 402 19" SPECIALIZED STEREO POWER AMP FOR GUITAR

The Palmer MACHT 402 is a 19" stereo power amplifier specially designed for guitar applications. It pumps out 200 watts per channel and 400 watts bridged into 4 ohms to drive virtually all speaker cabinets. Featuring a highly efficient switch mode power supply and low noise fan the soft start class D design is protected against overvoltage, DC, short circuits and overheating.

Conventionally named, the channels' Hi and Low controls have been carefully tailored for guitar signals to provide extensive EQ facility, a wide variety of sounds and authentic tube power stage characteristics. In addition, the MACHT 402 sports rumble filtering, LED indicators, a 3-way sensitivity selector, built-in limiter and ground lift switch. With XLR and 6.35 mm inputs as well as Speakon compatible and 6.35 mm output connectors the Palmer MACHT 402 is the ideal power station for guitar preamps, small amps, modelers and even effects pedals.

SPECIFICATIONS

Product type:	2-channel power amplifier
Rated output power (1kHz (at) 4 Ω):	2 x 200 W
Rated output power (1kHz (at) 8 Ω):	2 x 100 W
Rated output power (1kHz (at) 8 Ω , bridged):	400 W
Output circuitry:	Class D
Frequency response:	20 - 20000 Hz
THD:	< 0.1 %
Gain:	32 dB / 26 dB / 28 dB
Input sensitivity:	0,68 V / 1,4 V / 1,2 V
Protection circuits:	DC, short circuit, soft start, thermal overload, over-current
Controls:	volume, Sensitivity, On / Off, mode, limiter, low, high, ground lift
Indicators:	signal, Power, protect (protection circuit engaged), clip, mode
Line inputs:	2
Line input connectors:	RCA, 6.3 mm Jack
Loudspeaker outputs:	2
Speaker output connections:	Speakon compatible, 6.3 mm Jack
Cooling:	low-noise fan
Operating voltage:	Switching Power Supply
Power consumption (at) full load:	470 W
Operating voltage:	115 V AC / 230 V AC (switchable)
Dimensions (W x H x D):	482 x 44 x 244 mm
Weight:	3.8 kg

FEATURES

- 200 watts per channel into 4 ohms
- 400 watts bridged for mono use
- Carefully tailored, guitar specific EQ
- Input sensitivity selector for use with preamps, pedals etc.
- Built-in limiter
- All major protections
- Works with virtually any cabinet(s)

PALMER CUSTOM CABINETS



GUITAR
CABINETS

Custom Made
Cabinets

FIND & ORDER
YOUR INDIVIDUAL CABINET!

WWW.PALMER-GERMANY.COM
PALMER IS A BRAND OF THE ADAM HALL GROUP



Jackplate Info
Two In/Out jack sockets
wired in parallel

PCAB 112 1 X 12" GUITAR CABINET

For a tightly focused sound with extended lows, punchy mids and sweet highs the 12" speaker has been the first choice in live and recording applications for decades. Most combo amps got away with just one of those to deliver legendary guitar tones.

With the Eminence FDM speaker options loudspeaker level and tone response are at your fingertips by simply turning the magnet flux control at the back of the speaker to suit your taste. With a built-in attenuator Eminence FDM speakers are available in American and British flavors for precision tone shaping. Get in touch to find out more!

SPECIFICATIONS

Dimensions (W x H x D):	58 x 45 x 29 cm
Front Grill:	Fabric, detachable
Speaker mounting:	1 x 12" Front mounted
Cabinet rear:	open back
Weight without speaker:	12 kg



Article No	Speaker	Cabinet Impedance (Mono)	Power Rating (Mono)	Cabinet weight
PCAB112GOV	GOVERNOR 8 Ω	8 Ω	75 W	16 kg
PCAB112LEG	LEGEND 1258 8 Ω	8 Ω	75 W	16 kg
PCAB112MAV	FDM* MAVERICK 8 Ω	8 Ω	75 W	16 kg
PCAB112MOW	MAN O WAR 8 Ω	8 Ω	120 W	17 kg
PCAB112PJA	PRIVATE JACK 8 Ω	8 Ω	50 W	17 kg
PCAB112REX	CANNABIS REX 8 Ω	8 Ω	50 W	17 kg
PCAB112RGN	FDM* REIGNMAKER 8 Ω	8 Ω	75 W	16 kg
PCAB112RWB	RED, WHITE & BLUES 8 Ω	8 Ω	120 W	17 kg
PCAB112TXH	TEXAS HEAT 8 Ω	8 Ω	150 W	17 kg
PCAB112V30	VINTAGE 30 8 Ω	8 Ω	60 W	16 kg
PCAB112WIZ	WIZARD 8 Ω	8 Ω	75 W	17 kg
PCAB112GBK	CELESTION GREENBACK 8 Ω	8 Ω	25 W	16 kg
PCAB112S80	CELESTION SEVENTY 80 8 Ω	8 Ω	75 W	16 kg

* FDM:
FLUX DENSITY MODULATION
ATTENUATION DIAL ON THE REAR OF THE SPEAKER





PCAB 212 2 X 12" GUITAR CABINET

For a tightly focused sound with extended lows, punchy mids and sweet highs the 12" speaker has been the first choice in live and recording applications for decades. Most combo amps got away with just one of those to deliver legendary guitar tones.

With the Eminence FDM speaker options loudspeaker level and tone response are at your fingertips by simply turning the magnet flux control at the back of the speaker to suit your taste. With a built-in attenuator Eminence FDM speakers are available in American and British flavors for precision tone shaping. Get in touch to find out more!

SPECIFICATIONS

Dimensions (W x H x D):	71 x 48 x 29.5 cm
Front Grill:	Fabric, detachable
Speaker mounting:	2 x 12" Front mounted
Cabinet rear:	closed back (open back version also available)
Weight without speakers:	15.6 kg



Article No	Speaker	Cabinet Impedance (Mono)	Cabinet Impedance (Stereo)	Power Rating (Mono)	Power Rating (Stereo)	Cabinet weight
PCAB212GOV	GOVERNOR 16 Ω	8 Ω	16/Speaker	150 W	75 W/Speaker	27 kg
PCAB212LEG	LEGEND 1258 8 Ω	4 Ω	8/Speaker	150 W	75 W/Speaker	23 kg
PCAB212MOW	MAN O WAR 16 Ω	8 Ω	16/Speaker	240 W	120 W/Speaker	25 kg
PCAB212PJA	PRIVATE JACK 16 Ω	8 Ω	16/Speaker	100 W	50 W/Speaker	26 kg
PCAB212REX	CANNABIS REX 16 Ω	8 Ω	16/Speaker	100 W	50 W/Speaker	25 kg
PCAB212RWB	RED, WHITE & BLUES 8 Ω	4 Ω	8/Speaker	240 W	120 W/Speaker	25 kg
PCAB212TXH	TEXAS HEAT 16 Ω	8 Ω	16/Speaker	300 W	150 W/Speaker	25 kg
PCAB212V30	VINTAGE 30 16 Ω	8 Ω	16/Speaker	120 W	60 W/Speaker	24 kg
PCAB212WIZ	WIZARD 16 Ω	8 Ω	16/Speaker	150 W	75 W/Speaker	26 kg
PCAB212GBK	CELESTION GREENBACK 16 Ω	8 Ω	16/Speaker	50 W	25 W/Speaker	24 kg
PCAB212S80	CELESTION SEVENTY 80 16 Ω	8 Ω	16/Speaker	160 W	80 W/Speaker	26 kg

>> Add „OB“ to the end of the article number to order an open back version

EMINENCE[®]

EMINECE SPEAKERS

From dialing a sound in, to rocking it out, for over 45 years Eminence has been the leading choice in audio applications worldwide.



THE GOVERNOR™

Tight low-end, smooth midrange, top end sparkle



LEGEND 1258

Tight lows, warm smooth mids and highs, strong upper mid emphasis, extended highs



CANNABIS REX™

Clean and full, lots of body and sparkle., smokey smooth with high-end definition, Country, Jazz or Classical

SPECIFICATIONS	THE GOVERNOR™	LEGEND 1258	MAN O WAR	CANNABIS REX™
Nominal Basket Diameter	12", 304.8 mm	12", 304.8 mm	12", 304.8 mm	12", 304.8 mm
Nominal Impedance	8 or 16 Ω	8 Ω	8 or 16 Ω	8 or 16 Ω
Power Rating	75 W	75 W	120 W	50 W
Resonance	101 Hz	94 Hz	91 Hz	96 Hz
Usable Frequency Range	70 Hz - 5 kHz	80 Hz - 4 kHz	70 Hz - 5.5 kHz	70 Hz - 5 kHz
Sensitivity	102 dB	100.1 dB	102 dB	102 dB
Magnet Weight	56 oz.	34 oz.	38 oz.	38 oz.
Voice Coil Diameter	1.75", 44.5 mm	1.5", 38.1 mm	1.75", 44.5 mm	1.75", 44.5 mm
Net Weight	10.8 lbs., 4.9 kg	7.8 lbs., 3.5 kg	8.1 lbs., 3.7 kg	8.2 lbs., 3.7 kg

MATERIALS OF CONSTRUCTION

	THE GOVERNOR™	LEGEND 1258	MAN O WAR	CANNABIS REX™
Coil Construction	Copper	Copper	Copper	Copper
Magnet Composition	Ferrite magnet	Ferrite magnet	Ferrite magnet	Ferrite magnet
Basket Materials	Pressed steel	Pressed steel	Pressed steel	Pressed steel



RED, WHITE & BLUES™

Versatile, great for southern rock or blues, nice tight low-end, smooth midrange and top end sparkle.



TEXAS HEAT™

Warm, fat tone with top end bite and clarity to cut through a mix while maintaining a rich, bluesy tone, very touch-sensitive



CV75

Complete tonal balance. Grunt and punch in the lows, warm/tailored mids, and nice, clear, open/airy highs.



PRIVATE JACK™

Well balanced, thick and smooth, lots of mids and extended highs.



THE WIZARD™

Very articulate, with a hint of grit, nice sustain, exceptionally good tight bottom, classic rock tones of the 60s and 70s



MAN O WAR

Very loud and responsive/articulate in every register, chunky and solid sound with a little top end sparkle

SPECIFICATIONS	PRIVATE JACK™	RED, WHITE & BLUES™	TEXAS HEAT™	THE WIZARD™	CV75
Nominal Basket Diameter	12", 304.8 mm	12", 304.8 mm	12", 304.8mm	12", 304.8 mm	12", 304.8 mm
Nominal Impedance	8 or 16 Ω	8 Ω	8, 4 or 16 Ω	8 or 16 Ω	8 Ω
Power Rating	50 W	120 W	150 W	75 W	75 W
Resonance	96 Hz	110 Hz	79 Hz	89 Hz	79 Hz
Usable Frequency Range	70 Hz - 5 kHz	70 Hz - 4.5 kHz	70 Hz - 5 kHz	70 Hz - 5.5 kHz	80 Hz - 5.5 kHz
Sensitivity	101 dB	101 dB	99 dB	103 dB	102 dB
Magnet Weight	38 oz.	38 oz.	38 oz.	56 oz.	56 oz.
Voice Coil Diameter	1.75", 44.5 mm	1.75", 44.5 mm	2", 50.8 mm	1.75", 44.5 mm	1.75", 44.5 mm
Net Weight	8 lbs., 3.6 kg	8.2 lbs., 3.7 kg	8.3 lbs., 3.8 kg	10.8 lbs., 4.9 kg	10.8 lbs., 4.9 kg

MATERIALS OF CONSTRUCTION

	PRIVATE JACK™	RED, WHITE & BLUES™	TEXAS HEAT™	THE WIZARD™	CV75
Coil Construction	Copper	Copper	Copper	Copper	Copper
Magnet Composition	Ferrite magnet	Ferrite magnet	Ferrite magnet	Ferrite magnet	Ferrite magnet
Basket Materials	Pressed steel	Pressed steel	Pressed steel	Pressed steel	Pressed steel

EMINENCE[®]

EMINECE SPEAKERS WITH FDM TECHNOLOGY

The patented new FDM™ technology lets you adjust your tone directly at the Eminence Maverick™ or Reignmaker™ speaker. Just turn the modulator knob to adjust speaker output and amplifier interaction. That lets you achieve saturated tube tone at a lower volume. Tweak the knob for a wide range of tones. More attenuation affords a warmer tone, while less attenuation provides more punch and brightness. Give it a try.



MAVERICK™

Clean with fat low end

REIGNMAKER™

Tight, more focused with more highs, more abundant in harmonic detail

SPECIFICATIONS	MAVERICK™	REIGNMAKER™
Nominal Basket Diameter	12", 304.8 mm	12", 304.8 mm
Nominal Impedance	8 Ω	8 Ω
Power Rating	75 W	75 W
Resonance	82.45 Hz	91.0 Hz
Usable Frequency Range	75 Hz - 5.2 kHz	80 Hz - 6.2 kHz
Sensitivity	Max. Attenuation 91.5 dB / Full Output: 100 dB	Max. Attenuation 91.5 dB / Full Output: 100 dB
Magnet Weight	38 oz.	38 oz.
Voice Coil Diameter	1.75", 44.5 mm	1.75", 44.5 mm
Net Weight	7.8 lbs., 3.54 kg	7.8 lbs., 3.54 kg

MATERIALS OF CONSTRUCTION

Coil Construction	Copper	Copper
Magnet Composition	Ferrite magnet	Ferrite magnet
Basket Materials	Pressed steel	Pressed steel

CELESTION

CELESTION SPEAKERS

Responsible for the first ever dedicated guitar speaker, Celestion drivers have become the 'voice of rock & roll', delivering many of the most memorable performances by guitarists including Jimi Hendrix and Slash through to the current crop of high-octane shredders.



VINTAGE 30

Detailed and complex overtones, warm low-end, rich vocal mid-range and a beautifully detailed top-end.



CREAMBACK

Tight low end, more dynamic high end.



GREENBACK

Well-controlled low-end, broad mid-range attack, restrained top-end, forward punchy attitude to chords, searing lead tones without fizz.



G12H

With a strong, aggressive low-end and powerful low-mids

SPECIFICATIONS	VINTAGE 30	GEENBACK	CREAMBACK	G12H
Nominal Basket Diameter	12", 304.8 mm	12", 304.8 mm	12", 304.8mm	12", 304.8mm
Nominal Impedance	16 Ω	8 Ω	8 Ω	8 Ω
Power Rating	60 W	25 W	75 W	30 W
Resonance	75 Hz	75 Hz	75 Hz	85 Hz
Usable Frequency Range	70 Hz - 5 kHz	75 Hz - 4.5 kHz	70 Hz - 5 kHz	75 Hz - 5 kHz
Sensitivity	100 dB	98 dB	100 dB	100 dB
Magnet Weight	50 oz.	35 oz.	50 oz.	50 oz.
Voice Coil Diameter	1.75", 44.5 mm	1.75", 44.5 mm	1.75", 44.5 mm	1.75", 44.5 mm
Net Weight	10.4 lbs., 4.7 kg	7.9 lbs., 3.6 kg	10.4 lbs., 4.7 kg	10.4 lbs., 4.7 kg

MATERIALS OF CONSTRUCTION

Coil Construction	Copper	Copper	Copper	Copper
Magnet Composition	Ceramic	Ceramic	Ceramic	Ceramic
Basket Materials	Pressed steel	Pressed steel	Pressed steel	Pressed steel



Gravity[®]
stand your ground.

DISCOVER OUR
INNOVATIVE PREMIUM STANDS

available colours:



MILLIONS SAW THE APPLE FALL,
ISAAC NEWTON ASKED "WHY"?

MILLIONS SAW STANDS BREAK,
WE ASKED "WHY"?



CATEGORY
MICROPHONE
STANDS

DESIGNED & ENGINEERED
IN GERMANY.



www.facebook.com/gravitystands
www.youtube.com/gravitystands
blog.adamhall.com

find out more:
www.gravitystands.com
Gravity[®] is a brand of the Adam Hall Group.



Palmer
audio tools

