

ALLEN & HEATH

QU-24

QU-16



QU-32

Qu SERIES DIGITAL MIXERS User Guide



For firmware V1.6
Check www.allen-heath.com for the latest firmware available

Publication AP9372

Limited One Year Manufacturer's Warranty

Allen & Heath warrants the Allen & Heath -branded hardware product and accessories contained in the original packaging ("Allen & Heath Product") against defects in materials and workmanship when used in accordance with Allen & Heath's user manuals, technical specifications and other Allen & Heath product published guidelines for a period of ONE (1) YEAR from the date of original purchase by the end-user purchaser ("Warranty Period").

This warranty does not apply to any non-Allen & Heath branded hardware products or any software, even if packaged or sold with Allen & Heath hardware.

Please refer to the licensing agreement accompanying the software for details of your rights with respect to the use of software/firmware ("EULA").

Details of the EULA, warranty policy and other useful information can be found on the Allen & Heath website: www.allen-heath.com/legal.

Repair or replacement under the terms of the warranty does not provide right to extension or renewal of the warranty period. Repair or direct replacement of the product under the terms of this warranty may be fulfilled with functionally equivalent service exchange units.

This warranty is not transferable. This warranty will be the purchaser's sole and exclusive remedy and neither Allen & Heath nor its approved service centres shall be liable for any incidental or consequential damages or breach of any express or implied warranty of this product.

Conditions Of Warranty

The equipment has not been subject to misuse either intended or accidental, neglect, or alteration other than as described in the User Guide or Service Manual, or approved by Allen & Heath.

Any necessary adjustment, alteration or repair has been carried out by an authorised Allen & Heath distributor or agent.

The defective unit is to be returned carriage prepaid to the place of purchase, an authorised Allen & Heath distributor or agent with proof of purchase. Please discuss this with the distributor or the agent before shipping. If the unit is to be repaired in a different country to that of its purchase the repair may take longer than normal, whilst the warranty is confirmed and parts are sourced. Units returned should be packed in the original carton to avoid transit damage.

DISCLAIMER: Allen & Heath shall not be liable for the loss of any saved/stored data in products that are either repaired or replaced.

Check with your Allen & Heath distributor or agent for any additional warranty information which may apply. If further assistance is required please contact Allen & Heath Ltd.



Qu Series products comply with the European Electromagnetic Compatibility directive 2004/108/EC and the European Low Voltage directive 2006/95/EC.

Any changes or modifications to the product not approved by Allen & Heath could void the compliance of the product and therefore the users authority to operate it.

Qu Mixer User Guide AP9372 Issue 5

Copyright © 2014 Allen & Heath. All rights reserved

ALLEN & HEATH

Allen & Heath Limited, Kernick Industrial Estate, Penryn, Cornwall, TR10 9LU, UK

<http://www.allen-heath.com>

IMPORTANT - Read these instructions before starting:

Safety instructions

Before starting, read the **Important Safety Instructions** printed on the sheets supplied with the equipment. For your own safety and that of the operator, technical crew and performers, follow all instructions and heed all warnings printed on the sheet and on the equipment panels.

System operating firmware

The function of the Qu mixer is determined by the firmware (operating software) that runs it. Firmware is updated regularly as new features are added and improvements made. The firmware version current when this guide was released is noted in the Contents section.

The latest firmware can be downloaded from the Allen & Heath website, transferred to USB key and then loaded into the Qu mixer using the Firmware Update utility.

- **Check the Allen & Heath website for the latest version of Qu firmware.**

Software licence agreement

By using this Allen & Heath product and the software within it you agree to be bound by the terms of the relevant **End User Licence Agreement** (EULA), a copy of which can be found on the Allen & Heath website (www.allen-heath.com/legal). You agree to be bound by the terms of the EULA by installing, copying, or using the software.

Further information



Please refer to the **Allen & Heath website** for further information, knowledgebase and technical support. You can join our Allen & Heath Digital Community to share knowledge and information with other Qu users.

General precautions

- To prevent damage to the controls and cosmetics, avoid placing heavy objects on the control surface, obstructing movement of the motorised faders, scratching the surface or touch screen with sharp objects, or rough handling and vibration.
- Protect the equipment from damage through liquid or dust contamination. Avoid dust or small objects getting into the fader slots. Cover the mixer when it is not being used for a long period.
- Computer and touch screen technology can be affected by extreme cold. If the equipment has been stored in sub-zero temperatures allow time for it to reach normal operating temperature before use at the venue. Recommended operating temperature for Qu is 5 to 35 degrees Celsius.
- Avoid using the equipment in extreme heat and direct sunlight. Make sure the mixer ventilation slots are not obstructed and that there is adequate air movement around the equipment.
- Transport the Qu using a touring grade, purpose designed flightcase with adequate foam lining and internal support for protection.
- Clean the control surface with a soft brush and dry lint-free cloth. Do not use chemicals, abrasives or solvents.
- It is recommended that servicing is carried out only by an authorised Allen & Heath agent. Contact details for your local distributor can be found on the Allen & Heath website. Allen & Heath do not accept liability for damage caused by maintenance, repair or modification by unauthorised personnel.

1. Packed contents

Qu Mixer

Mains lead • Check this is correct for your territory



User Guide AP9372



Safety Sheets

AP3345 – English
AP7287 – French
AP8513 – Chinese

• Read this before starting

Options and Accessories available

Remote Audio Racks
Provides remote audio over dSNAKE Cat5 cable digital snake.

AR2412 24 Mic/Line in, 12 Line out
Part: GLD-AR2412



AR84 8 Mic/Line in, 4 Line out
Part: GLD-AR0804



AB168 16 Mic/Line in, 8 Line out Remote AudioRack.
Part: AB1608



LEDlamp
Right angled 4-pin XLR LED lamp with built-in dimmer
Part: LEDlampX



19" Rack Ear Kit for Qu-16
To mount the Qu-16 in a standard 19" rack or flightcase. These fit over the plastic trims.
Part: QU-16-RK19

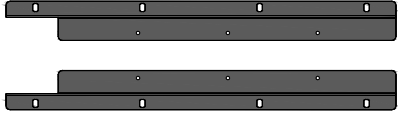

Soft cover



Qu	AP9262 Qu-16
	AP9458 Qu-24
	AP9639 Qu-32

Cat5 cables
For use with dSNAKE remote audio

- AH8822 2m (6.6') short patch
- AH9651 20m (66') coil
- AH9650 100m (330') drum



Qu-Pad app for iPad
Qu-You app for iOS devices
Available from the Apple Store

Full mix control Personal monitoring

REGISTER YOUR PRODUCT online at: www.allen-heath.com/register

Qu Mixer User Guide

4

AP9372 iss.5

2. Contents

1.	Packed contents	4
2.	Contents	5
3.	Introduction	7
3.1	Overview and Features	7
3.2	System Architecture and Processing	8
3.3	Differences between the Qu models	9
4.	Connection Overview	11
4.1	Local Input Connections	11
4.2	Local Output Connections	12
4.3	Other Connections	12
4.4	Powering up the mixer	13
5.	Connecting dSNAKE Remote Audio	14
5.1	Connecting to a remote AudioRack	14
5.2	Qu Systems	16
5.3	The ME Personal Mixing System	18
6.	Operational Overview	19
6.1	Fader Strips	19
6.2	Channel Naming	21
6.3	Channel Processing	22
6.4	Working with the Processing:	22
6.5	Working with Processing Libraries:	22
6.6	Processing Libraries	27
6.7	List of Factory Libraries	28
6.8	Channel Routing	29
6.9	Working with the Routing screens	29
6.10	Working with the Groups (not Qu-16)	30
6.11	Working with the Matrix (not Qu-16)	31
6.12	Mute and DCA Groups	32
6.13	Using Mute Groups	33
6.14	Using DCA Groups	34
6.15	The Master Strip	35
6.16	Working with the sends on faders:	36
7.	Touch Screen Mixing Functions	37
7.1	Copy, Paste, Reset keys	38
7.2	The Sel screens – Processing and Routing	39
7.3	Home Screen	39
7.4	Home Screen – User	40
7.5	Home Screen – Meters	41
7.6	Home Screen – RTA	41
7.7	Home Screen – Qu-Drive (USB audio)	41
7.8	The FX	44
7.9	Working with FX – Adding vocal reverb:	46
7.10	Scene Memories	47
8.	Touch Screen Setup Functions	50
8.1	Audio Setup -PAFL	50
8.2	Audio Setup - Talkback	51
8.3	Audio Setup –Signal Generator	51

8.4	Control Setup – Custom Layer	52
8.5	Control Setup - SoftKeys	53
8.6	Control Setup - Network	54
8.7	Control Setup - MIDI	54
8.8	USB Data – Scene Transfer	55
8.9	USB Data – Library transfer	55
8.10	USB Data – Show transfer	56
8.11	Output Patch Setup – Surface	57
8.12	Output Patch Setup – dSNAKE	57
8.13	Output Patch Setup - Monitor	58
8.14	Output Patch Setup – USB Audio.....	59
8.15	Utility - Calibration	60
8.16	Utility – Qu-Drive	60
8.17	Utility – Firmware Update.....	61
9.	Working with Audio Streaming and a DAW.....	62
10.	iOS Apps for Wireless Control.....	64
11.	Resetting the Mixer	67
11.1	Reset Mix Settings – A starting point for mixing.....	67
11.2	System Hard Reset	68
12.	Specifications.....	69
12.1	Mechanical Details.....	69
12.2	Qu-16 System Block Diagram	70
12.3	Qu-24 and Qu-32 System Block Diagram.....	71
12.4	System Specifications.....	72

About this guide

This is the User Guide for the Allen & Heath Qu-16, Qu-24 and Qu-32 digital mixers.

Please Note

This guide refers to Qu firmware **V1.6**. Please refer to the Allen & Heath website for the latest version of firmware and this user guide. For more details read the Release Notes available with the firmware.

For information on the **AR2412**, **AR84** and **AB168** remote AudioRacks please refer to their user guides.

3. Introduction

3.1 Overview and Features

Building on the heritage of the GLD and flagship iLive digital consoles, the Qu presents exceptional performance together with an intuitive analogue style user interface with a motorised fader per channel, knobs and touch screen, total recall of all settings, full input, output and FX processing, USB streaming and hard drive multitrack recording, digital snake capability and remote wireless control using an iPad. There are three models in the Qu Digital Audio Mixer Series:

Qu-16 – Compact, rack mountable mixer with 16 mic and 3 stereo line input channels.

Qu-24 – Larger model with 24 mic and 3 stereo inputs. Adds stereo Groups, Matrix and more SoftKeys.

Qu-32 – Largest model with 32 mic and 3 stereo inputs. Adds 2 more stereo Groups.

Qu-16	Qu-24	Qu-32
<ul style="list-style-type: none">• 16 Mic/Line channels• 3 stereo Line channels• 24 sources to the mix• 12 mixes (4 mono, 3 stereo, LR)• 4 FX (2 send buses)• 4 SoftKeys• 24 out, 22 in USB streaming	<ul style="list-style-type: none">• 24 Mic/Line channels• 3 stereo Line channels• 32 sources to the mix• 12 mixes (4m, 3st, LR)• 4 FX (4 send buses)• 10 SoftKeys• 32 out, 30 in USB• 2 stereo Groups• 2 stereo Matrix	<ul style="list-style-type: none">• 32 Mic/Line channels• 3 stereo Line channels• 40 sources to the mix• 12 mixes (4m, 3st, LR)• 4 FX (4 send buses)• 10 SoftKeys• 32 out, 32 in USB• 4 stereo Groups• 2 stereo Matrix

All models



- Extra stereo outputs – AES digital, Alt Out, 2TRK out
- Talkback mic input
- dSNAKE Cat5 snake for remote audio using AR2412, AR84 or AB168
- 4 Mute Groups
- 4 DCA Groups
- AnaLOGIQ™ total recall analogue preamps
- Effects ported from the flagship iLive console
- Dedicated stereo FX return channels
- Master strip for quick access to mix levels and processing
- Input channel linking for stereo sources
- Input processing – Preamp, HPF, Gate, PEQ, Compressor, Delay
- Output processing – PEQ, Graphic EQ, Compressor, Delay
- 800x480 pixel colour touch screen for quick control
- Motorised faders for sends on faders, GEQ fader flip and mix recall
- Quick copy and reset of processing, mixes and scenes
- 100 Scene memories
- Channel Safes, Global and per Scene Recall Filters
- FX, processing and channel User Libraries
- Qu-Drive for stereo and 18-track recording/playback to USB hard drive
- USB streaming to/from an Apple® Mac or Windows™ PC computer
- MIDI DAW Control driver for Mac (converts to HUI or Mackie Control)
- USB transfer of Scenes, Libraries, Shows
- User assignable Custom Layer
- Qu-Pad engineer's mixing wireless remote app for iPad
- Qu-You personal monitoring app for iPhone, iPad, iPod Touch
- Compatible with the Allen & Heath ME personal mixing system
- User Permissions to restrict operator access

3.2 System Architecture and Processing

The following diagrams show the Qu-16, Qu-24 and Qu-32 I/O (inputs and outputs), audio architecture and processing available. The differences between the models and the routing capability of each processing section is illustrated. Refer also to the more detailed System Block Diagrams at the rear of this guide.

Qu-16 SIGNAL FLOW

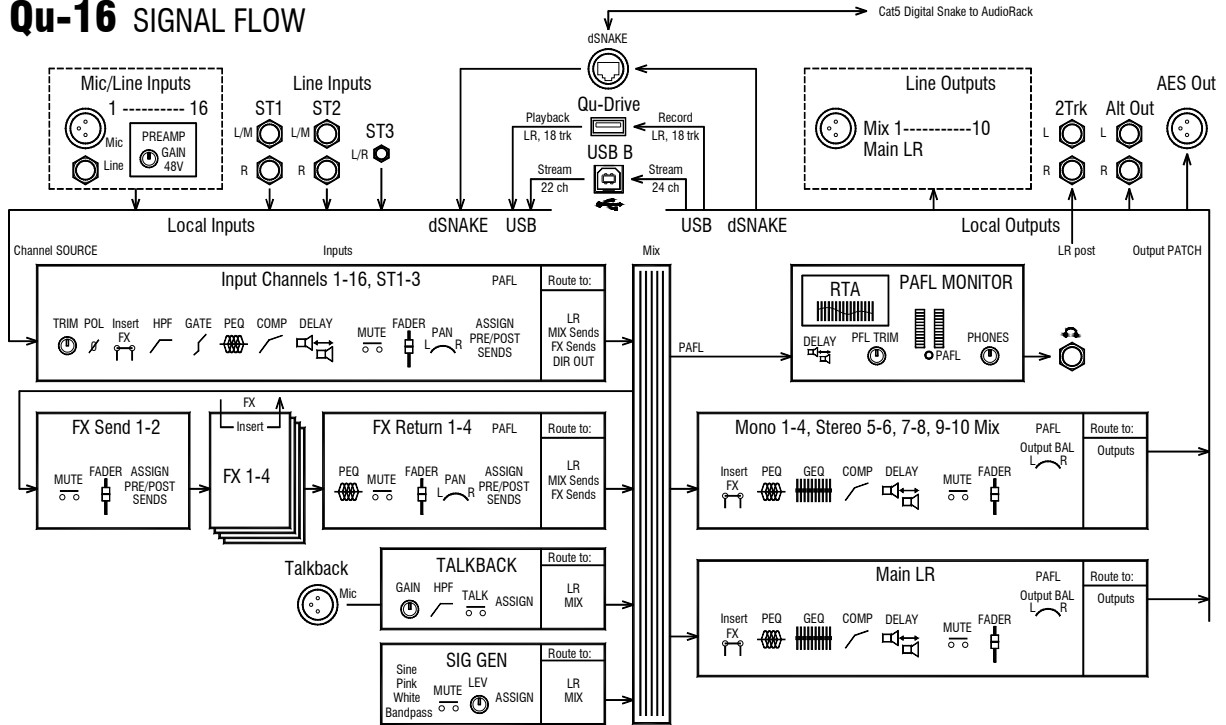

Qu-24(32) SIGNAL FLOW

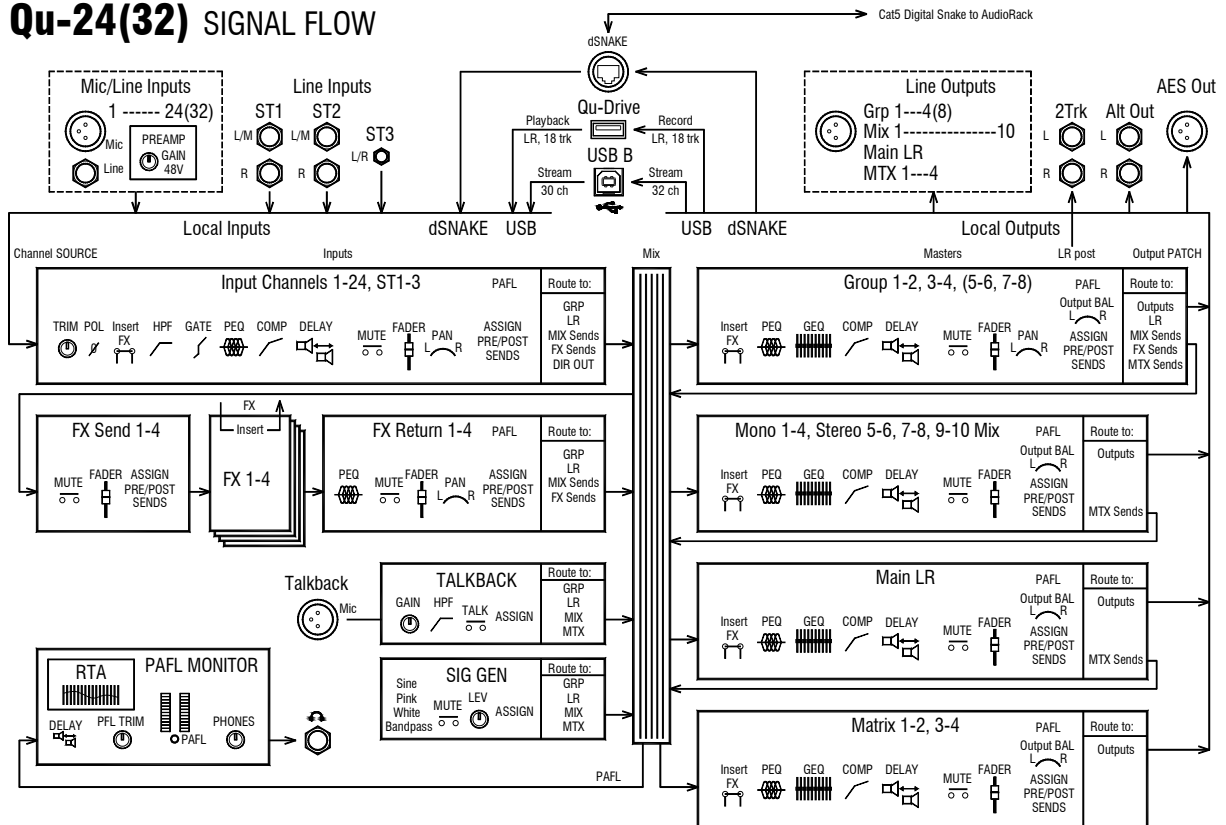

3.3 Differences between the Qu models

All three models operate in the same way and have a similar touch screen menu structure. The larger models add Groups and Matrix. Other differences are shown here:

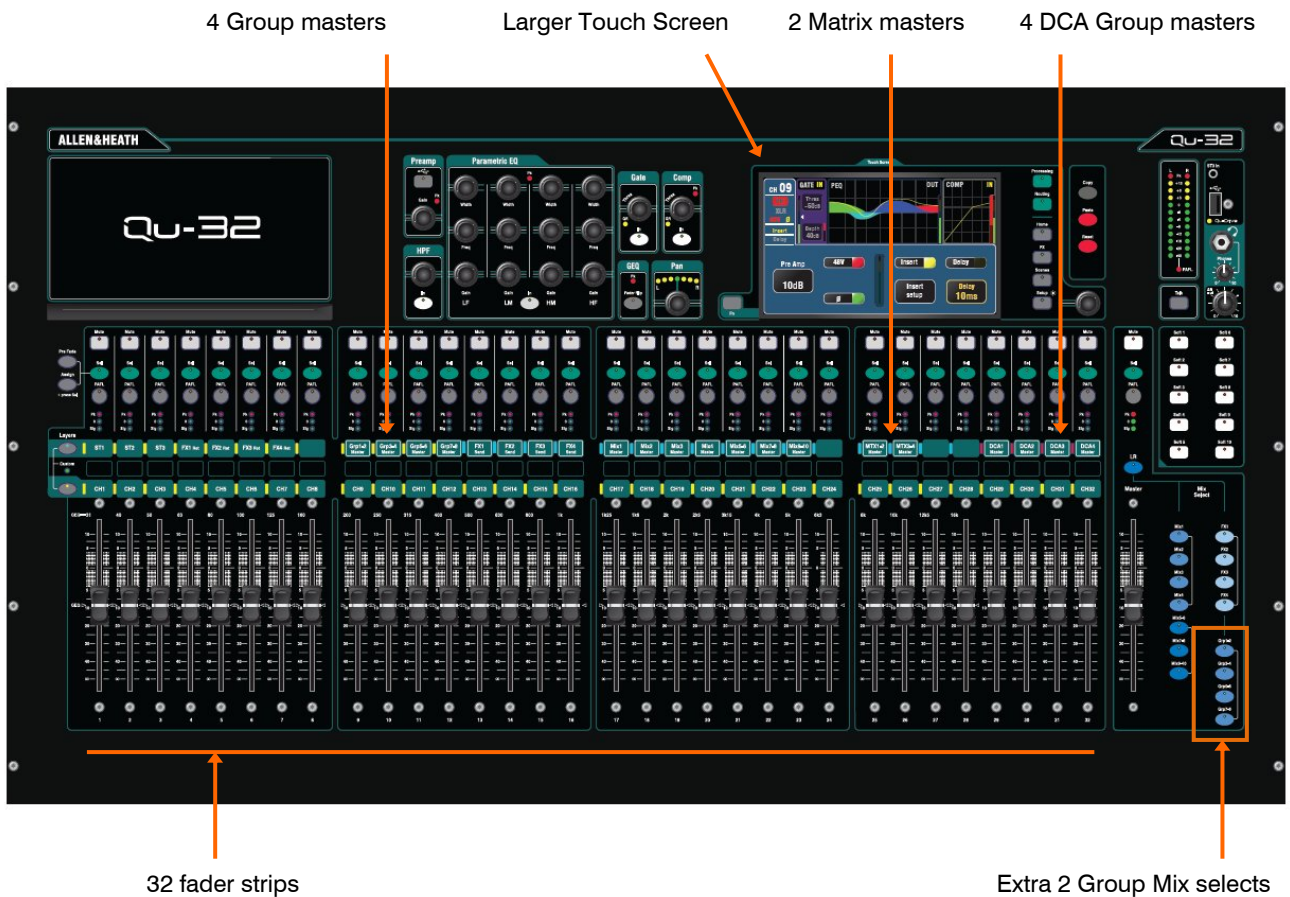
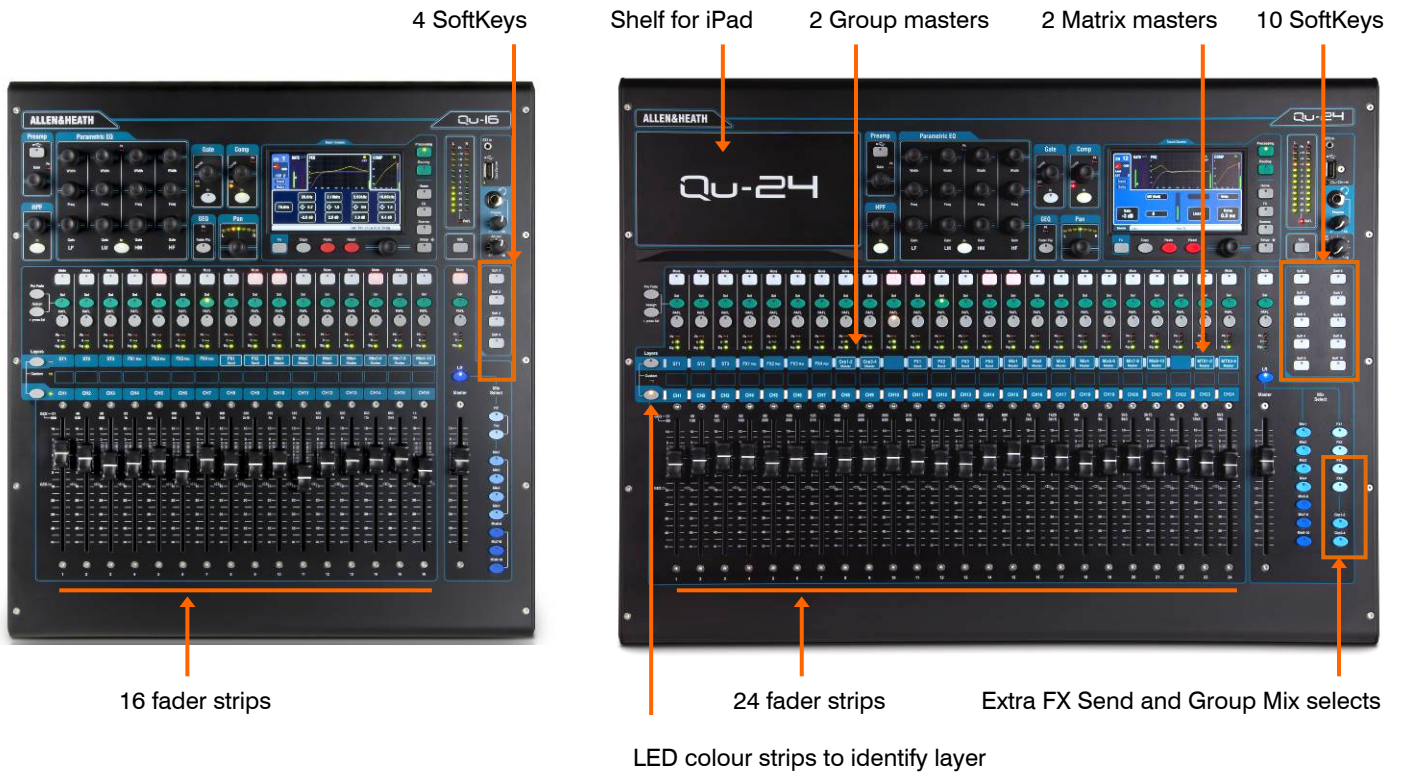

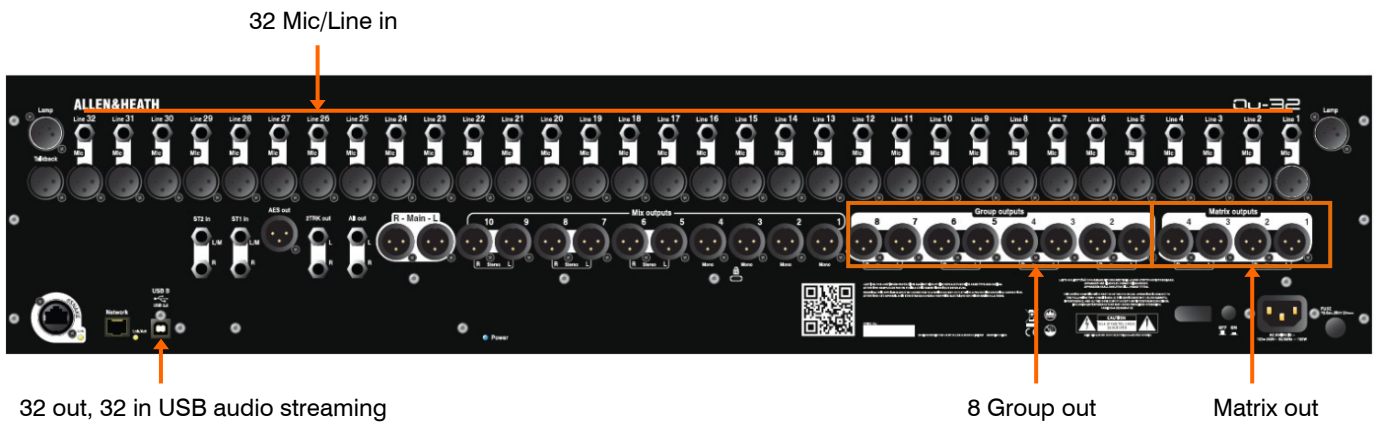
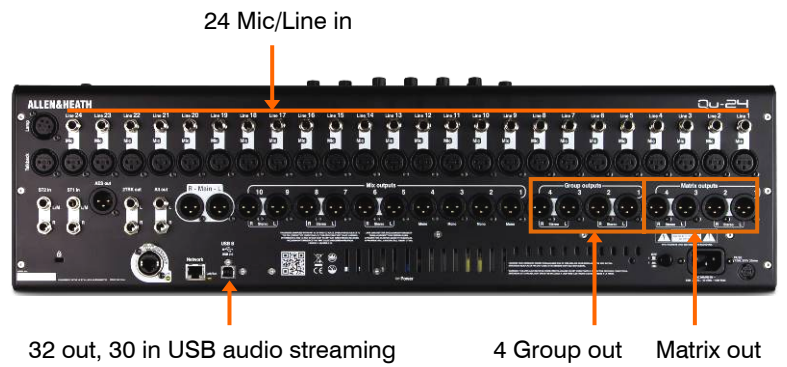
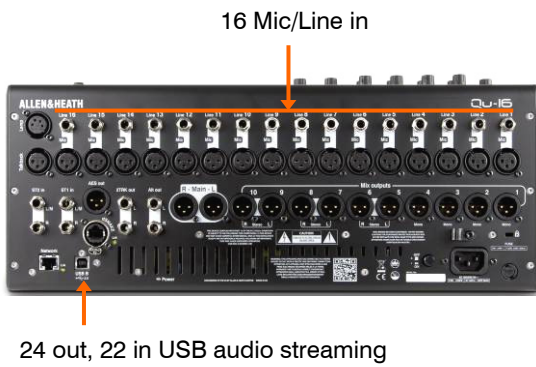

Scene, Library and Show memories - Qu-16, Qu-24 and Qu-32 memories are compatible. Files created on one model can be transferred via USB key and loaded on the other. The extra features of the bigger models will be ignored when their file is loaded on a Qu-16. The extra features of the bigger models will be reset to factory default when a Qu-16 file is loaded.

Note To be compatible, ensure all your Qu mixers are loaded with the same version of firmware later. Check the Allen & Heath web site for the latest firmware available.

USB Audio - A USB hard drive formatted on one model can be used on the other. Stereo and multitrack Qu-Drive recordings are compatible. USB B audio streaming is compatible, but note that the Qu-16 is 24 out / 22 in, the Qu-24 is 32 out / 30 in, and the Qu-32 is 32 out / 32 in.

Firmware - Different firmware is needed for each model. Choose either the Qu-16, Qu-24 or Qu-32 file when downloading firmware from the Allen & Heath web site. The firmware version number will be the same for each update that is made available. The procedure for updating firmware is the same for all models.

Qu-Pad and Qu-You apps - These iOS apps are compatible with all Qu mixers. They identify the model and load the appropriate controls when you log in.

4. Connection Overview

The following connections are available on the rear panel of the Qu mixer. The Qu-16 is shown here.

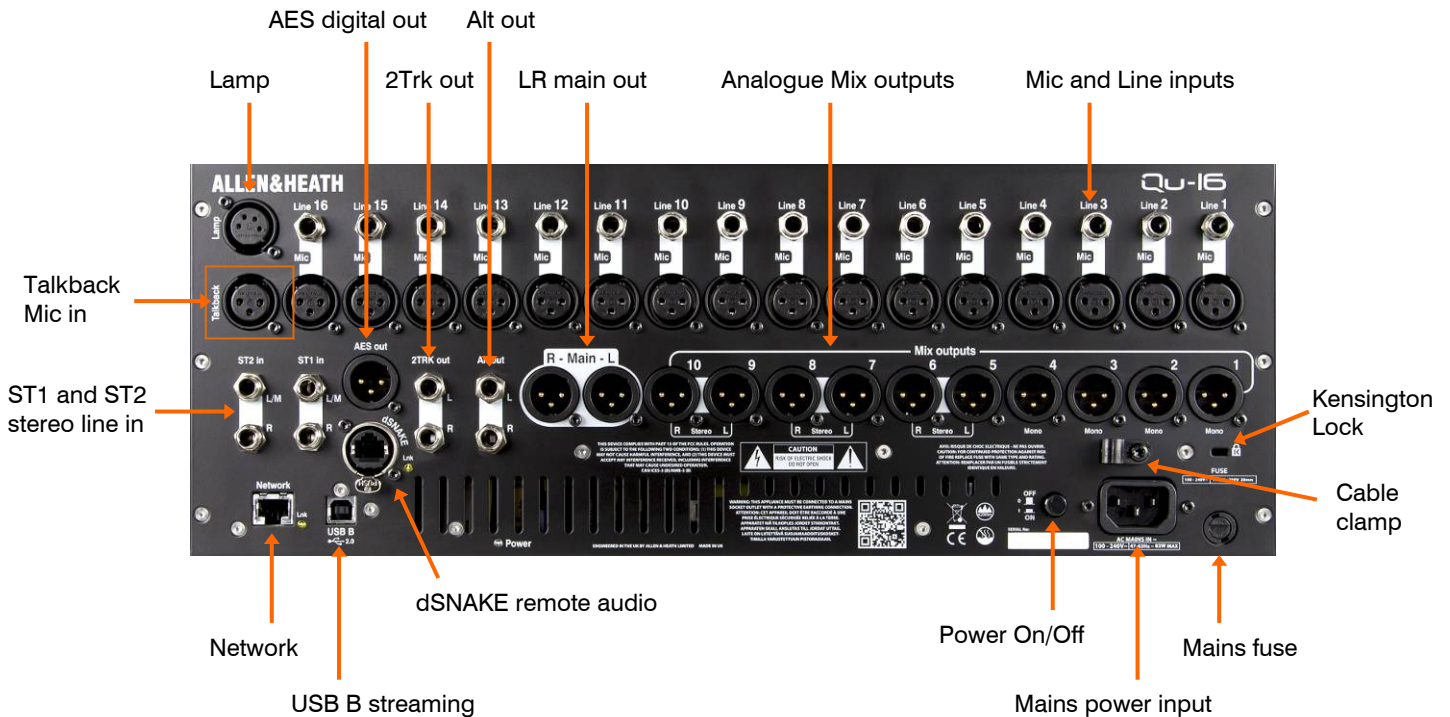

4.1 Local Input Connections



Pin2 = hot



Mono Line Input – Balanced 1/4" TRS (Tip, Ring, Sleeve) jack input for plugging in line level signals such as multitrack players and radio mic receivers. To work with unbalanced sources use a mono jack or link ring to sleeve within the TRS stereo jack.

Use DI boxes plugged into the Mic input for high impedance, low level sources such as acoustic instrument pickups.

Microphone Input – Balanced XLR input for plugging in a low level source such as a microphone or DI box. 48V can be switched to the socket for condenser mics and active DI boxes that require phantom power.

Note - To avoid loud thumps, mute the channel before plugging in cables or equipment while 48V is turned on.

Stereo Line Input – ST1 and ST2 balanced 1/4" TRS (Tip, Ring, Sleeve) jack inputs for plugging in line level stereo sources such as CD players. The L input normals (switches) through the R input so that you can work with a mono source by plugging into just the L/M input.

To work with RCA phono connections use jack to RCA converter plugs.

Talkback Input – Dedicated balanced XLR input for plugging in a microphone to route to the mixes for the engineer to talk to the performers on stage. Phantom power can be switched to the socket for condenser microphones.

4.2 Local Output Connections



Pin2 = hot



Group, Mix, Matrix outputs – Balanced XLR line level outputs for the mono and stereo mixes, for example to feed monitor amplifiers, external processing devices, delay fill speaker systems and recording devices. These use low impedance, high quality differential driver circuits for connection to +4 or 0dBu equipment. Maximum output is +22dBu.

Professional equipment provides ‘balanced’ connections for maximum interference rejection over long cable runs. If you are connecting to ‘unbalanced’ equipment then make sure the XLR pin 3 (signal cold) is linked to pin 1 (signal ground).

Main LR output – Balanced XLR line level outputs for the main Left and Right stereo mix. These typically plug into the FOH speaker processor, amplifier or powered speakers.

AES out – 2-channel digital output using a single XLR connection and standard mic (2-core screened) audio cable. It follows the AES (Audio Engineering Society) digital audio standard and can connect to any equipment fitted with an AES input socket. The source to this output is patched using the **Setup / Output Patch / Surface** screen. Applications include the feed to a PA speaker processor, amplifier, stereo broadcast or recording device equipped with AES input.

Alt out – Stereo ‘alternative’ output on balanced TRS jacks for connection to +4 or 0dBu equipment such as zone feeds, fill speakers, broadcast or local monitor. The source to this output is patched using the **Setup / Output Patch / Surface** screen.

2TRK out – Stereo output on balanced TRS jacks for connection to +4 or 0dBu equipment such as stereo recorders. It follows the post master fader main LR mix.

4.3 Other Connections



Lamp – Plug in a 4-pin gooseneck lamp to illuminate the mixer surface. You can use any industry standard 12V, 5W or lower power lamp. We recommend the Allen & Heath LEDLamp with built-in thumbwheel dimmer.

USB B – Type B USB connection for multi-channel bi-directional audio streaming between the mixer and a computer. Follows the high speed USB 2.0 standard.

Refer to the Allen & Heath web site for information on Windows® and Apple® Mac drivers available for Qu.

Network – Fast Ethernet (100 Mbit/s) port for Cat5 cable connection to a computer for MIDI over TCP/IP control of mixer parameters, or to a wireless router (access point) for live mixing control using the Allen & Heath **Qu-Pad** app running on an iPad. The **Lnk** indicator flashes to indicate network activity.

dSNAKE – The proprietary Allen & Heath ‘digital snake’ connection for remote audio using an AR2412, AR84 or AB168 AudioRacks, and for personal monitoring using the ME Personal Mixing System.

4.4 Powering up the mixer

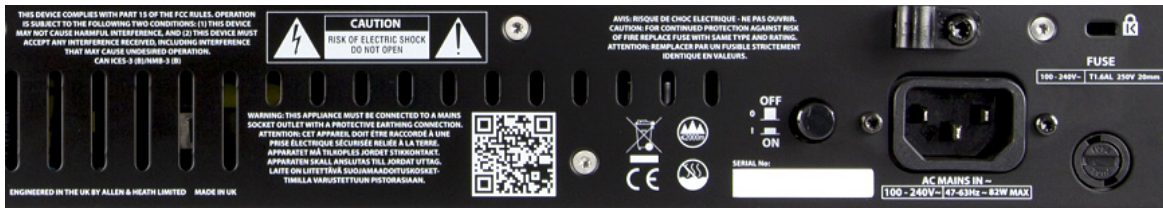

The Qu mixer has an internal universal voltage power supply unit. This means you can use your mixer in most parts of the world without the need to modify the unit as long the local mains supply is within the range:

Mains Voltage = 100 to 240 V.AC

Mains Frequency = 47 to 63Hz

Important - Before starting, read the **Safety Instructions Sheet** packed with the mixer. These can also be downloaded from the Allen & Heath website.

Also read the safety notes printed on the rear of the mixer.

AC MAINS IN – Standard IEC socket for connecting the mixer to the local mains supply. Plug in a mains lead with moulded plug suitable for your territory. A suitable mains lead is shipped with the mixer.

Note – Do not replace the mains plug or modify the lead in any way. For your own safety and that of the operator and performers do not remove or defeat the ground connection.

A **cable clamp** is provided. You can slot the cable into this or lock it in place. To lock the cable use a star head Torx T20 screwdriver to refit the clamp around the cable.

Fuse – Mains input fuse to protect the mixer circuits in the unlikely event of a failure or excessive power surge. If you need to replace the fuse always use one of the same type and rating as printed on the rear panel. If the replacement fuse blows then refer to your authorised Allen & Heath service agent for advice.

Power ON/OFF switch – Press to switch the mixer on. Press again to switch it off.

Switching the mixer on – Press the ON/OFF switch. The rear panel blue Power indicator lights. The mixer takes just a few seconds to boot up. It restores its previous settings. LR mix is selected and its processing shown on the screen.

Note – To avoid loud thumps, do not switch the mixer on or off while the PA speakers are powered. Always switch the amplifiers on last, and switch them off first.

Switching the mixer off – First select the **Home** screen. Touch **Shut Down** to safely complete processes such as parameter storing and USB data transfer or recording. Once complete, press the ON/OFF switch to turn the mixer off.

5. Connecting dSNAKE Remote Audio

The Qu mixer provides local sockets on its rear panel for all audio inputs and outputs. It can also work with remote audio by connecting over a single cable 'digital snake' to an Allen & Heath AudioRack, or to the Allen & Heath ME Personal Mixing System.

5.1 Connecting to a remote AudioRack

The Qu can connect to an Allen & Heath AudioRack so that the audio can be plugged into a rack on stage and routed to the mixer over a single Cat5 cable 'digital snake' plugged into its dSNAKE port.



dSNAKE carries:

- Up to 38 remote input signals
- Up to 16 remote output signals
- 40 personal mixing sends
- Preamp control – Gain, Pad, 48V



The Qu mixer provides a locking Neutrik EtherCon socket to protect the connections and ensure suitability for touring. Use a touring grade cable fitted with locking EtherCon plugs.

Maximum cable length = 120m (396') depending on cable type. Recommended maximum length = 100m (330').



Connecting Qu to the AudioRack – Plug one end of your Cat5 'digital snake' into the Qu mixer dSNAKE port. Plug the other end into the dSNAKE port of the AudioRack.

Connecting a second AudioRack – The AR2412 and AB168 AudioRacks include an EXPANDER port. You can use this to connect to an AR84 or AB168 AudioRack.

Note – The AR2412 AudioRack cannot be used as an expander in a Qu system.

Note – You can connect up to two AudioRacks in a Qu system. This includes the main rack and one expander rack.

Once connected and powered up, the Qu touch screen should display the 'dS' icon in its toolbar to show that one or more dSNAKE devices are recognised by the system.



Available AudioRacks:

AB168 16 Mic/Line in, 8 Line out - Floor, shelf or rack mount

The AB168 AudioRack can be used as a stage box on the floor or a surface, or mounted in a 19" rack using the optional rack ears.



EXPANDER – To connect to a second AB168 to add more input and output sockets. Also compatible with the Allen & Heath ME personal mixing system.

dSNAKE – To connect to the Qu mixer using a Cat5 digital snake.

AR2412 24 Mic/Line in, 12 Line out - Rack mount



EXPANDER – To connect to an AR84 or AB168 to add more input and output sockets.

MONITOR – To connect to the Allen & Heath ME personal mixing system.

dSNAKE – To connect to the Qu mixer using a Cat5 digital snake.

AR84 8 Mic/Line in, 4 Line out - Rack mount



EXPANDER – To connect to the Expander port of the AR2412, or connect directly to the Qu mixer via its dSNAKE port.

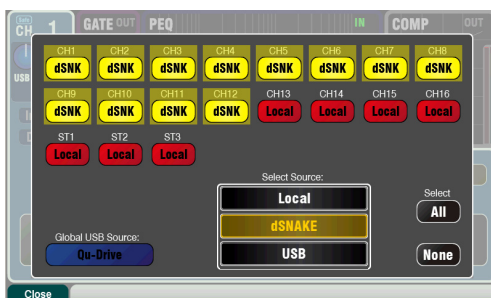

Inputs – Use the **Preamp** screen **Fn** key **Source** page to choose either 'Local' or 'dSNK' (remote) for each channel source. AudioRack Input sockets are not patchable. They are mapped one-to-one to each Qu channel.

Note – Adding an AudioRack does not expand the number of Qu channels available.

Outputs – The Qu mixer outputs will appear simultaneously at its rear panel sockets and also at the sockets on the remote rack. AudioRack output sockets are patchable. Qu outputs can be patched to the rack sockets using the **Setup / Output Patch / dSNAKE** screen.

5.2 Qu Systems

The Qu mixer has sockets for all its inputs and outputs on its rear panel and can therefore be used without any additional rack. However, if you wish to use a digital snake to connect remote stage audio to the mixer using a single Cat5 cable then there are several rack options available. The following diagrams show suggested combinations:

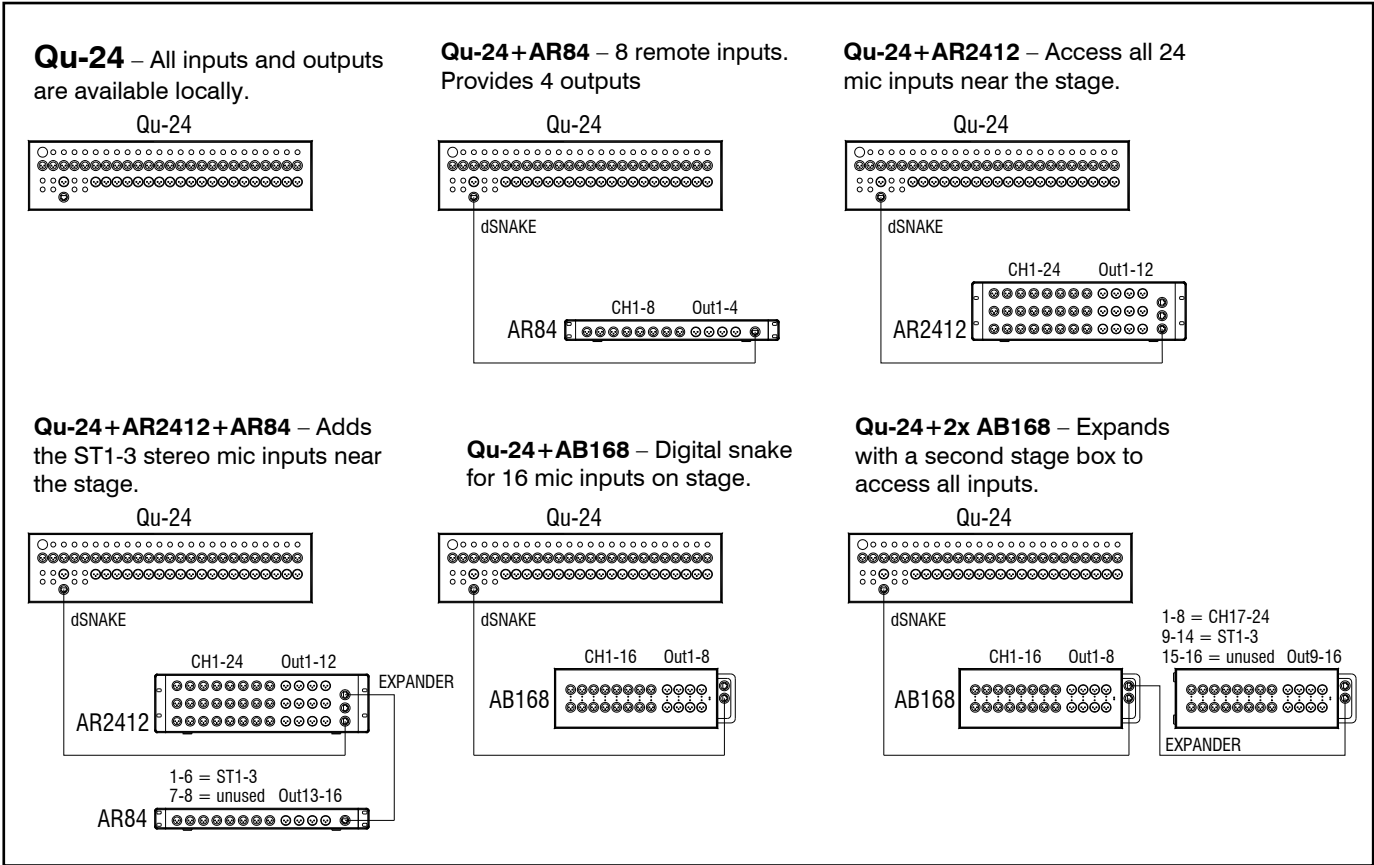
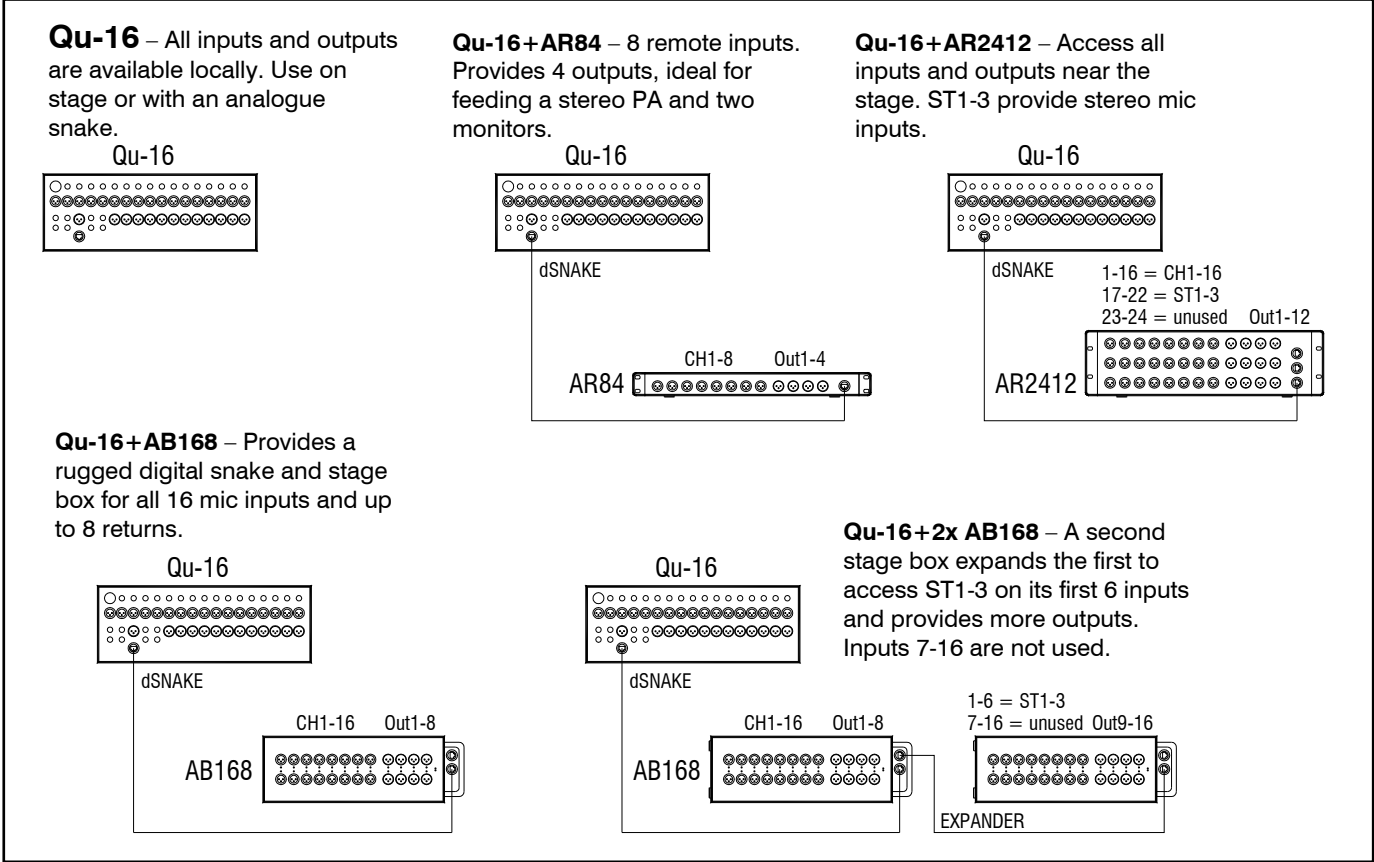

Qu-32 – All inputs and outputs are available locally.

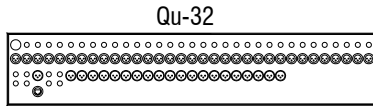

Qu-32+AR84 – 8 remote inputs. Provides 4 outputs

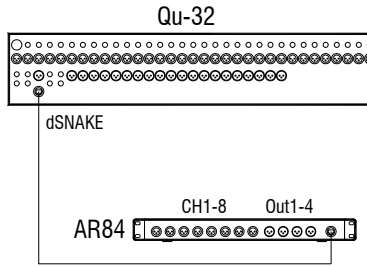

Qu-32+AR2412 – Access to 24 mic inputs near the stage.

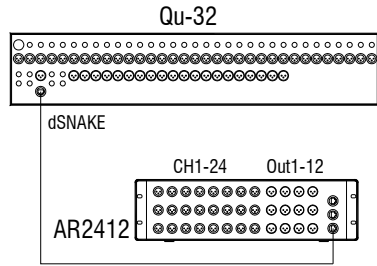

Qu-32+AB168 – Digital snake for 16 mics on stage.

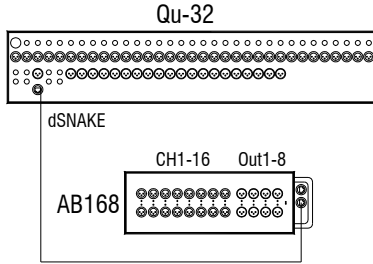

Qu-32+2x AB168 – Add a second AB168 for 32 mics on stage.

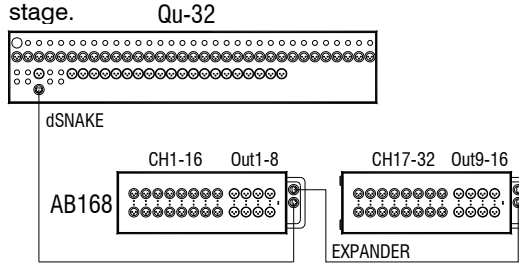

Qu-32+AR2412+AR84 – Provides all 32 mic inputs near the stage.

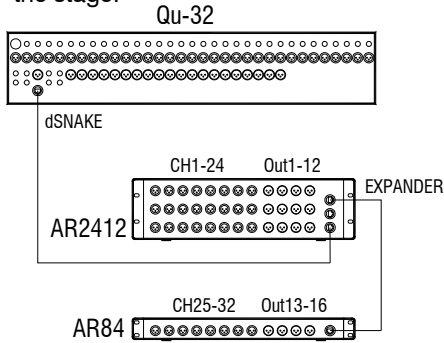

Qu-32+AR2412+AB168 – Access to all inputs including stereos.

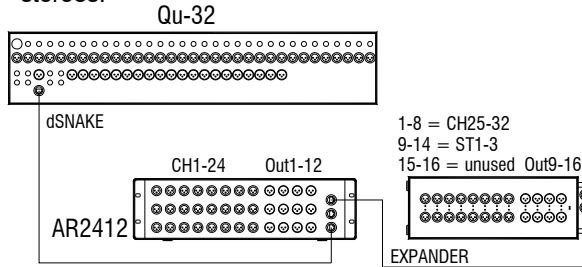

ME Personal Mixing System – The Qu system can interface directly or via the ME-U hub to ME-1 personal mixers using any available dSNAKE, EXPANDER or MONITOR port.

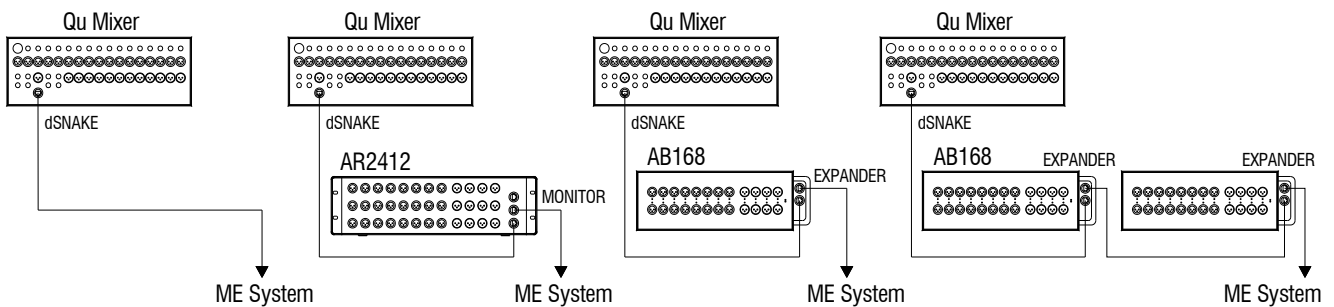

Parallel connection

Use the ME-U hub or a standard PoE hub to power and connect to several ME-1 mixers using individual Cat5 cables.

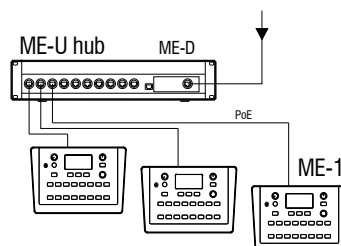

Daisy chain connection

Connect to Link In of the first ME-1 mixer. Connect its Link Out to daisy chain to the next. Use the power units provided with each ME-1 mixer.

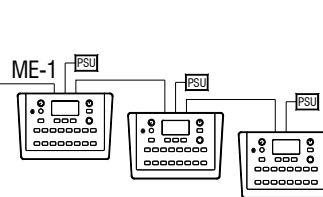

5.3 The ME Personal Mixing System

The Allen & Heath ME Personal Mixing System can be used with the Qu mixer. This provides customisable personal monitor control for individual musicians and performers on stage.



ME-1 personal mixer – A compact personal mixer able to work with up to 40 channels. Features built-in headphones and monitor output. Intuitive and easy to operate, its 16 select keys can be configured to provide as much or as little control as the musician needs.

The 40 ME channels are mapped from the Qu input channel direct outputs, FX and mixes to dSNAKE. Qu sends audio and stereo status information. Channels can be chosen and grouped to ME-1 keys using the setup function available on the ME-1 mixer.

Multiple ME-1 mixers can be connected in series (daisy chained) by linking the output of one to the input of the next. Alternatively, they can be connected in parallel and powered over their Cat5 cables using a standard PoE Ethernet switch or the Allen & Heath **ME-U** hub. The ME connects directly to a dSNAKE compatible port using a Cat5 cable.

Connecting ME to the AR2412 AudioRack - ME-1 mixers, a standard Ethernet switch or the ME-U hub can be plugged into either or both the AR2412 MONITOR and EXPANDER ports.

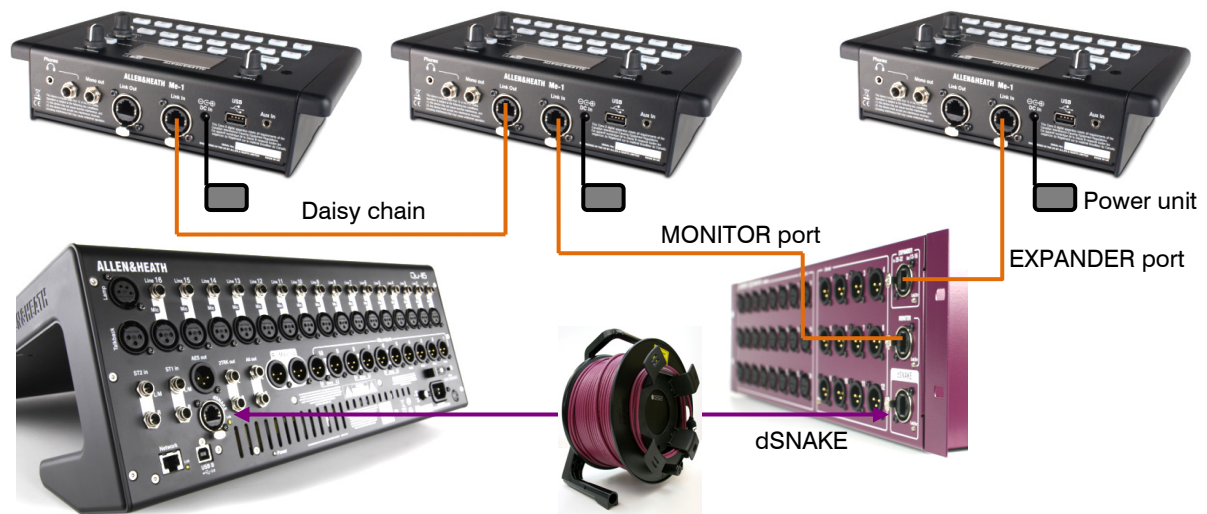

Connecting ME to the Qu mixer - ME-1 mixers, a standard Ethernet switch or the ME-U hub can be plugged directly into the Qu dSNAKE port if you are not using this to connect to an AudioRack. Power can be provided over the Cat5 by the ME-U or a PoE switch.



Find out more about the ME Personal Mixing System at www.allen-heath.com

6. Operational Overview

This section provides an overview of the Qu layout and operation to help you get started quickly. The Qu-16 mixer is shown here.

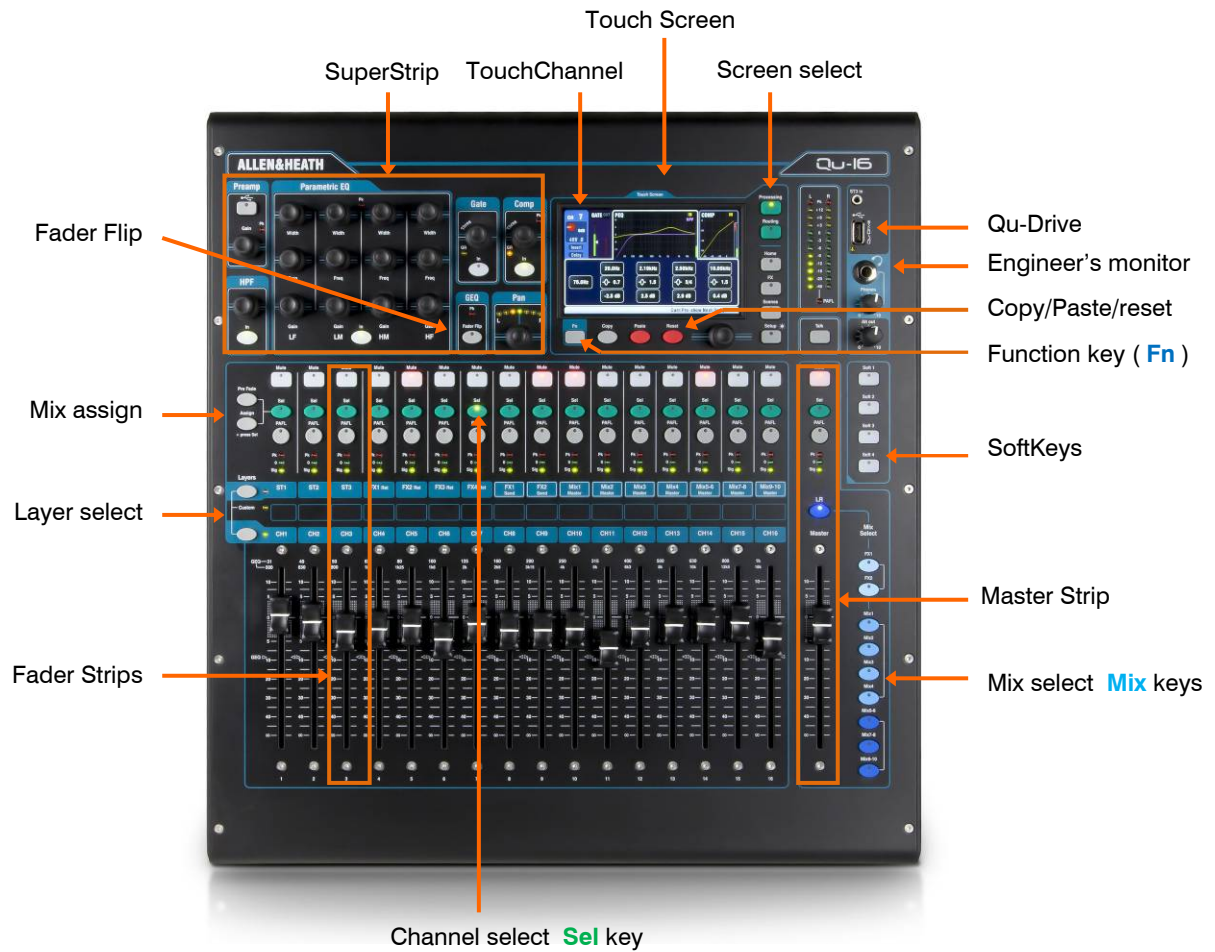

6.1 Fader Strips



The Qu mixer has a group of fader strips, one per channel. These provide access to the input and master channel levels and processing.

The main channel levels, master levels and all sends to the FX and mixes can be easily viewed and adjusted using the faders. The faders can also be used to adjust the Graphic EQ while in Fader Flip mode.

The faders are motorised and instantly move to show the current settings when the layer or function is changed.

Layers – There are three Layers. These provide access to inputs and masters as identified by the labels alongside the layer select keys. Indicators next to the keys show which layer is active.

Press the lower key to access the mono channels.

Press the upper key to access the 3 stereo channels, FX returns, FX sends and Mix masters.

Press both keys together to access the user assignable Custom layer.

Note – There is an option in the **Setup / Control / Custom Layer** screen to enable 'Custom Layer only'. This lets you choose which channels the user should have access to.

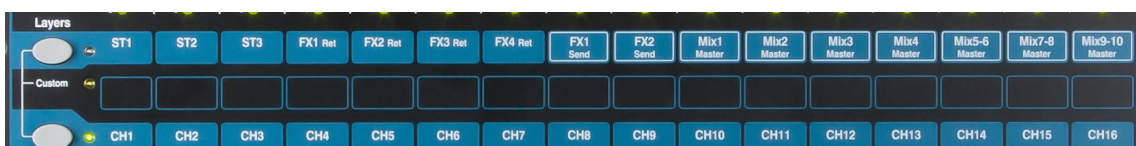



Mute key – Press to turn off the channel audio signal. This affects the send to all mixes including LR, groups, effects and stage monitors. The key lights red when muted. It flashes when muted by a Mute or DCA Group master.

Sel key (select) – Press to access the **Channel Processing**. Parameters can be adjusted using the SuperStrip controls. The touch screen will display the settings and provide additional controls if either the **Processing** or **Routing** screen is active. The Sel key is also used for:

Assign mix routing – Hold down the ‘Assign’ key and press Sel keys to assign channels to the mix currently selected in the Master Strip. The Sel keys light green to show channels assigned to the selected mix.

Assign Pre/Post fade sends – Hold down the ‘Pre Fade’ key and press Sel keys to toggle channel sends pre or post fader for the mix currently selected in the Master Strip. The Sel keys light green to show channels set pre-fade.

Copy channel processing – Hold down the Copy key and press a channel Sel key to copy its processing settings. Then hold down the Paste key and press one or more Sel keys to instantly paste those settings to other channels.

Reset channel processing – Hold down the Reset key and press a channel Sel key to instantly reset all its processing to factory default.

Reset Graphic EQ band – Press Sel to reset the associated GEQ frequency band to 0dB while in GEQ Flip mode.

PAFL key – Press to listen to a channel using headphones and check its level on the main meters. The meter PAFL indicator lights. Press PAFL again to turn it off. A SoftKey can be assigned to clear all active PAFL selections. Options are available in the **Setup / Audio / PAFL** screen to choose how you want PAFL to work:

Additive mode – Pressing a PAFL key automatically cancels any previous selection. Turn Additive on to PAFL more than one channel at a time.

Sel follow PAFL – Link the Sel switch so that pressing PAFL automatically selects the processing for that channel.

LR to PAFL – Routes the main LR mix to the monitor when there is no PAFL selected.

Output AFL – This option sets the mix strip PAFL keys to monitor AFL (after-fade listen). With this option turned off these keys monitor PFL (pre-fade listen). The default is AFL so that you can check mixes after the master fader.

Input AFL – This option sets the input strip PAFL keys to monitor AFL (after-fade listen). With this option turned off these keys monitor PFL (pre-fade listen). PFL is the usual setting for inputs so that you can check and set their gain before you bring up the faders.

Channel meter – The strip meters let you keep an eye on signal levels while you are mixing. These display channel level before the fader and mute control:

Pk – Lights red to warn that the signal is too hot and gain or trim should be reduced. It turns on 3dB before clipping to warn you before audible distortion. Pk senses the signal at several points within the channel.

0 – Lights when the signal reaches nominal 0dBu allowing a healthy 18dB headroom. This is the normal level for mixing.

Sig – Lights to show signal presence. It turns on at -26dBu.

Fader – Controls the level of the input channel, FX or mix master assigned to it. This can be the main channel fader or a send to an effect or mix depending on which Mix Select key is active in the Master Strip.

The faders can also control the Graphic EQ frequency bands while in GEQ Flip mode. The range of frequencies accessed by the faders is highlighted in the touch screen and labelled at the top of the faders. The centre 0dB flat position is marked on the fader scale.

6.2 Channel Naming

Qu channels, FX, mixes and groups can be named using the screen keypad. The following can be named:

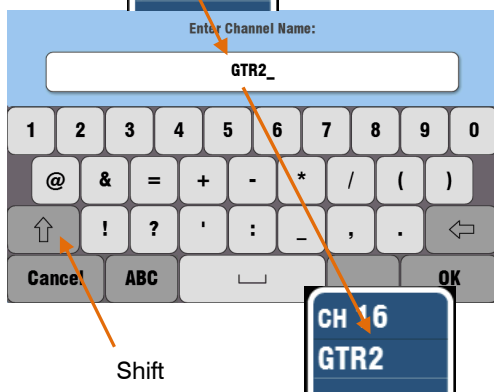

- Mono input channels
- Stereo input channels
- FX Returns
- FX Sends
- Mix
- LR
- Groups
- Matrix
- Mute Groups
- DCA Groups

Channel names

The name is displayed at the top left of the **Processing** and **Routing** screens. The name can be edited from the **Processing** screen.

The pencil icon appears when the name is blank. All names are cleared when the Qu mixer is reset or the 'Reset Mix Settings' scene is recalled.

Touch the name box to open the screen keypad and edit the name.

Names can have up to 6 characters.

Touch the Shift button to type in an uppercase character. Touch the button twice for Caps Lock.

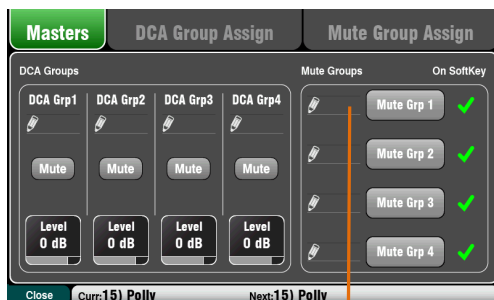

Mute and DCA Group names

Open the **Routing** screen **Fn** key **Mute/DCA** page to view the Mute and DCA Group masters. Their names are displayed.

Touch a name box to open the screen keypad and edit the name.

Qu-Pad iPad app names

Names stored in the Qu mixer are sent to the iPad. These are displayed and can be edited using the iPad.

Names and Scene memories

Names are stored as part of the Qu mixer Scene memories.

You can block or allow names in Scene recall using the Global and per scene Filters. Three filter items affect names:

- Input/FX Names – CH, ST, Groups and FX Returns
- Output Names – FX Sends, Mix, LR, Matrix
- Mute/DCA Grp Masters – Mute and DCA names

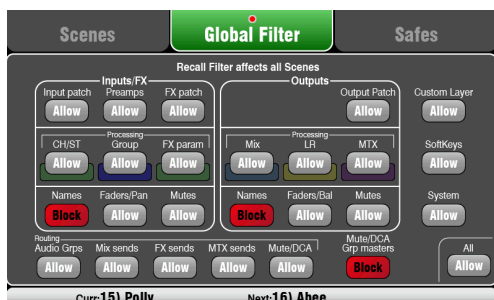

6.3 Channel Processing

The **SuperStrip** provides familiar, analogue feel, one function per knob control of channel and mix master processing such as equalisers and dynamics. The Touch Screen displays the parameter values and provides additional related controls while in the **Processing** screen. This processing is accessed using the fader strip **Sel** keys.



The following processing is available:

Mono input CH	= Source, Preamp, HPF, Gate, PEQ, Compressor, Delay, Stereo Linking
Stereo input ST1-3	= Source, Preamp, HPF, Gate, PEQ, Compressor, Delay
FX Return 1-4	= FX parameters, PEQ
Groups (not Qu-16)	= Parametric EQ, Graphic EQ, Compressor, Delay
Mix1-10, LR	= Parametric EQ, Graphic EQ, Compressor, Delay
Matrix (not Qu-16)	= Parametric EQ, Graphic EQ, Compressor, Delay

6.4 Working with the Processing:

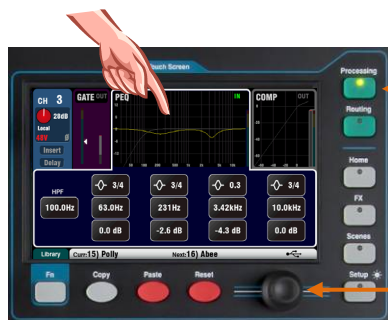

- Press a fader strip **Sel** key. The Processing Block controls become active for that channel.
- Press the **Processing** key to work with the parameters on the Touch Screen.
- Touch the top part of the Touch Screen to open the tabs for the available processing blocks.
- View values in the lower part of the screen. Touch screen buttons and use the screen rotary to adjust parameter values.

6.5 Working with Processing Libraries:

User Library – Store your own settings.

Factory Library – Provides a starting point for mixing.



- Press the 'Library' **Fn** key to open and close the related **Library** page.
- Use the left hand list for individual processing libraries or the right hand list for complete input channel processing libraries including the preamp.
- **Store** - Touch 'Store New'. Enter a name using the screen keypad to store a new User Library. You can store up to 128 Libraries.
- **Recall** - Highlight a library item and touch 'Recall' to instantly recall its settings. Turn on 'Recall Preamp' if you want to recall the preamp settings.
- **Edit** – Highlight a library item and touch 'Overwrite' to overwrite an existing library with the current settings, or 'Delete' to delete it from the list. Touch the 'Name' box to edit its name.

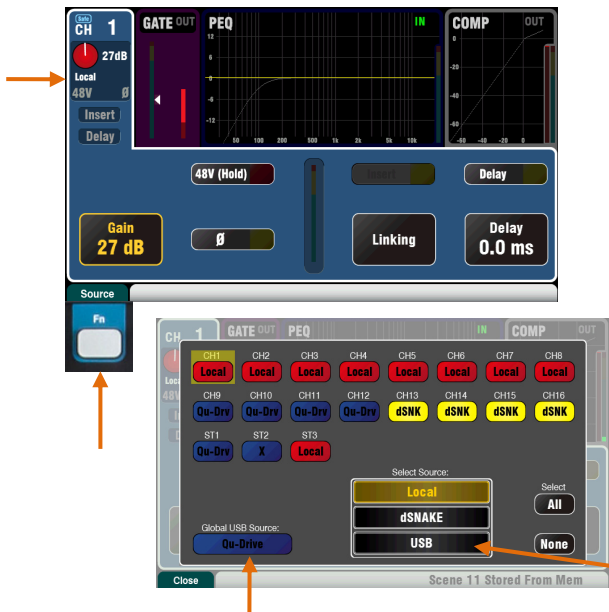

Choose either Qu-Drive or USB (affects all channels)

Preamp

An analogue preamplifier ('head amp') matches each connected microphone or line signal to the operating level of the console before it gets converted to digital to be processed and mixed with the other channels.

Source lets you choose one of four sources as the input to the channel:

- Local** – Mic/Line sockets on the Qu rear panel.
 - dSNK** – Remote preamps via dSNAKE.
 - Qu-Drv** – Playback from USB hard drive.
 - USB B** – Audio streaming from a Mac computer.
- Press the **Fn** key to open the **Source** screen.

Touch the CH buttons to highlight those you wish to change. Select the source from the list.

Local (red Gain)

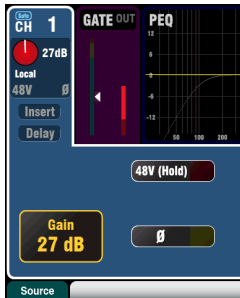

dSNAKE (yellow Gain)

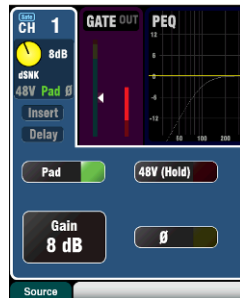

Qu-Drive (dark blue Gain)

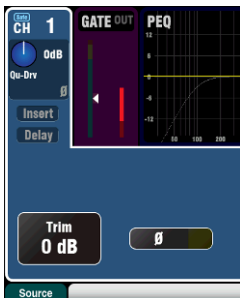

USB B (Light blue Gain)

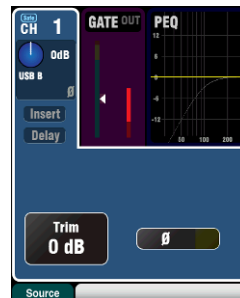

Channel Preamp source

Local (red Gain) – Rear panel Mic/Line sockets feeding the internal Qu mixer preamps. These are pad-less preamps featuring wide gain range.

dSNAKE (yellow Gain) – Remote preamps located in an AudioRack on stage or other remote location and connected to the Qu dSNAKE port via a Cat5 cable. The AudioRack preamps include 20dB Pad switching.

Channel USB source

Qu-Drive source (blue Gain) – Stereo or multitrack playback from a USB hard drive plugged into the top panel Qu-Drive port. Provides a +/-24dB Trim control.

USB B source (blue Gain) – Multi-channel streaming from a Mac computer via the rear panel USB B port. Provides a +/-24dB Trim control.

The panel **USB Select** key in the SuperStrip switches between the current Preamp source (Local or dSNAKE) and the current USB source (Qu-Drive or USB B).

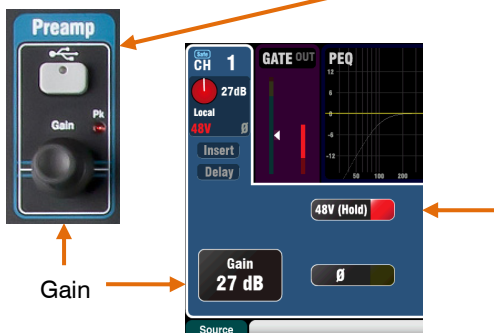

Phantom Power

Turn on **48V** if the connected device requires phantom power, for example a condenser microphone or active DI box. Touch and hold for 1 second to toggle on or off. This prevents accidental operation.

Note - To prevent audible thumps make sure the channel is muted before switching 48V on or off. Do not plug or unplug sources while phantom power is on.

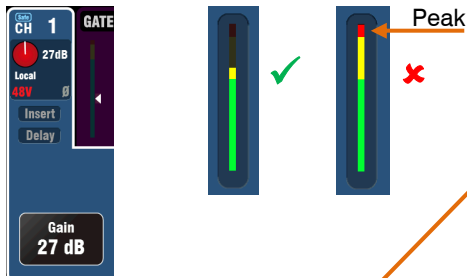

Gain

Turn up Gain so that the average loud signal reads into the yellow of the meter. Turn down if any red peak light flashes.

Polarity

Touch \emptyset to reverse the polarity of the input signal, for example that of the lower mic when working with two microphones on a snare drum.

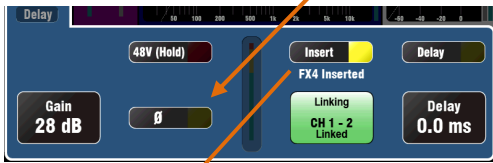

Other functions in the Preamp section

Insert switches an internal FX in or out if one has been patched into the channel. The button is disabled when the insert is not patched. The FX is inserted between the preamp and EQ.

Use the **FX / Back panel** screen to choose and assign one of the 4 internal FX as an Insert into a channel.

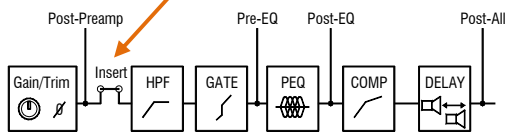

Delay up to 85ms can be added to each input channel. In most cases delay is not needed, but can be useful in time aligning sound from the PA to the acoustic sound from an instrument on stage. Allow 1ms per foot distance as a starting point.

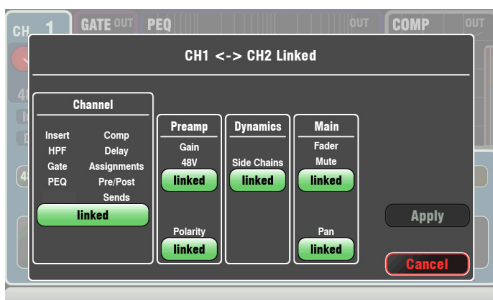

Linking lets you gang the preamp, processing and routing of an odd/even mono channel pair for stereo operation. All parameters including the preamp, processing and routing are linked. Pan becomes a width control when linked. Some parameters can be removed from the link using the buttons:

- Preamp – Gain/Pad/48V, Polarity
- Dynamics (Compressor and Gate) - Side Chains
- Main mix – Fader/Mute, Pan

Touch **Apply** to accept your changes.

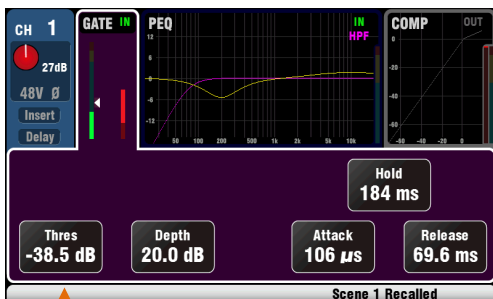

Gate

The Noise Gate can be switched in to dynamically turn off the audio when it drops below a certain level. For example, to reduce resonant decay of a kick drum or floor tom, or hiss of a noisy keyboard.

Use the **In** key to switch the Gate in or out. This is similar to inserting an outboard rack mounted device into the Insert socket on an analogue console channel.

Set **Depth** for how much signal reduction you want when the gate closes. 20dB is a typical setting. Sound check the instrument and reduce **Threshold** to shut off as much of the tail of the signal as you want. The **GR** indicator lights and red screen meter shows the amount of reduction when the gate is closed.

Note – The lower part of the Gate meter is a darker green to show signal 'noise' level below -40dB.

Hold sets how long the gate remains open after dropping below the threshold. **Attack** sets how fast the gate opens when the signal rises above the threshold. **Release** sets how fast it closes when dropping below the threshold. Experiment with these controls to achieve smooth operation without a pumping effect.



Gate active
GR = Gain Reduction

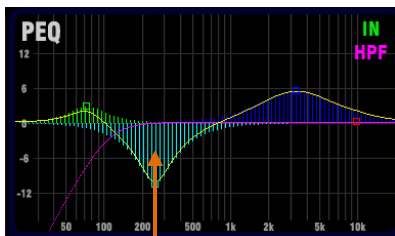
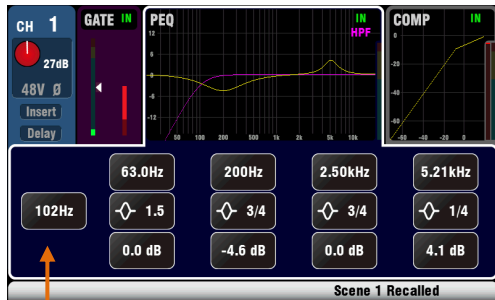

Touch the curve to turn the colour fill option on or off.



HPF (high pass filter)

The HPF is used to reduce unwanted low frequency sounds such as vocal popping, wind noise and stage rumble.

Switch the HPF in using the **In** key. Use the panel rotary or screen button and rotary to sweep the cut-off frequency until you have reduced the unwanted sound. The filter has a 12dB slope and can be swept from 20Hz to 2kHz. The violet screen curve shows the resulting frequency response.

PEQ (parametric equaliser)

The Parametric Equaliser allows tonal adjustment of the channel sound. It provides independent control of 4 frequency bands:

- LF (low frequency)
- LM (low mid frequency)
- HM (high mid frequency)
- HF (high frequency)

Each provides 3 parameters that can be adjusted:

Gain – Boost or cut frequencies by up to 15dB. Centre 0dB is flat response (no affect).

Frequency – Each band can sweep its centre point frequency across the full range from 20Hz to 20kHz. This means you can overlap bands and have more precise control over problem frequency areas.

Width – Each band has a bell-shaped response. The width of the bell can be varied from a very wide 1.5 octaves affecting many frequencies to a very narrow 1/9th octave affecting a small range of frequencies. Setting LF or HF to widest position using the screen rotary changes its response to shelving.

Experiment with the controls to hear their affect on different sounds. Switch the PEQ in or out using the **In** key to compare the sound. It is better to cut rather than boost frequencies where possible.

Compressor

The Compressor is a powerful tool for controlling the dynamics of the sound, for example to smooth out a bass guitar or to narrow the dynamic range of a vocal to make it more intelligible in a busy mix. At its extreme setting the compressor can be used as a limiter to prevent the signal exceeding a preset maximum level.

A compressor works by dynamically reducing the amount of gain when the signal increases above a certain threshold. This pulls back loud moments. Applying 'make-up' gain restores the average volume and also has the effect of bringing up quiet moments. The result is a reduced dynamic range.

While listening to the signal adjust **Thres** (threshold) to set the point at which compression starts. The GR indicator and red screen meter will start to show that compression is active. Set **Ratio** for how much compression you want from none (1:1) to full limiting (Inf). A ratio of 3:1 is a good starting point.

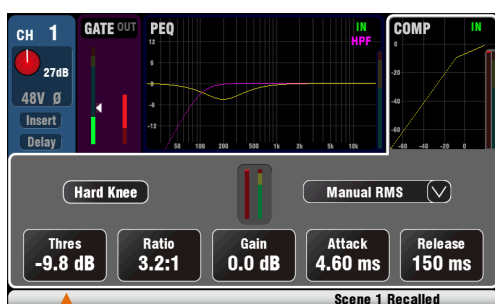

Compressor active
GR = Gain Reduction

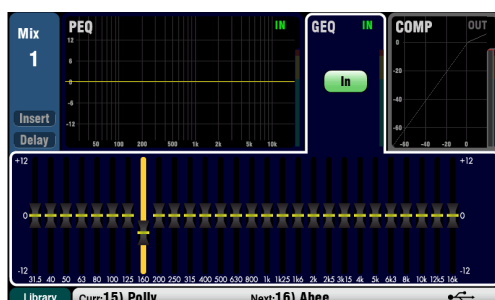
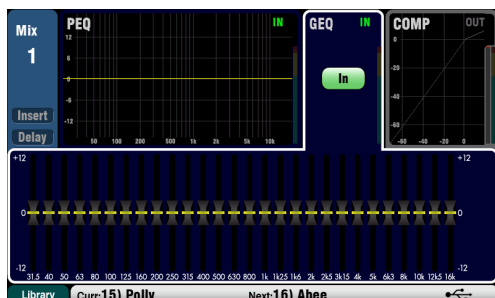
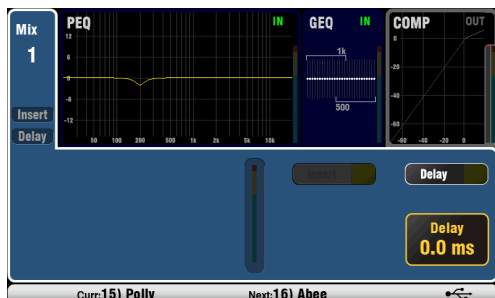
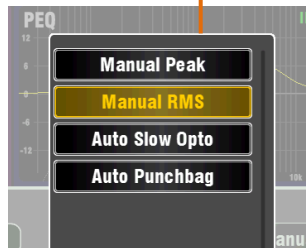
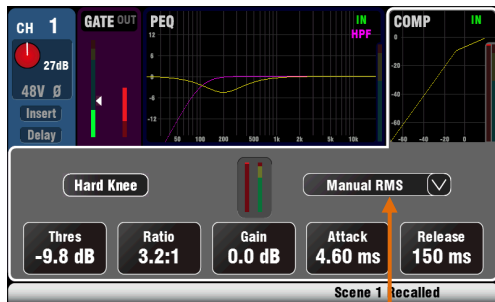

Use the **In** key to switch the compressor in and out and turn up **Gain** so that the average volume is similar.

Attack sets how fast the compressor starts to work when the threshold is reached. **Release** sets how fast it stops compressing when the signal drops below the threshold. For example, adjust these to achieve a 'punchy' dynamic sound, or smooth out the response to reduce an audible 'pumping' effect.

Two 'knee' settings are available. **Hard Knee** means that compression is applied at the set ratio as soon as the threshold is reached. **Soft Knee** means that the compression ratio increases gradually from 1:1 to the set ratio as it approaches the threshold. The curve illustrates this.

4 Compressor types are available using the drop-down menu. Two 'Manual' types allow user control of attack and release. Two 'Auto' types provide automatic control of the compressor dynamics.

Experiment with the effect of the compressor settings on different sounds. Try to use compression only where it is needed, and avoid compression in stage monitor speakers.

Mix processing

The mix masters provide PEQ, GEQ, Compressor, FX Insert capability and output Delay.

To access the Mix processing press its master strip green **Sel** key.

Insert switches an internal FX in or out if one has been patched into the mix. The button is disabled when the insert is not patched. The FX is inserted at the start of the processing before the EQ.

Use the **FX / Back panel** screen to choose and assign one of the 4 internal FX as an Insert into a mix.

Delay up to 170ms can be added to each mix output. This is typically used to time align the PA to the acoustic sound from the instruments on stage, or to align fill loudspeakers to the main PA. Allow 1ms per foot distance as a starting point.

GEQ (graphic equaliser)

The Graphic EQ is a popular tool for tuning out resonant frequencies in PA systems, for example when ringing out monitor speakers.

The GEQ allows tonal adjustment of the overall mix sound. It splits the 20Hz to 20kHz audio frequency range into 28 standard 1/3 octave bands from 31.5Hz to 16kHz allowing +/-12dB cut or boost.

Touch the screen **In** button to switch the GEQ in or out. Touch a slider to highlight it and use the **screen rotary** to cut or boost its frequency. This affects a small range of frequencies 1/3 octave wide centred on the frequency marked below the slider. The position of the sliders shows the approximate shape of the resulting frequency response curve.

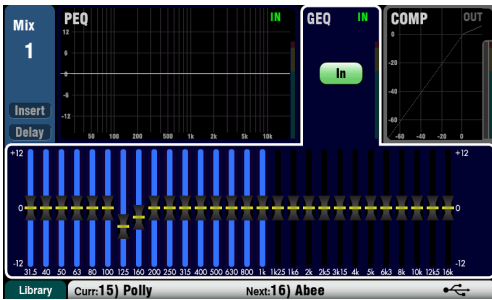

Press the **GEQ Fader Flip** key to view and adjust the GEQ on the faders while a mono or the LR mix is selected. The screen highlights the active range of frequencies. Press the switch again to change range or return to normal mix mode.

The faders toggle between the lower and higher ranges of frequencies with a useful overlap. The frequencies are shown on screen and marked on the panel above the faders.

The fader strip **Sel** key turns on when the slider is at 0dB mid (flat) position while in fader flip mode. Press a Sel key to return a slider to 0dB.

It is better to cut rather than boost frequencies when tuning speakers using the GEQ.

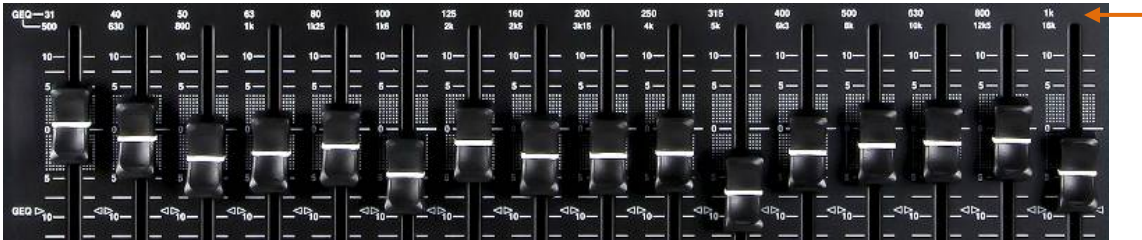

6.6 Processing Libraries

Processing block settings can be stored as Libraries:

- PEQ
- GEQ
- Gate
- Comp
- Channel (Preamp, Gate, PEQ, Comp, Delay)

You can store up to 128 library items including all types.

Press the **Fn** key on the related **Processing** screen to open the **Library** page. The Channel library is available from its Gate, PEQ and Comp screens.



Channel Library – This is available for the mono and stereo input channels

Turn the 'Recall Preamp' option on if you want to recall the input preamp settings along with the processing. This includes the settings for all its preamp sources - Local, dSNAKE and USB.

Factory Libraries – Built-in libraries are available as examples or to give you a starting point for live mixing. These cannot be deleted or edited.

User Libraries – You can name and save your often used settings for quick recall. User libraries can be overwritten, renamed and deleted using this screen.

Library lists – The left hand list displays related processing block libraries, for example the PEQ. The right hand list displays libraries for complete input Channel processing.

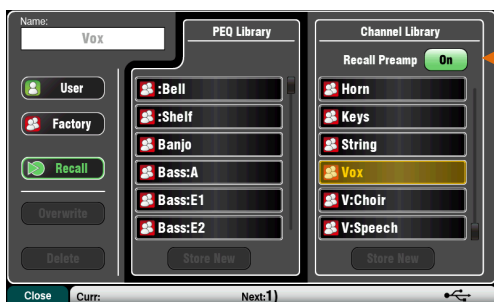

Note There is no 'standard' setting for instruments in live mixing as many factors affect the sound, for example the instrument itself, its pickup, the mic used, room acoustics and more. For this reason the **Factory** libraries simply provide a starting point or examples. You can also save your preferred settings as **User** libraries.

6.7 List of Factory Libraries

PEQ	:Bell	Flat - 4 bell @ 0.5 octave
	:Shelf	Flat - Shelving LF and HF
	Banjo	Banjo pickup or mic
	Bass:A	Acoustic (upright) bass
	Bass:E1	Electric bass - Deep
	Bass:E2	Electric bass - Punch
	Drm:KK1	Kick drum - Rock
	Drm:KK2	Kick drum - Jazz
	Drm:SN1	Snare drum - Standard
	Drm:SN2	Snare drum - Deep
	Gtr:A1	Acoustic guitar - Mellow
	Gtr:A2	Acoustic guitar - Bright
	Gtr:E1	Electric guitar - Mellow
	Gtr:E2	Electric guitar - Bright
	Horn	Brass instrument - Sax
	Keys:1	Keyboard - Full
	Keys:2	Keyboard - Tight
	Stomp	Foot stomp box
	String:1	String instrument - Full
	String:2	String instrument - Mellow
Vox:1	Vocal mic	
Vox:2M	Male vocal	
Vox:3F	Female vocal	
V:Choir	Choir mic	
V:Speech	Speech mic (talking)	
Gate	:Slow	Slow response
	:Fast	Fast response (percussion)
	:Noise	Subtle reduction of noise
	Drum	Kick and tom drums
Comp	:Gentle	Subtle compression 2.2:1
	:Heavy	Heavier compression 3.2:1
	:Limit	Protection limiting
	Bass:1	Soft bass compression
	Bass:2	Punchy bass compression
	Vox:1	Soft vocal compression
	Vox:2	Vocal compression
Vox:3	Strong vocal compression	
GEQ	Wdg:Vox	Vocal wedge monitor - reduce feedback

Channel	:Mic	Vocal or instrument mic
	:Line	Line level source
	:DI 48V	With 48V on for DI box
	Bass:A	Acoustic (upright) bass
	Bass:E	Electric bass
	Drm:Hat	Hi-hats
	Drm:KK	Kick (bass) drum
	Drm:OH	Overhead for cymbals
	Drm:SN	Snare drum
	Drm:Tom	Tom drum
	Gtr:A	Acoustic guitar
	Gtr:E	Electric guitar
	Horn	Sax, trumpet, trombone
	Keys	Keyboard, electric piano
	String	Stringed instruments
	Vox	Vocal mic
	V:Choir	Choir mic
	V:Speech	Speech mic (talking)

Channel Libraries are intended to provide a useful [starting point for live mixing](#). Settings are mostly flat with parameters set to typical values for the associated source.

These libraries are available for the mono and stereo input channels. They recall all processing settings including Gate, PEQ and Compressor. They can also recall the Preamp settings such as Gain, 48V and Polarity if you turn the 'Recall Preamp' option on.

Recall these libraries while setting up the mixer before sound check. When sound checking each instrument, start by checking its preamp Gain and then dial in EQ Gain and Gate/Compressor Threshold.

PEQ, GEQ, Gate, Comp Libraries recall just their associated parameters and are intended to provide [examples to demonstrate](#) how the processing can be used with different instruments and sources.

Libraries starting with ' : ' can give you a general purpose starting point.

PEQ libraries store and recall both the HPF and PEQ settings.

6.8 Channel Routing

The Touch Screen presents tabs to access the channel assignments and send levels when its fader strip **Sel** key is selected and the Touch Screen **Routing** screen is active. The Channel Block **Pan** control provides quick access to the related mix pan setting for the channel. The **Fn** key is used to access the Mute Group masters while in any Routing screen.



6.9 Working with the Routing screens



- Press a fader strip **Sel** key.
- Press the Touch Screen **Routing** key.
- Touch the tabs at the top of the screen.
- Touch screen buttons and use the rotary.
- Press the **Fn** key to access the Mute and DCA Groups.

Pan

The rotary Pan control becomes active when an input channel **Sel** key is active. Its function depends on currently selected Master Strip mix:

- LR = Channel main pan
- FX send = Disabled
- Group (Qu-24) = Channel main pan
- Mono Mix1-4 = Disabled
- Stereo Mix5-10 = Channel send pan

Pan becomes a Width control when linked for two input channels – Panning one to the left automatically pans the other by the same amount to the right.



Channel Routing screen

Adjust the channel Direct Output **Trim** from off to +10dB gain. The Direct Outputs can be patched to feed the internal FX devices, for example a delay effect send for a single vocal. They also feed the dSNAKE Monitor outputs (ME Personal Mixing System), and can be set as the CH/ST channel USB source.

The channel **source for the Direct Outputs** can be changed on this screen. This is a global setting affecting all channel direct outputs.

Typical Direct out settings:

- FX send = Post Delay, Follow fader, Follow mute
- ME Monitor = Post Comp, pre-fader, Follow mute

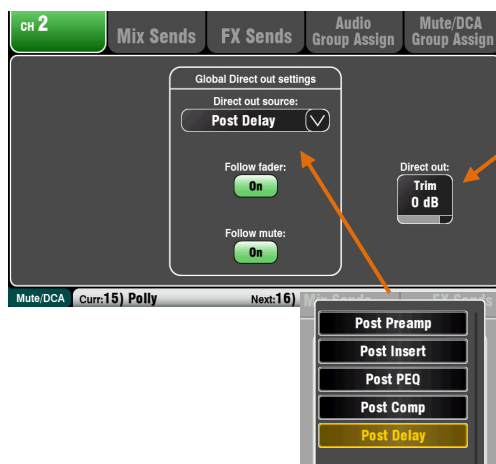



Channel Mix Sends screen

Use this screen to work with the sends and assignments from one channel to all the mixes.

Each send can be set **Pre** or **Post** fader. It is typical to set monitor sends pre-fade so that the channel fader does not affect the monitor mixes, and to set effects and fill speaker sends post-fade so that their levels do follow the faders.

The channel can be assigned (routed) **On** or **Off** to each mix. Touch the **Level** and **Pan** buttons and use the screen rotary to adjust their settings.

To work with the sends and assignments from all channels to one mix use the Master Strip **Mix** keys and the fader strips.

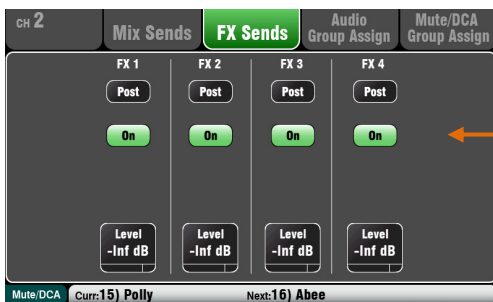

Channel FX Sends screen

Use this screen to work with the sends and assignments from one channel to the FX mixes. These are for Mix>Return effects such as reverb and delay.

The sends can be set **Pre** or **Post** fader but it is usual to leave these set post-fade so that the effects follow the channel fader level. Each send can be assigned **On** or **Off**. Its **Level** can be adjusted here.

To work with the sends and assignments from all channels to one FX mix use the Master Strip **Mix** keys and the fader strips.

Qu-16 FX3 and FX4 do not have dedicated sends. However, you can assign any of the Mix1-10 buses to feed these. To do this use the **FX / Back panel** screen.



Channel Audio Group Assign screen

The Qu-24 includes two stereo Group mixes, and the Qu-32 has four. Groups are not available on the Qu-16.

This screen lets you assign one channel to all groups.

To work with the assignments from all channels to one group use the Master Strip **Mix** keys and the Assign + fader strip **Sel** keys.

6.10 Working with the Groups (not Qu-16)

Each Group provides:

- Stereo routing
- Source Assign to Group
- Master Fader and Mute
- Output Balance
- Routing to LR and Matrix
- PEQ
- GEQ
- Compressor
- Delay
- FX insert

Mono and stereo input channels and FX returns can be routed to groups. Group routing follows the channel faders and pan. They do not have send levels.

You can use a Group to sub mix several channels for single fader level control, or to process several channels, for example:

- FX return or stereo drum sub mix
- Compressor over several backing singers
- Single EQ over several lavalier microphones
- Grouping signals for recording or ME monitoring

For sub mixing – Assign channels to the Group rather than LR, then assign the Group to LR.

Access the Group masters using the Master Strip **Mix** keys.

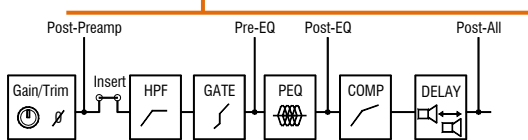
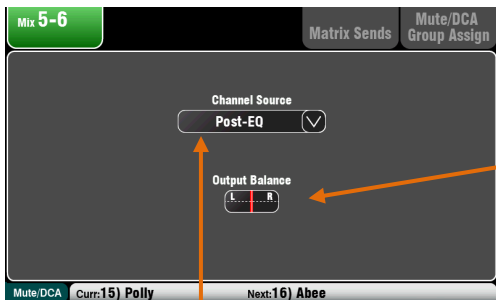

Mix Routing

Select a mix master **Sel** key while the **Routing** screen is active to:

Adjust the **Output Balance** between Left and Right of a stereo mix or LR.

Choose the global **Channel Source** for the selected mix. This is the point in the channel signal path that feeds the mix.

- Choose **Post-Preamp** if you want the sources to the mix to not be affected by any of the channel processing.
- Choose **Pre-EQ** for a monitor mix if you do not want the channel EQ to affect the monitor.
- Choose **Post-EQ** if you want the EQ but not the compressor to affect the monitor.
- Choose **Post-All** processing for FX sends.

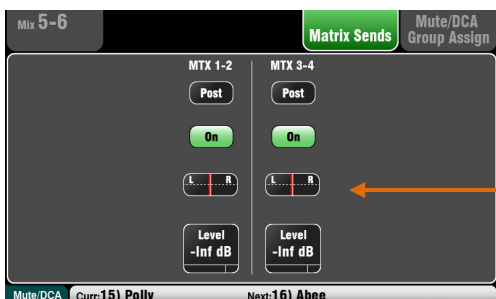

Mix to Matrix Sends (not Qu-16)

The Qu-24 and Qu-32 include two stereo Matrix mixes. These are not available on the Qu-16.

The Groups, Mixes and LR can be sent to the Matrix.

The sends to the matrix can be set **Pre** or **Post** the send master fader. Each send can be assigned **On** or **Off**. Its **Level** and **Pan** to the matrix can be adjusted here.

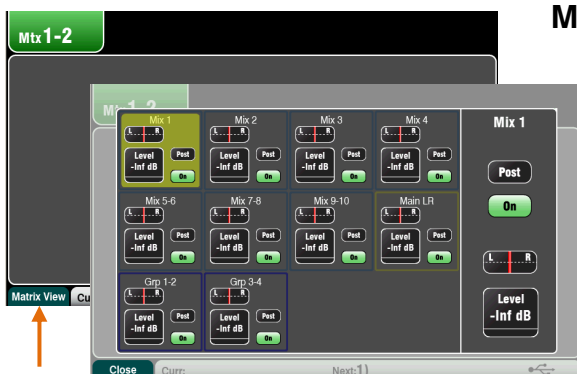

Matrix All Sends View

To work with the sends and assignments from all mixes to one matrix use the Matrix master **Routing** screen **Fn** key **Matrix View**.

Touch a mix source box. Use the right of the screen to adjust its parameters. Touch the buttons and value boxes and use the screen Rotary.

6.11 Working with the Matrix (not Qu-16)

Each Matrix provides:

- Stereo mixing
- Source send Levels, Pan and Assign
- Master Fader and Mute
- Output Balance
- PEQ
- GEQ
- Compressor
- Delay
- FX Insert

A Matrix is a 'mixer within the mixer'. Inputs route to the Groups, Mixes and LR. These can then be routed to the Matrix to provide additional outputs, for example:

- Stereo recording, video or broadcast
- Delay fill speakers

Access the Matrix masters using the top fader Layer, or assign them to the Custom Layer.

Patch the Matrix to Alt Out, AES Out and USB audio.

6.12 Mute and DCA Groups

The Qu mixer provides 4 Mute Groups and 4 DCA Groups. These let you control the levels of groups of channels or mixes.

Mute Group – Provides a single master **Mute** key to mute or unmute all channels assigned to the group. This is similar to pressing the Mute keys of all assigned channels at the same time. All channel pre-fade and post-fade sends are affected. This means that sends to FOH (LR mix), effects and monitors will all be turned off when the assigned Mute Group is muted using its master key.

Examples - Mute Groups provide a quick way to mute multiple channels during band changeovers, groups of instruments when they are not being played, or to turn off effects such as reverb when the performer is talking between songs.

DCA Groups – A DCA (Digitally Controlled Attenuator) provides remote control of the levels of the channels assigned to it. Unlike a stereo Group, audio does not pass through a DCA Group. Instead, the audio levels are controlled at the channels by information sent from the DCA master.

The DCA master **Fader** adjusts the level of assigned channels at their channel fader point and before the Pan control. This means that post-fade levels to the LR mix and effects are adjusted. Pre-fade monitor sends are not affected. The fader adjusts from fully off to +10dB boost. A channel can have a maximum +10dB boost including its own fader and control from any assigned DCA group faders. When a DCA fader is at its '0' position it has no effect on the channel levels. This is the typical starting point when working with DCA Groups.

The DCA master **Mute** key behaves the same as a Mute Group master. It affects all pre-fade and post-fade channel sends including LR, effects and monitors. DCA Mute keys can be used as additional Mute Groups simply by setting their master faders to '0'.

Examples – DCA Groups provide convenient single fader level control of multiple channels such as drums, backing vocals, stage and radio mics.

The following sources can be assigned to Mute Groups:

- Mono and stereo Input Channels
- FX Send masters
- FX Return channels
- Mixes 1-10 and LR
- Stereo Groups (not Qu-16)

Matrix masters cannot be assigned to Mute Groups.



Assigning one source to many Groups

Press the source fader strip **Sel** key and select the Touch Screen **Routing** screen.

Open the **Mute/DCA Group Assign** tab. Use this screen to assign the channel to any combination of the Mute and DCA Groups.

A green tick next to a Mute Group button indicates that its master is available on a SoftKey.



Assigning many sources to one Group

While in any **Routing** screen press the **Fn** key to open the **Mute/DCA** view.

This opens in the **Masters** tab. The master Mutes and DCA levels are accessed in this tab. There are two tabs to access the group assignments.

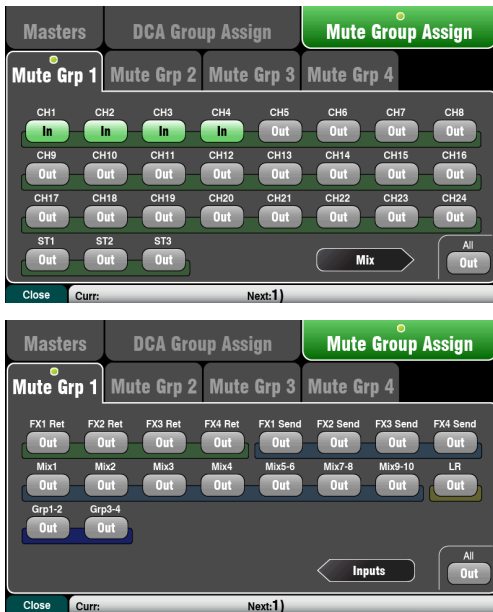

To assign Mute Groups - Select the **Mute Group Assign** tab, then touch the tab for the Mute Group you wish to assign.

To assign DCA Groups - Select the **DCA Group Assign** tab, then touch the tab for the DCA Group you wish to assign.

All sources to that group are shown. The larger Qu mixers present two pages of assignments. Touch the arrow button to navigate between the two pages.

Touch buttons to assign sources in or out of the group.

Touch the **All** button to turn all the assignments in or out. This affects assignments on both pages.

A yellow dot in the tab indicates that one or more sources are assigned within the tab.

Press the **Fn** key again to close the Mute/DCA view.

6.13 Using Mute Groups

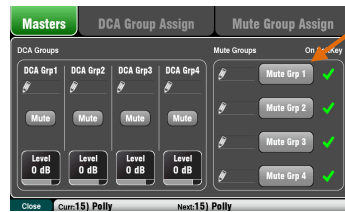
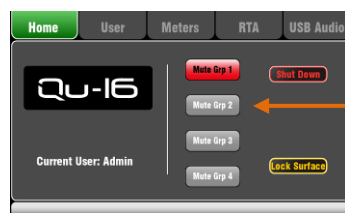

Fn key



There are 4 ways to access the Mute Groups:

1. Touch the master buttons on the **Home** screen.
2. While in any **Routing** screen, press the **Fn** key to open the **Mute/DCA** view. Touch the Mute master buttons in the **Masters** tab.
3. Assign and use one or more **SoftKeys** as Mute Group masters. Any Mute Group can be assigned to any SoftKey.
4. Use the **Qu-Pad** iPad app Mute Group strips.

The Mute key will flash red if the channel is muted by a Mute or DCA Group.

A short flash shows it is muted by the group only. A long flash shows it is muted by its Mute key and a Mute or DCA group.



6.14 Using DCA Groups

There are 5 ways to access the DCA Groups:

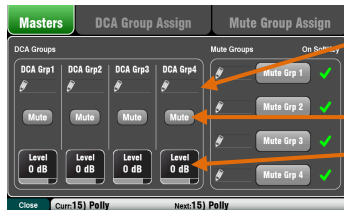

Fn key



1. All Qu mixers provide DCA master controls in the **Routing** screen **Mute/DCA** view **Masters** tab. Press the **Fn** key to open this view.

Touch a **Mute** button to mute or unmute a DCA group. Touch a **DCA Level** box and use the screen rotary to adjust its level. Its value is shown in the box.

2. The **Qu-32** provides dedicated DCA fader control strips on its Master layer. These provide direct access to the 4 DCA groups.

3. On all Qu mixers, you can assign any combination of DCA Masters to fader strips in the **Custom Layer**. Do this using the **Setup / Control / Custom Layer** screen.

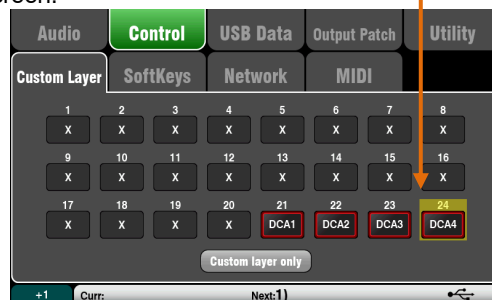

4. Assign and use one or more **SoftKeys** as DCA Group Mute keys. Any DCA Group mute can be assigned to any SoftKey.

5. Use the **Qu-Pad** iPad app DCA Group strips.

The Mute key will flash red if the channel is muted by a Mute or DCA Group.

A short flash shows it is muted by the group only. A long flash shows it is muted by its Mute key and a Mute or DCA group.

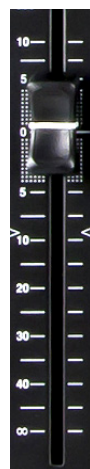

Start with the DCA Master level set to 0dB. At this setting it has no effect on the channel levels. Raise or lower the master level to adjust the post-fade levels of all sources assigned to the DCA Group.

DCA Groups can be used as **additional Mute Groups** when their masters are set to 0dB.

Note – If there is no signal when you raise a channel fader check that it has not been turned down by any DCA master assigned to it.

6.15 The Master Strip

Qu provides a dedicated fader strip for the Mix Masters. It presents the fader and controls for the mix currently selected using the **Mix** keys alongside. The sends to the selected mix are presented on the channel faders. They move to show the current settings. This provides a very quick way to access each mix without the need to switch to the Masters layer.



Mute key – Press to turn off the mix master audio signal. The Mute key lights red when the audio is muted.

Sel key (select) – Press to access the mix **Processing** (PEQ, GEQ, Compressor, Delay) and its **Routing** parameters using the SuperStrip and Touch Screen. The screen presents related parameters while its **Processing** or **Routing** key is active.

The Sel key can also be used to:

Copy mix processing – Hold down the Copy key and press the Sel key to copy the processing settings. Then select a different **Mix**, hold down the Paste key and press the Sel key to instantly paste those settings to that mix.

Reset mix processing – Hold down the Reset key and press the Sel key to instantly reset all its processing to factory default.

Assign all sources – Hold down the Assign key and press the Sel key to toggle all sources on (assigned) or off to the mix.

Set all sources Pre or Post-Fade – Hold down the Pre Fade key and press the Sel key to toggle all sources Pre or Post Fade.

PAFL key – Press to listen to a mix using headphones and check its level on the main meters. The meter PAFL indicator lights. Press PAFL again to turn it off. A SoftKey can be assigned to Clear All active PAFL selections. Options are available in the Setup screen to choose how you want PAFL to work. The default setting is **AFL** (after-fade listen).

Mix meter – The strip meter lets you keep an eye on the mix master signal level. This is 'post-fader' and displays the level after the fader and mute control to follow the signal available at the output of the mixer.

Pk – Lights red to warn that the signal is too hot and mix level should be reduced. It turns on 3dB before clipping to warn you before audible distortion.

0 – Lights when the signal reaches nominal 0dBu allowing a healthy 18dB headroom. This is the normal level for mixing.

Sig – Lights to show signal presence. It turns on at -26dBu.

Fader – Controls the level of the mix master currently selected. There is +10dB boost available. Normal setting is around the '0' position.

Mix Select keys – These select which mix master is presented on the master strip. Only one can be active at any time. Press a key to select a mix. The channel faders move to become the sends to the selected mix. Channels can be assigned using the Sel keys. Press the key again turn return to the main LR mix.

LR sets the strip to control the main LR mix. This is the normal selection for mixing the FOH (main PA) sound.

FX sets the strip to control the FX internal effects send master. The Qu-16 has 2 FX buses. The Qu-24 and Qu-32 have 4 FX buses.

Mix, Grp sets the strip to control one of the mono or stereo mix or Group masters. Groups are not available on the Qu-16.

The Mix key can also be used to **copy** or **reset** any of the FX and Mix send levels, pan and assignments. This does not affect the Pre/Post settings.

6.16 Working with the sends on faders:



Qu-16



Qu-24 and 32

- **Select a Mix** - Press a **Mix** key. The master strip presents the mix fader and controls. The channel faders move to present the sends to that mix.
- **Adjust Send levels** - For Mix and FX sends. Move the channel faders. These become the sends to the selected mix.
- **Adjust Send pans** - While a stereo Mix is selected, press a channel Sel key and use the **Pan** control to pan its send in the mix.
- **Assign sends to the mix** - Hold the Assign key to view the current channel assignments (routing) to the mix. The Sel keys light when the channel is assigned to the mix. To toggle individual assignments on or off, press channel **Sel** keys while holding Assign.
- **To toggle all assignments on or off** - Hold the Assign key and press the master strip **Sel** key.
- **Set sends Pre or Post fader** - For Mix and FX sends. Hold the Pre Fade key to view the current channel pre/post fade settings for the mix. The Sel keys light when set to Pre-fade. To toggle individual sends pre or post, press the channel **Sel** keys while holding Pre Fade. It is typical to use Pre-fade for monitor sends and Post-fade for effects sends.
- **To toggle all sources Pre or Post Fade** - Hold the Pre Fade key and press the master strip **Sel** key.
- **Group mixes** - Selecting a Grp mix lets you assign channels and FX returns to the group. The LR mix channel faders and pan positions remain active. Groups are not available on the Qu-16.
- Press the **Mix** key again or press **LR** to return to the main mix, or press another **Mix** key to adjust a different mix.

Note Always remember to return to the main LR mix once you have finished adjusting monitor or effects levels.



7. Touch Screen Mixing Functions

The Qu features an 800x480 pixel, colour touch screen for quick and intuitive setup and control of the mix. The Qu-16 and Qu-24 have 5" screens. The Qu-32 has a larger 7" screen.

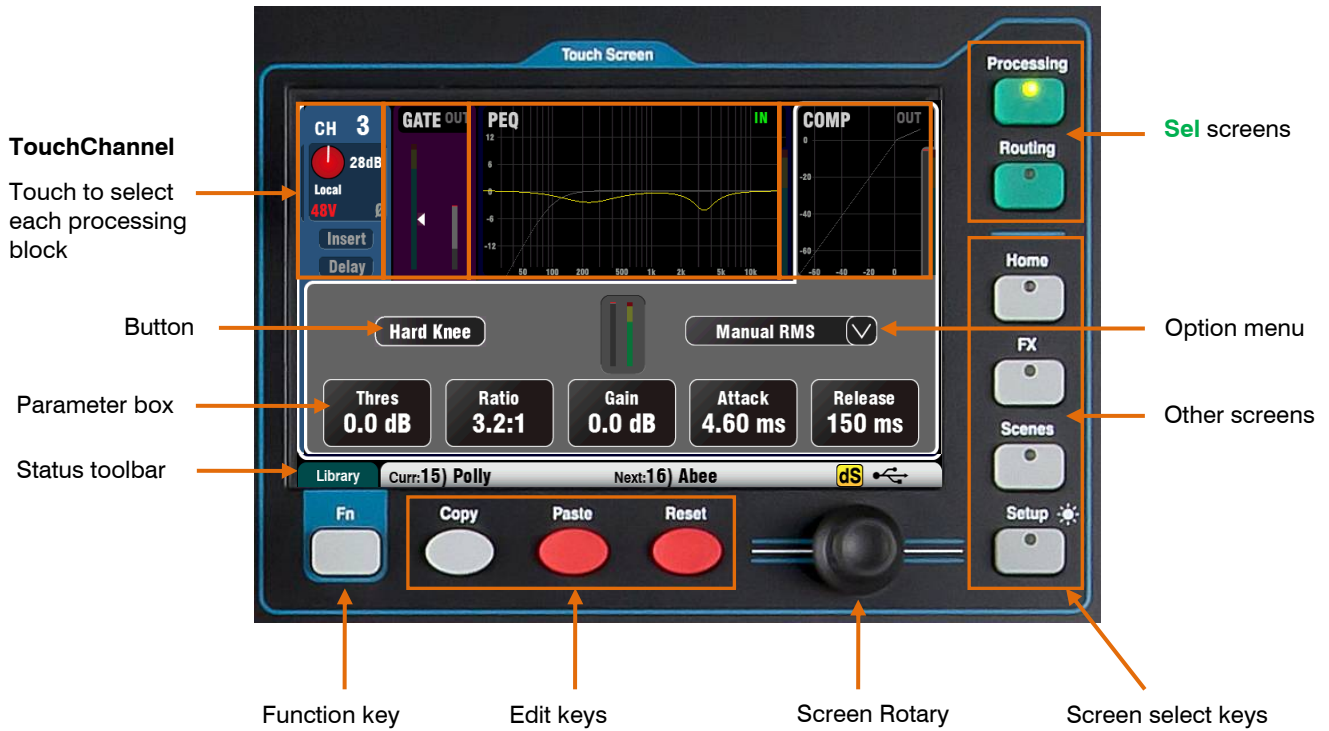

Button – Touch to select its function or change its state. Some functions need be touched for at least 1 second to avoid accidental operation, for example switching 48V phantom power or resetting the mixer. These are marked '(Hold)'.

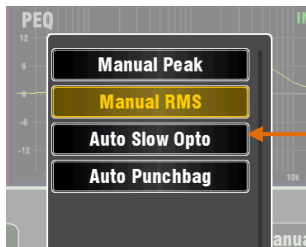

Parameter box – Touch to change its value. The box highlights orange to show it is selected and can be adjusted using the screen rotary.

Option Menu – Touch to open a list of options available. Scroll using the screen rotary and touch an item in the list to select it. Several menu lists are available within the screens, for example, to choose a compressor type.

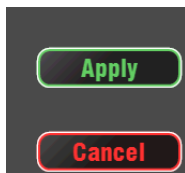

Screen Rotary – Use this to change the value of the parameter in the box highlighted orange on the screen, or to scroll through lists.

Apply / Cancel – Some setup screens present several parameters associated with one function, for example channel linking. These can be chosen before they are applied. Touch **Apply** to accept the changes or **Cancel** to close the screen without accepting the changes.

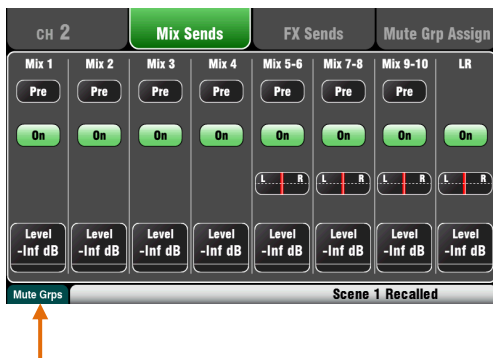

Function Key – The **Fn** key provides access to further options associated with the currently selected screen, for example channel source selection and processing libraries. It is also used to access the Mute Group and Matrix mix settings. If available, its function will appear in the lower toolbar above the key. Press the key again to close the option screen.

This example shows access to the **Mute Groups** screens from within a Routing screen.

Status Bar – This lower screen toolbar shows useful system information and is always visible.



Fn key function - for example to show that the key is available to select a Library or Options page.

Scene information – Shows the number and name of the current (**Curr:**) and next (**Next:**) scenes.



Curr: is the last scene recalled. This is blank when the mixer powers up and only appears after a scene has been recalled.

Next: is the scene highlighted in the Scenes list ready to be recalled. This information is useful when using the SoftKeys for scene recall during a theatre show.

System messages – The scene information can be overwritten by system messages, for example when using the Copy/Paste/Reset keys.



dSNAKE device status – The yellow **dS** icon appears when an AudioRack device such as the AB168, AR2412 or AR84 is connected to the dSNAKE port and is identified as powered up and operational.

Note – ME-1 personal monitor mixers can be used with the Qu mixer but are not recognised by the mixer. The **dS** icon will only appear when AudioRacks are connected.



USB status – A USB symbol appears when a compatible USB key or drive is plugged into the Qu-Drive port and is recognised by the mixer. The symbol flashes while the drive is being read. If the symbol does not appear then the USB device may need formatting using the Qu Format utility.



Qu-Drive transport status – The USB symbol is replaced with one or more icons to show the transport status of the Qu-Drive Stereo or Multitrack playback and recording.

7.1 Copy, Paste, Reset keys

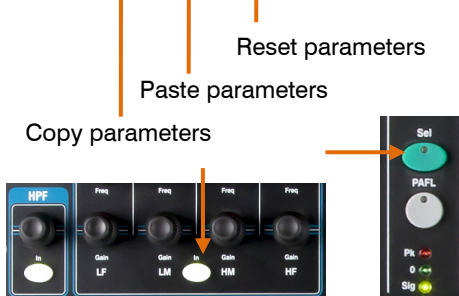

Press + hold down one of these keys and then press another key or screen item to copy, paste or reset the related parameters. For example:

Copy – Press Copy + a channel **Sel** key to select its processing to copy. Press Paste + another channel **Sel** key to paste the processing to that channel.

You can **copy just one processing block** such as PEQ using its **In** key and then paste it into other channels using their strip **Sel** keys.

Reset – Press Reset + a channel **Sel** to instantly reset its processing to factory default settings.

The following Copy/Reset is supported:

- + Input strip **Sel** key = HPF, Gate, PEQ, Comp, Delay
- + Mix strip **Sel** key = PEQ, GEQ, Comp, Delay
- + Master **Mix** key = Send levels, Pans, Assign
- + Preamp USB key = Preamp only
- + HPF **In** key = HPF only
- + PEQ **In** key = PEQ only
- + Gate **In** key = Gate only
- + Comp **In** key = Compressor only
- + Fader Flip key = GEQ
- + touch **Scene** item in list = Scene contents

Note – Copy/Reset of **Mix** does not affect the Pre/Post fader settings.

7.2 The Sel screens – Processing and Routing

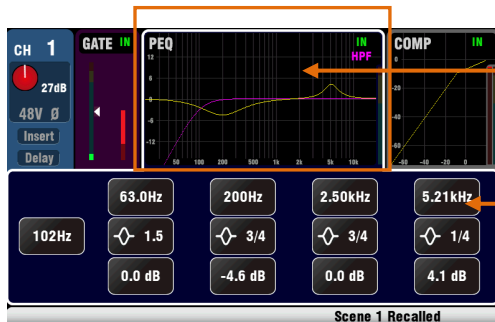

Processing Screen – When selected this screen presents the processing including Preamp, Gate, EQ, Compressor for the channel or master currently selected using its strip **Sel** key.

Touch the **top part** of the screen to select the processing block you wish to view or adjust, for example Preamp or PEQ. This section is known as the **TouchChannel**.

The **lower part** of the screen changes to provide access to the related parameters and additional related controls. Touch a parameter box and turn the screen rotary to change its value.

The physical controls in the **SuperStrip** and the touch controls in this screen provide quick access to live mixing functions.



Routing Screen – When selected this screen lets you access the assignment and routing for the channel or master currently selected using its strip **Sel** key.

This lets you work with routing to all mixes from one channel. To work with all channels to one mix use the Master Strip **Mix** keys and sends on faders.

The **Fn** key provides access to the Mute Group masters and assignments.

7.3 Home Screen



Press the **Home** key. Pressing it again restores the last selected **Sel** screen. The Home tab presents:

- Current Firmware version
- Current User
- The 4 Mute Group master buttons
- **Shut Down** button to safely shut down the mixer before turning power off
- **Lock Surface** to protect settings when the mixer is left unattended

7.4 Home Screen – User

Three User Profiles are available to protect selected functions and restrict user access, for example for volunteer operators in houses of worship, or guest engineers visiting venues. The Admin user has access to all functions and can set permissions and allocate passwords if required for the other users.



This screen lets you log in as one of 3 Users with different permissions:

- **Admin** – Full access to all functions. This is the factory default and normal setting when User Profiles are not needed. Admin can set the passwords and permissions for the other users.
- **Standard** – Operation only. The user is locked out of setup. Admin configures the channel/mix access, layout, patching and scene range to be allowed for the day-to-day or guest operator.
- **Basic** – Faders and mutes only. This is for very simple level control. Admin can set access to none or a range of scenes for recall only.

Touch a User button to select a User Profile to edit or log in.

The Admin user can press the **Fn** key to open the **Permissions** page.



Touch the **Password** box to enter a Password.

You can assign a **User Scene** to recall automatically when the User logs in. This recalls when the User is changed, not when the same user logs back in after power up.

You can restrict Standard or Basic user access to a limited **Scene Range**.

Touch to log in as a different user. Enter the password if one is set.

Access to mixes

Allow or block access to the **Mix** key Pre/Post and routing assignment.

Block access to the **Sel** key Routing screens.

Choose which mixes can be accessed using the **Mix** Select keys.

Allow or prevent the user being able to record the mix using **Qu-Drive**.

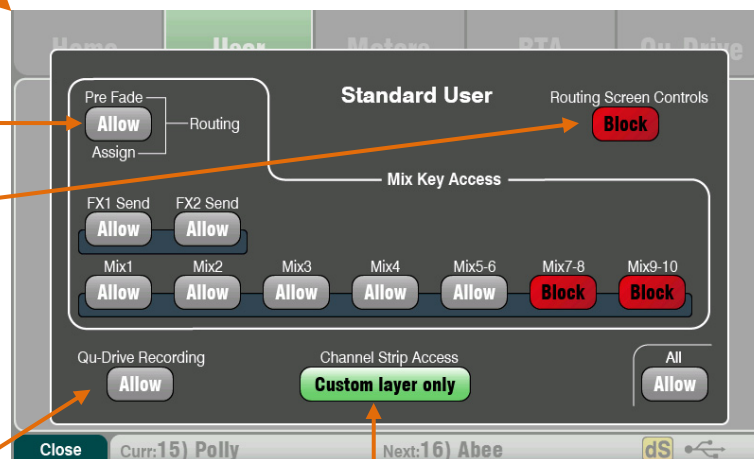

The **Basic User** is given access to fader and mute control of the LR mix only. They can recall scenes if a Scene Range has been set.

The **Standard User** does not have access to any Setup functions and can be blocked from certain mixes and routing control. They have full access to scenes within the specified range.

Custom Layer Only can be set to lock the user out of the standard Inputs and Masters fader layers. Admin can assign just the required channel strips and therefore prevent the user accessing channels that should not be touched.

This is a powerful tool in customising the Qu mixer to suit the intended user and application.

7.5 Home Screen – Meters

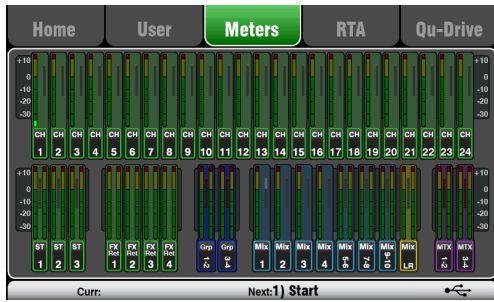

This screen provides a convenient view of all channel, mix and FX signal activity.

For optimum performance the loudest signals should read into the yellow. If any red Peak meter flashes then reduce the level of that signal to avoid possible distortion. Increase levels if the meter readings are consistently low.

The Qu-24 meters screen is shown here. Qu-32 provides two pages of meters. The Qu-16 does not include Group and Matrix meters.

7.6 Home Screen – RTA

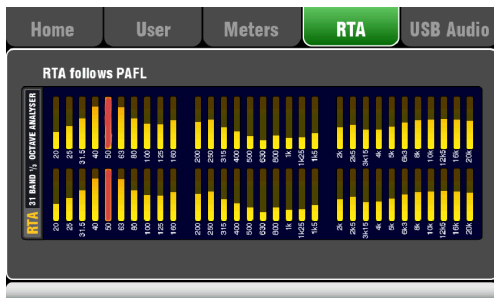

This screen displays a Real Time Analyser (RTA) which analyses the frequency content of the audio signal currently being monitored using the PAFL keys.

It splits the frequency into 31 third octave bands from low 20Hz to high 20kHz, the same frequencies as used on a graphic equaliser. The dominant 'Peak Band' frequency displays in red.

The RTA is a useful tool to help you identify problem frequencies such as room resonance and feedback.

The iPad **Qu-Pad** app can also show a display of the RTA peak band (most dominant frequency).

7.7 Home Screen – Qu-Drive (USB audio)

Note – Qu-Drive audio recording and multitrack playback require the USB storage device to support high sustained transfer rates. Not all USB devices will guarantee flawless performance. To find out more please refer to the 'Understanding Qu-Drive and USB' document in the Qu Knowledgebase on the Allen & Heath web site.

This opens screens associated with the USB stereo and multitrack recording:

Note - Use the USB storage device with the Qu mixer only. Do not use it for other applications.

* **Format the hard drive** on the Qu mixer before starting to record. Use the **Setup / Utility / Qu-Drive** screen. This clears the drive and sets up the Qu directory structure.

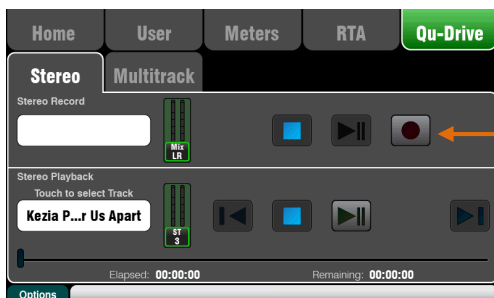

Qu-Drive Stereo page – This screen presents the controls for stereo recording to and playback from a USB device plugged into the top panel Qu-Drive port.

The blue Stop buttons light if the USB device is recognised by the mixer. The controls are disabled if a USB device is not plugged in or recognised.



Stereo Record – You can record to a USB storage device plugged into Qu-Drive:

- Format = 48kHz, 24-bit, WAV file
- Data rate = 288 KB/sec, maximum 4 hours (4GB)
- Qu allocates a file name 'QU-STnnn.WAV' where 'nnn' increments from 001 to 999 starting at the highest number + 1 it finds on the USB device.

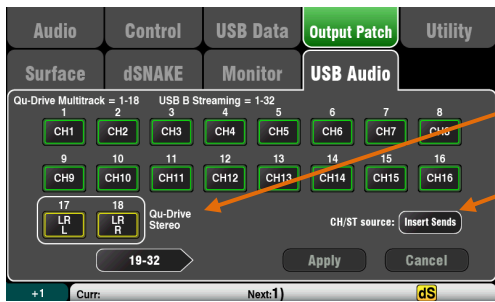

Patch the source to be recorded using the **Setup / Output Patch / USB Audio** screen. Touch the track 17 box and turn the rotary to select the left source. Press the '+ 1' **Fn** key to increment the right source to track 18, or use the rotary to select an unrelated source.

Mono or stereo Channels and Groups can be globally sourced from their Insert Sends (pre-processing) or from Direct Out using this button.

Note Qu-Drive Stereo recording shares the same patch as Track 17-18 of the Qu-Drive multitrack recording and USB streaming.

The record meter on the USB page displays the current source. The default is LR post-fade.

Arm the recording by touching the red circle Record button. Touch the Play button to start the recording.



Recording Errors - A warning message displays if buffer overrun errors are detected during recording. Try reformatting or using a different USB drive.

Stereo Playback – You can play back audio files from a USB storage device plugged into Qu-Drive:

- Format = 44.1 or 48kHz, 16 or 24-bit, WAV file

Note – Use the USB device with the Qu mixer only. Do not use it for other applications.

Format the USB device on the Qu mixer before loading the playback files. Use the **Setup / Utility / Qu-Drive** screen. This clears the drive and sets up the Qu directory structure.

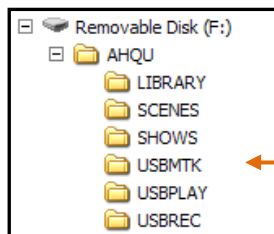

Copy audio WAV files on to USB from your computer. Place these in the AHQU / USBPLAY directory. Plug the USB device into Qu-Drive.

Patch the playback to the ST3 channel using the **Processing / Preamp** screen **Fn** key to open the Preamp Source screen. Make sure Qu-Drive is selected as the 'Global USB Source'. Select USB as the source for ST3.

Once you have selected Qu-Drive as the global USB source you can also use the panel **USB** key in the Preamp section to toggle between the ST3 preamp and USB source.

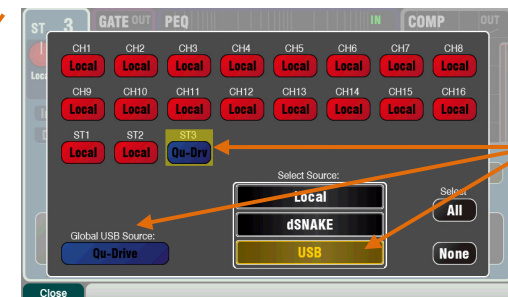

Select the track to play back by touching the name box. You can choose a track from the Playback or the Recordings directory. Touch **Select** to confirm.

Press the Fn key for options to choose playback mode:

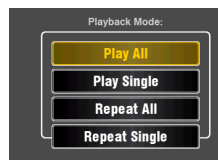
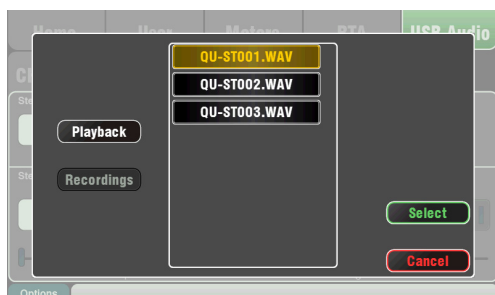

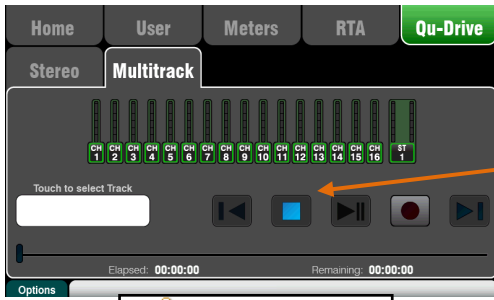

Qu-Drive Multitrack page – This screen presents the controls for multitrack recording to and playback from a USB storage device plugged into the top panel Qu-Drive port.

The blue Stop button lights if the USB device is recognised by the mixer. The controls are disabled if not plugged in or recognised.

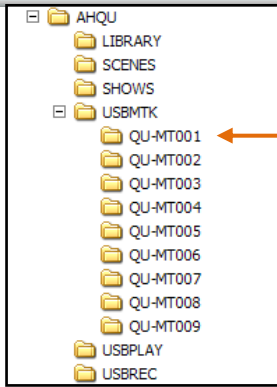

Multitrack Record – You can record to a USB storage device plugged into Qu-Drive:

- 18 Tracks = Individually patchable sources
- Record format = 48kHz, 24-bit, WAV file
- Data rate = 144 KB/sec per track (max 4GB total)
- Qu allocates a folder name 'QU-MTnnn' for each recording where 'nnn' increments from 001 to 999 starting at the highest number + 1 it finds on the device. The tracks are named 'TRKnn' within the folder where 'nn' is 01 to 18.

Note – We recommend you transfer previous recordings to your computer and then reformat the USB device on the Qu mixer before using it for each show. This will avoid potential audio skipping that may occur with some USB devices containing long recordings.

Note – Use the USB storage device with the Qu mixer only. Do not use it for other applications.

Format the USB device on the Qu mixer before starting to record. Use the **Setup / Utility / Qu-Drive** screen. This clears the USB and sets up the Qu directory structure.

Patch the sources to be recorded using the **Setup / Output Patch / USB Audio** screen.



Touch a track box and turn the rotary to select the source. Press the '+1' **Fn** key to increment the assignments. Choose the global source for CH and ST channels and the Audio Groups.

Arm the recording by touching the red circle Record button. Touch the Play button to start the recording.

Multitrack Playback – You can play back your multitrack recordings from the USB device plugged into the Qu-Drive port:

Patch the playback to the input channels using the **Processing / Preamp** screen **Fn** key to open the Preamp Source screen. Make sure Qu-Drive is selected as the 'Global USB Source'. Select USB as the source for the channels you wish to play back.

Select the recording to play back by touching the name box. You can choose a folder from the list. Touch **Select** to confirm.

Press the Fn key for options to choose playback mode:



Note – Qu always expects 18 tracks to be present in the multitrack folder. -You can create dummy tracks by duplicating and renaming your files.

Note – Choose to play back either Qu-Drive stereo or multitrack. It is not possible to play back both stereo and multitrack at the same time.

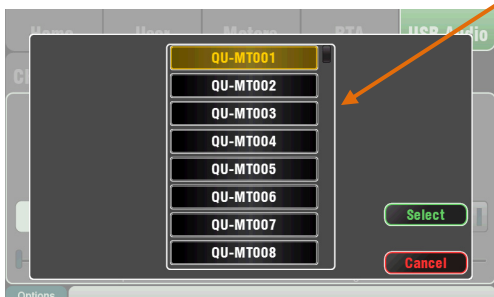
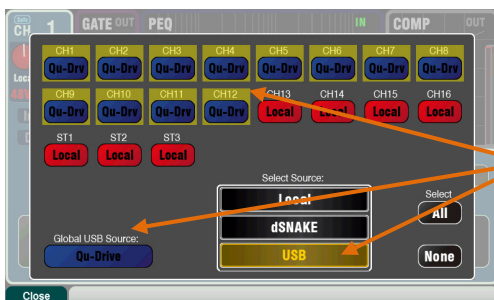

7.8 The FX

Qu features 4 internal stereo FX (effects) processors. Each can be loaded from a library of different effects types and presets. These are the same as found in the flagship Allen & Heath iLive digital mix system and are based on emulations of popular industry standard effects.

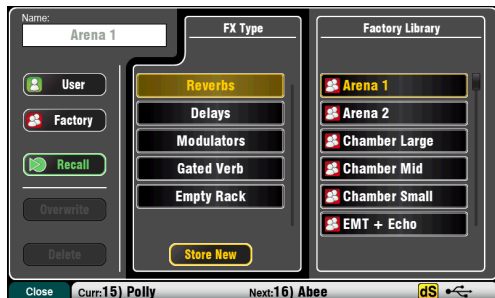

Front Panel view

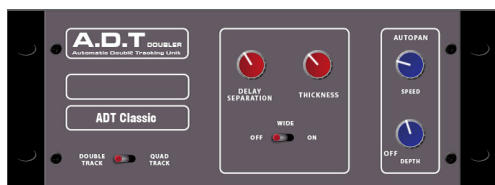
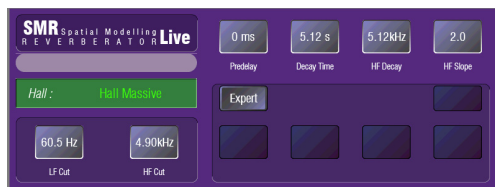

The FX screen

Press the FX key next to the Touch Screen to open the FX screen. You work with the FX in the same way you would with a traditional outboard rack. Start with an empty rack as shown here. Each of the 4 FX has a rack slot. Touch the tabs at the top to select each slot.

Library – Press the **Fn** key to open the Library page. Select Factory or User library and scroll through and select the FX type you wish to load into the rack. The effects are arranged in types on the left with available presets for each in the right hand window. Touch Recall to load the FX.

Listen to and experiment with the different presets and their parameters available.

FX types

Reverb – This is the most popular effect in live sound mixing. The SMR Live (Spatial Modelling Reverberator) features 4 fully configurable spatial models - Classic, Hall, Room and EMT plate. Each of these use different reflection and decay algorithms to add natural sounding space to the dry signal whether subtle small room echo, vintage vocal plate or a massive arena. Reverb can make a vocal sound spacious and smooth in the mix or add body to an instrument such as acoustic guitar or flute. There are plenty of factory presets available. The 4 buttons at the top control the main parameters if you wish to make adjustments. HF and LF cut shape the response, and Expert opens up a host of parameters for fine control if you wish to experiment further. You also have the 4-band PEQ available in the FX Return channel processing.

Delay – Generates separate left and right tap delay outputs from the input. Delay time can be dialled in using the screen rotary, tapped on screen or tapped using a SoftKey. The left and right delay taps can be linked to produce a mono effect. Feedback adds regeneration for a repeating echo effect. Set a short delay time around 80 to 160ms for the classic slapback effect.

ADT - An Automatic Double Tracking module capable of creating short echo/chorus, classic double tracking and 'slapback' tape delay loops. It includes a stereo width enhancer and auto panning within the stereo field. The ADT is perfect for creating classic doubling effects, thickening programme on stage or developing a stereo sound field as an alternative to chorus.

Chorus - Chorus derives from the late 80's where different stereo field creation techniques influenced the sound of each chorus unit. Chorus recreates the classics using 3 stereo-field emulations. These emulations can be switched in any combination creating many different stereo fields.

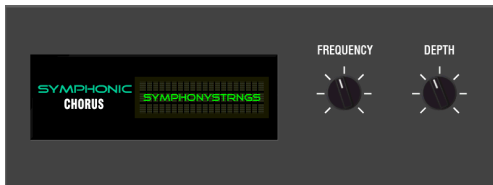

Symphonic Chorus - A faithful emulation of the 80's classic chorus effect. Simple to use and frequently requested. The unit has just two controls, Frequency and Depth controlling the rate and delay range of the stereo modulator. The unit produces a rich, lively and wide chorus sound with a suggestion of very mild phasing / flanging. Live engineers commonly use this for thickening vocals and strings and creating a spatial sound from a mono source. This has led to two factory presets 'SymphonicVox' and 'SymphonyStrings'.



Flanger – Qu provides three classic flanger effect emulations – 'Ambient', 'Vintage' and 'Wild'. During research of classic pedal flangers we found numerous LFO modulators and stereo splitting techniques. We implemented them all. For classic deep flange set Stereo Split and Stereo Spread off, pick triangular modulation, Vintage type and adjust Depth and Regeneration.

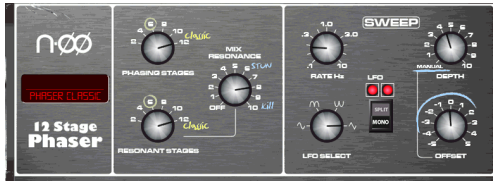

Phaser - A classic 12 stage emulation producing rich textured phasing with plenty of control. You can control the number of stages, feed forward and feedback, and 'zero' depth manual mode to manually sweep the Phaser using the offset control.



Gated Verb- An accurate emulation of the popular 80's Gated Reverb plus two other variants called 'Panned' and 'Powerbox'. The user interface gives instant access to Lo-cut Hi-cut decay spectrum filters and the gate envelope controls - pre-delay, attack, hold and release.

Back Panel view

Patching the FX

Touch the top right tab to select the Back Panel view. Open the option list to select the type of FX patching. Touch **Apply** to confirm any changes:

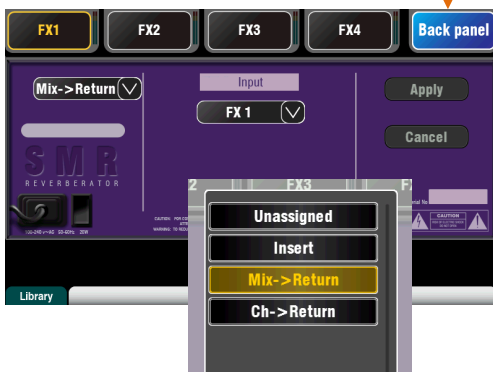

- **Mix>Return** – Known as a 'system effect' this uses a bus to Send a mix of the channels to the effect, and a dedicated stereo FX Return channel to add the 'wet' effect to the 'dry' original sound. This is used for effects such as reverb and delay. Choose which mix bus to use as its input. For the Qu-16, FX1 and FX2 have dedicated buses. If you want to use FX3 or FX4 as another system effect you could patch one of the Mix1-10 buses as its input.



- **Ch>Return** – This is similar to a Mix>Return system effect but fed from one channel rather than a mix of channels. It uses the assigned input channel Direct Output as its source. Examples include a vocal channel delay, gated verb on a snare, or chorus added to guitar.

- **Insert** – Here the effect is patched in line with an input channel or mix master. It is switched in or out using the channel Insert switch. Inserted FX provide a Dry/Wet control to balance the effect with the original signal.

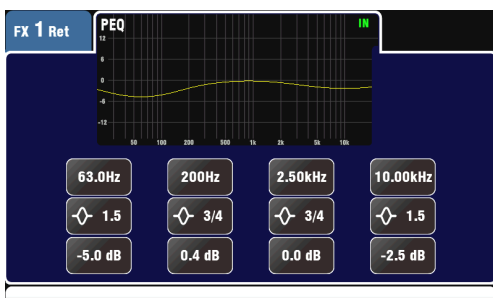

FX processing view

Press an FX Send or Return strip **Sel** key while the **Processing** screen is active to view and work with its parameters. Touch the top of the screen to open the PEQ view and adjust its return channel equaliser.

7.9 Working with FX – Adding vocal reverb:



- Press the FX key to open the **FX** screen. Touch to select FX1. Press the **Fn** key to open the Library page. Touch 'Factory'. Recall a Reverb into the FX1 slot if one is not already loaded. Open the Back Panel view and check that FX1 is set for Mix>Return with FX1 as its input.

- Start by turning up a vocal channel fader while the master strip **LR** mix is selected to hear the signal in the main PA mix.

- Select the top layer to view the FX Return channel strips. Set these faders to their '0' position and check they are unmuted to ensure the effect signals will be returned to the main mix.



- Press the **FX1** Mix key. The master strip now presents the FX1 Send master fader and controls. The channel faders move to show the sends to FX1.

Sends on faders



- Press the master strip **Sel** key to view the FX1 parameters on the screen. Press the **Fn** key to access the library.
- Set the master strip fader to its '0' position and check that it is unmuted to ensure the channel sends will be sent to the FX.
- Move the vocal channel fader to adjust its **send level** to the selected FX. This is similar to turning an Aux send knob on an analogue mixer to feed an outboard effects unit.
- You should now hear the reverb added to the dry vocal signal. Adjust the send fader for the amount of reverb you want. You can also send other channels to the reverb by turning up their send faders, for example backing vocals and instruments.
- When done, remember to return the faders to the main mix by turning off the **FX1** Mix key or selecting the **LR** key.
- You can assign the FX sends or returns to a **Mute Group** if you want to be able to turn off all the effects with a single key, for example between songs.
- You can assign a SoftKey as a **tap tempo key** for a delay effect. This lets you quickly tap in the beat for a vocal delay without the need to open the FX screen.

Use the **FX Library** to recall different effects types and presets, or to store your own parameter settings as User presets. Listen to their effect on different signals and experiment with their levels and settings so that you can use them as a creative tool while mixing.

7.10 Scene Memories

Qu provides 100 Scene memories. These store and recall a snapshot of all live mixing parameters. Scenes have many applications. They can be used to store settings for bands during sound check for recall before they take to the stage during the show. Scenes can also be used for cue recall during theatre shows, or to provide a known starting point for different events or users in a multi-purpose venue.

The Scenes screen – Press the **Scenes** key next to the touch screen.

Scene list - Scroll through scenes in the list.

The number available depends on the range allowed for the current User.

Touch to highlight a scene ready to store, recall or edit.

A green tick shows that a scene has contents stored.

Hold the **Copy** key and touch a scene in the list to copy its name and contents. Hold Paste and touch other scenes to paste it to other locations.

Global Filter – Opens a tab where you can ‘block’ combinations of parameters so that they are not overwritten when any scene is recalled. This filter affects all scenes.

A red dot **●** displays when one or more parameters are blocked.

Safes – Opens a tab where you can make combinations of input and mix channels ‘safe’ so that none of their parameters are overwritten when any scene is recalled.

A blue dot **●** displays when one or more channels have been made safe.

Name – Touch to open the screen keypad to edit the scene name with up to 14 characters. Entering a name for a blank scene will automatically store its contents.



Recall – Touch to recall the scene highlighted in the list.

Store – Touch to store the current settings to the scene highlighted in the list.

Note - Stored contents are not affected by the Filter. All current settings are stored. The filter blocks parameters on recall only.

Per Scene Filter – Each scene has its own Recall Filter. Touch to open its Filter page. You can block combinations of parameters so that they are not overwritten when the scene is recalled.

A red dot **●** displays if one or more parameters are blocked by the Filter.

Hold the **Copy** key and touch a Filter button to copy its settings. Hold Paste and touch other Filter buttons to paste those settings into other filters.

Hold the **Reset** key and touch Filter buttons to clear all their blocked parameters.

Clear – Touch to clear the name and contents of the highlighted scene. This also clears the filter

Toolbar – The last recalled (Curr:) and highlighted (Next:) scenes are shown in the lower toolbar.

Reset Mix Settings – This provides a quick way to ‘Zero the board’ by resetting the mix and processing to a typical starting point. To avoid accidental operation the button must be touched for 1 second or more to action the reset.

Note – Reset Mix Settings affects all scene settings and is not affected by the Global Recall Filter.

Note – Reset Mix Settings restores the Local preamps as the source to input channels.

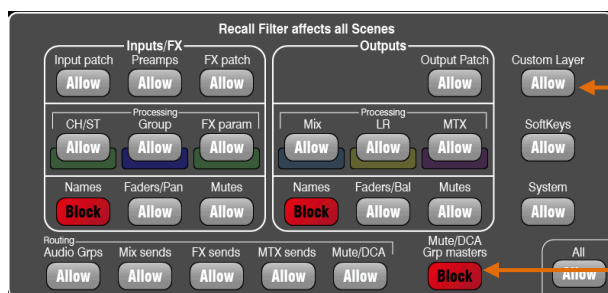

Allowed parameters – These are overwritten with the contents stored in the scene when it is recalled.

Blocked parameters – These are not overwritten when the scene is recalled.

Close the Filter page using the **Fn** key.

A **Scene** stores the following:

- Preamp settings
- Channel processing and linking
- Channel patch and routing
- Channel sends
- Channel mutes
- Channel faders/pan
- Mix processing
- Mix mutes
- Mix faders
- FX parameters
- Output patch
- Talkback assign and filter
- Mute Groups
- DCA Groups
- Custom strip assign
- SoftKey assign

A Scene does not store:

- PAFL settings
- Signal generator settings
- USB record/playback settings
- Scene preferences
- User profile settings
- Network and MIDI settings
- 'Custom Layer Only' option

Scene contents

A **Scene** is a 'snapshot' of the Qu mixer settings. It stores the current layout and patch, and parameters associated with live mixing. It does not store user configuration, setup preferences and functions not typically needed for live show recall.

Use the **USB Show** file function if you wish to archive the full Qu configuration and Scene/Library memories.



To Copy a Scene – Press and hold the Copy key below the screen and then touch the scene to copy. Now press and hold the Paste key and touch the scene in the list to paste to. This copies the scene contents and name.

The Safes screen

A **Recall Safe** protects all parameters for one channel.

Scene recall affects all input channels, FX and mixes. You can make one or more of these 'Scene Safe' so that none of their parameters are overwritten by any of the 100 scenes. For example, walk-in music and continuity microphone channels.

A blue dot  appears in the tab if one or more channels have been made safe.

Input Safes – Make any combination of the sources to the mixes safe – CH, ST1-3, FX Returns. Protects:

- Channel processing,
- Channel fader and pan
- Routing and sends to all the mixes
- Mute and DCA Group assignments

Mix Safes – Make any combination of the mixes safe – Mix1-10, FX Sends1-2, LR. The Qu-24 includes Safes for its Groups and Matrix mixes. Protects:

- Master processing,
- Master fader and balance
- Routing and sends from the channels
- Global channel send source
- Mute and DCA Group assignments



Filter parameters:

Inputs/FX (All CH, ST, FX Ret, Groups)

- Input patch (Local, dSNAKE, USB)
- Preamps (Gain/Pad/Trim/48V/Pol)
- CH/ST process (Gate/PEQ/Comp/Dly)
- Group processing (not Qu-16)
- FX patch
- FX parameters
- Inputs/FX/Group Faders/Pan
- Inputs/FX/Group Mutes
- Inputs/FX/Group Names

Outputs (All FX Sends, Mix, LR, Matrix)

- Input patch
- Output patch (Sockets, Qu-Drive)
- Mix process (PEQ/GEQ/Comp/Dly)
- LR process (PEQ/GEQ/Comp/Dly)
- Matrix processing (not Qu-16)
- Master Faders
- Master Mutes
- Master Names

Routing

- Audio Groups (Assign)
- Mix sends (Lev/Pan/Assign/Pre)
- FX sends (Lev/Assign/Pre)
- Matrix sends (Qu-24 only)
- Mute/DCA Groups (Assign)

Other

- Mute/DCA Group Masters and Names
- Custom Layer (Assign)
- SoftKeys (Assign)
- System (Talkback assign/HPF)

The Filter screen

A **Recall Filter** protects one or more parameter types for all channels.

A scene stores all live mixing parameters. A Recall Filter can be set to protect (block) chosen parameters from being overwritten when the scene is recalled.

Each scene has its own filter. You can choose to recall as many or as few parameters as you want for each scene. For example, you could recall just fader levels and mutes for a range of cues in a theatre show.

The Global Filter protects parameters from being overwritten by any of the 100 scenes.

A red dot  appears in the tab if one or more items have been blocked.

Filter parameters are grouped according to type and association with inputs or outputs.

Note - The Qu-16 does not include Audio Groups and Matrix outputs. Their associated parameters are not included in its filter.

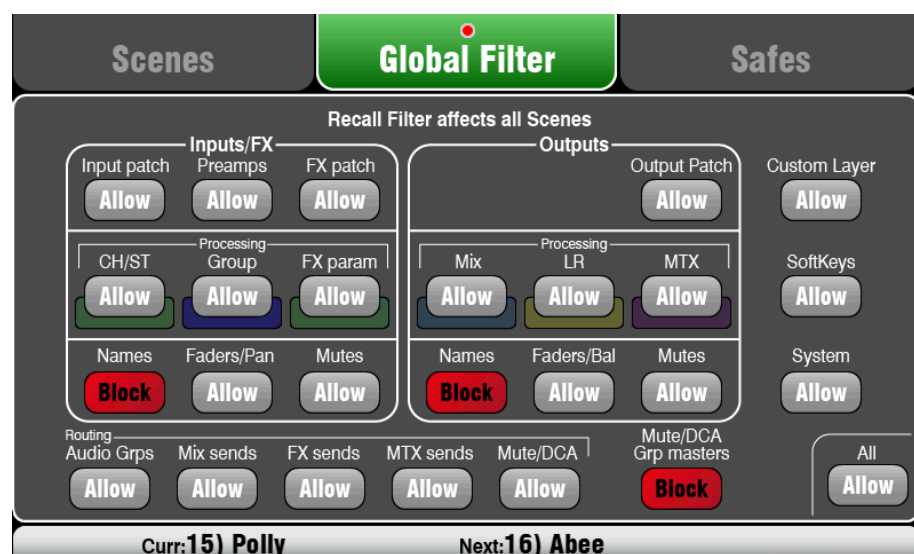

8. Touch Screen Setup Functions

Press the Setup key next to the Touch Screen to open the **Setup** screens.



Touch the top tabs to access the different categories of setup function. Touch the tabs below to open up the related options available.

Dimmer – Hold down the Setup key and turn the screen rotary to adjust the screen and surface LED brightness.

The Qu mixer always powers up with full brightness.

8.1 Audio Setup -PAFL

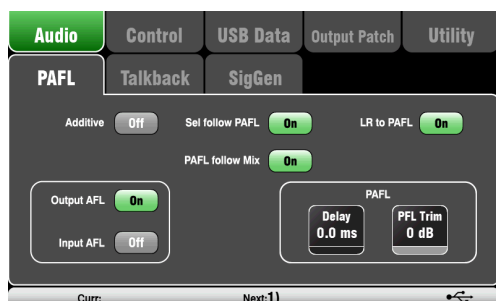

Choose how you want PAFL to work:

Additive mode – Select to listen to more than one channel at a time. Pressing a PAFL key adds to the previous selection. When off, the mode is Auto-cancel to listen to one channel at a time where pressing a PAFL key cancels the previous selection.

Input/Output PFL (pre-fade listen) – Monitor the signal before the fader, for example to check it and set its gain before you bring up the fader. This is the default.

Input/Output AFL (after-fade listen) – Monitor the signal in stereo after the fader and pan so that you can hear its contribution and position in the LR mix.

Sel follow PAFL – Link the Sel switch so that pressing PAFL automatically selects the processing for that channel.

PAFL follow Mix – When turned on, PAFL will follow the active Mix selected using the Master strip Mix keys. This applies only if PAFL is first selected using the Master strip PAFL key. Default for this option is On.

LR to PAFL – Routes the main LR mix to the monitor when there is no PAFL selected.

PAFL Delay – Delay the monitor to time align it with the acoustic sound from the source when the mixer is a long distance away from the stage. Start with 1 ms per foot.

PAFL Trim – Attenuate the PFL (pre-fade) signal by up to 24dB to match it with the average AFL (after-fade) signal which is often much lower than PFL.



8.2 Audio Setup - Talkback



Set up and assign Talkback to talk to the musicians via their monitors, or make announcements via the house (PA) mix:

HPF – Dial in the High Pass Filter to remove low frequency pops and resonance while talking. Factory default is 120Hz.

48V – Hold for 1 second to switch on phantom power.

Gain – Adjust the talkback mic level.

Assign – Touch to toggle the assignments to the different mixes on or off.

Press the surface **Talk** key to talk to the musicians or house. Active Talk is indicated by the green **[T]** icon in the lower toolbar.

Momentary Latch option - Press the **Fn** key to open the **Options** screen to access the Talk option:

Option Off = The Talk key is momentary action only. Press and hold to talk.

Option On = The Talk key latches on or off when you press it quickly. It becomes momentary when you press and hold it for longer than 0.5 second.

Select this option when you are working with a switched talkback microphone and therefore want Talk to be permanently selected.



8.3 Audio Setup –Signal Generator



Set up and assign the Signal Generator to test loudspeakers and align levels between equipment.

Source – Touch to open the list of sources available:

- Sine – Pure tone with adjustable frequency. Set to 1kHz and use meters to match equipment levels.
- White Noise – Equal energy per Hz.
- Pink Noise – Filtered white noise for equal energy per octave. This is a good source to use for testing loudspeaker drivers and phase. Its response matches the way we hear frequencies.
- Band-pass Noise – Pink noise filtered around a frequency which can be swept from low to high.

Level – Start with the level set low to avoid unexpected loud sounds when you assign to the mixes.

Mute – Turns the signal off.

Assign – Touch to toggle the assignments to the LR and Mixes 1-10 on or off. Assignment to the Groups and Matrix is not available on the Qu-16.

Note – To avoid noise in the system remember to turn the assignments off when you have finished using the generator.

8.4 Control Setup – Custom Layer



The Custom Layer can have any combination of channel, FX , master and MIDI strips assigned to its faders. Faders can be left unassigned.

This lets you arrange the faders you are using for your show into one convenient layer, or use the Custom Layer to control your Digital Audio Workstation (DAW).

The screen presents an **assignment button** for each fader. Touch a button and then turn the screen Rotary to scroll through the available strips.

Use the **Fn** key '+ 1' function to quickly assign strips in sequence.

The following strip types are available:

X	Unassigned
CH	Mono input channels
ST	Stereo input channels
FX Ret	FX returns
FX Send	FX sends
Mix	Mix masters 1-10
LR	Main LR master
Grp	Stereo Groups (not Qu-16)
MTX	Stereo Matrix (not Qu-16)
DCA	DCA Group master
MIDI	MIDI DAW control

DAW control – When working with a DAW (Digital Audio Workstation) it is typical to assign all faders as MIDI strips so that the Custom Layer can be used to control the audio tracks within the DAW.

Touch button 1, turn the rotary until it displays 'MIDI', then press **Fn** key '+ 1' to quickly assign the other strips for DAW control.



To select the Custom Layer
press both Layer keys together.

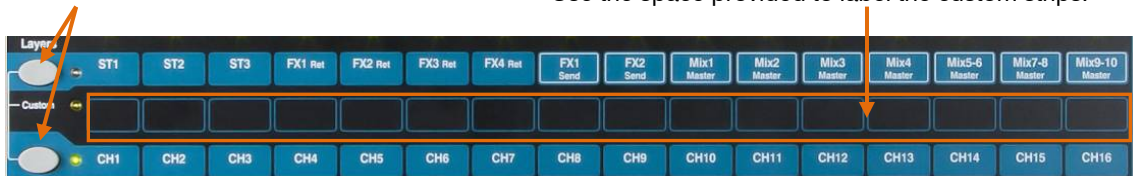

Turn on the **'Custom layer only'** option if you want to lock out the two standard layers and let the operator work with just the Custom layer.

Use the space provided to label the custom strips.

8.5 Control Setup - SoftKeys

Qu-24 shown

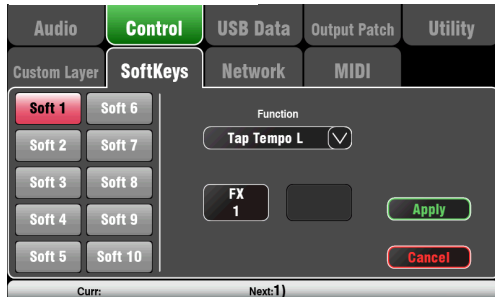

Qu-16 provides 4 SoftKeys. The Qu-24 and Qu-32 provide 10 SoftKeys. These are called 'Soft' because they can be assigned to different functions by the user.

Function – Touch the box to open and choose from the list of available functions. Touch **Apply** to confirm the changes.

Note - SoftKey settings are stored in scenes. If you do not want these settings overwritten when scenes are recalled then block the 'SoftKeys' item in the Global Filter. Use the **Scenes / Global Filter** screen.

Unassigned – The SoftKey does nothing.

Mute Group – Becomes the Mute master for the assigned Mute Group. This is the factory default setting for SoftKeys 1-4.

DCA Mute – Becomes the Mute key for the assigned DCA Group. You could use these as extra Mute Groups if you set the DCA master level to 0dB.

Tap Tempo – Use the SoftKey to tap in the time setting for Delay FX. Choose L, R or L+R (both to follow the same tap).

Recall Scene – Instantly recalls the scene number assigned to the SoftKey.

Scene Store Current – Instantly stores the current mixer settings to the last recalled scene. This is shown in the 'Curr:' bar.

Scene Recall Go – Instantly recalls the Scene shown in the 'Next:' bar.

Scene Next – Advances to the next scene in the list.

Scene Previous – Steps back to the previous scene.

PAFL Clear – Set a SoftKey to clear any active PAFL keys. The SoftKey lights to show when a PAFL is currently selected.

Qu-Drive – Set SoftKeys as transport controls for stereo and multitrack recording and playback. Touch and scroll using the rotary to select the transport control required.

MMC – Set SoftKeys as transport controls for MIDI.

DAW Bank Control – Set SoftKeys as DAW Bank up/down controls.

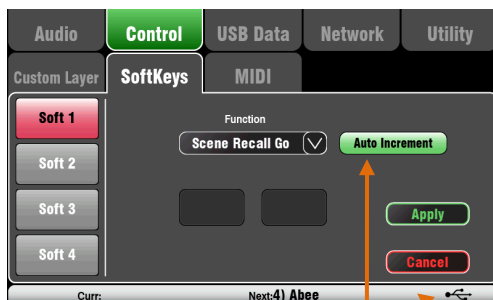

Set Auto Increment if you want to step through your scenes using a single key. This recalls a scene, then advances to the next available scene ready to recall it when the key is pressed again. For example, step through your cues in a theatre show. Auto-increment skips blank scenes.

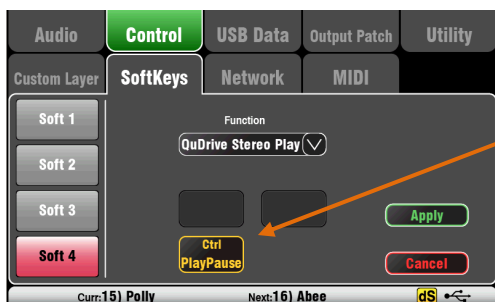

8.6 Control Setup - Network

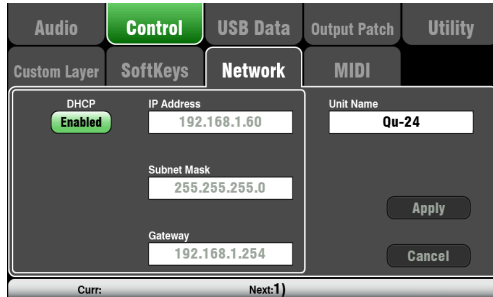

Use this screen set the TCP/IP address for the Network port and the name used to identify the Qu mixer on the network.

It is important that the network address is compatible with the addresses of equipment connected to the port, for example a laptop providing MIDI control of mixer parameters, or a wireless router providing remote control using the Qu-Pad iPad app.

DHCP – Enable this if the connected device has DHCP capability and is therefore able to automatically allocate a compatible IP address to the mixer. This is the factory default and is the typical setting for connecting to a wireless router used to interface with an iPad.

For manual setting of the network address, enter compatible **IP Address**, **Subnet Mask** and **Gateway** settings.

Unit Name – Enter a name with up to 15 characters to identify the Qu mixer on the network. The default name is the model number, for example, 'Qu-16' or 'Qu-24'.

8.7 Control Setup - MIDI

The Qu mixer can send and receive MIDI messages for remote control of many of its functions. It also provides MMC transport control from this page, or assigned to SoftKeys. The Qu uses two MIDI channels, one for Qu mixing functions, the other for DAW control using the Custom Layer.



MIDI over USB – The rear panel USB B port allows direct connection to Apple® Mac computers running OSX 10.6 or later. This carries MIDI and audio streaming. USB B is the recommended connection for DAW and other computer based MIDI control.

Note – USB MIDI is supported natively by the Mac so no driver is needed. A driver for Windows® computers can be downloaded from the Allen & Heath web site.

MIDI over TCP Network – The rear panel Network port is used for connection to a WiFi router to work with an iPad running the **Qu-Pad** app. The app uses these MIDI messages to remotely control the Qu mixer. Alternatively, the Network port can be used with a touch panel or other remote controller that allows configurable MIDI over a TCP/IP port.

Note – Qu currently allows only one TCP connection at a time over its Network port.

MIDI channel number – The Qu uses two MIDI channels, one for mixing functions, the other for DAW control. Choose and **Apply** the mixing function MIDI channel. DAW control will use the next MIDI channel above that.

MIDI control available:

- Mutes
- Faders and Pan
- Audio Group Assign (not Qu-16)
- Mix and FX Sends, Pan, Assign, Pre
- LR Assign
- Matrix sends, Pan, Assign, Pre (not Qu-16)
- Mute/DCA Group Assign, master Mute
- PAFL select
- Input channel source
- Preamp Gain/Trim, Pad, 48V
- Insert In/Out
- Input Polarity, Gate, PEQ, Comp, Delay
- Mix PEQ, GEQ, Comp, Delay
- Scene Recall
- FX Tap Tempo
- MIDI Custom strips (DAW control)
- MMC (MIDI transport control)
- Bank Up/Down (DAW control)

8.8 USB Data – Scene Transfer

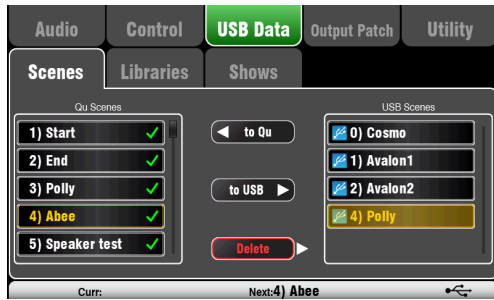

Individual Scenes can be transferred between Qu mixers via a USB device (key or drive) plugged into the Qu-Drive port. This provides a quick way to transfer settings without overwriting the current scenes and preferences.

Make sure the USB device has been previously formatted using the Qu mixer **Utility / Qu-Drive** screen.

The list on the left displays a list of scenes stored in the Qu mixer. The list on the right displays those found on the USB device. Scenes are transferred as data files numbered from '0'. Both the number and name will appear in the USB list.

To Qu – Touch to highlight a USB Scene to transfer. Touch a Qu Scene to highlight the position to transfer to. Once both are highlighted touch 'to Qu'. A confirmation box appears if you are about to overwrite an existing scene. Once transferred, the highlighted scenes increment ready to transfer the next if required.

To USB – Highlight both positions as above. Touch 'to USB' to transfer.

Delete – Highlight a scene in either list. Touch 'Delete' to remove it. Scenes can be deleted from either the Qu or from the USB device.

8.9 USB Data – Library transfer



Individual processing and FX Libraries can be transferred between Qu mixers via a USB device (key or drive) plugged into the Qu-Drive port.

Make sure the USB device has been previously formatted using the Qu mixer **Utility / Qu-Drive** screen.

The list on the left displays a list of libraries stored in the Qu mixer. The list on the right displays those found on the USB device. Libraries are transferred as data files numbered from '0'. Both the number and name will appear in the USB list.

To Qu – Touch to highlight a USB Library item to copy to the Qu mixer. Touch 'to Qu' to copy the item. Once copied, the highlighted library increments ready to copy the next if required.

To USB – Touch to highlight a Qu Library item to transfer via USB. Touch 'to USB' to copy the item to USB. Once copied, the highlighted library increments ready to transfer the next if required.

Delete – Highlight a library in either list. Touch 'Delete' to remove it. Libraries can be deleted from either the Qu or from the USB device.

8.10 USB Data – Show transfer

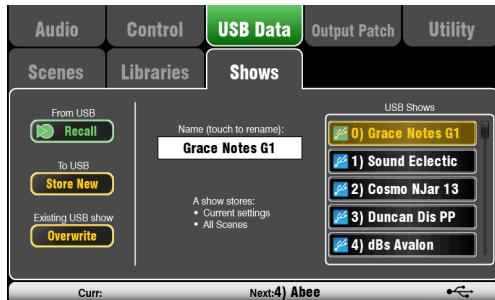

A Show stores the following:

- Current mixer settings
- Mixer setup and preferences
- All Scenes
- All User Libraries
- MIDI channel number

A Show does not store:

- Network settings
- User profile settings

Qu mixer settings can be stored to a USB device (key or drive) plugged into the Qu-Drive port. Data can be archived to computer and transferred between Qu mixers.

A 'Show' stores all the Qu mixer settings and memories. It is stored as a set of files in a numbered folder on the USB device. Shows are not stored in the Qu mixer.

The Qu mixer displays a list of Shows found on the USB device. Shows are numbered from '0'. They can be named. Both the number and name will appear in the USB list.

Make sure the USB device has been previously formatted using the Qu mixer **Utility / Qu-Drive** screen (described later in this guide).

Store New – Touch to store a new Show folder on the USB device. This opens the screen keypad for naming the Show.

Recall – Select a Show in the USB list. Touch the button to overwrite the current Qu mixer settings with the contents of the USB Show. A popup will appear.

Note - If you want to keep your existing Qu settings then store these first as a new Show before recalling another Show.

Overwrite – Existing USB Shows can be overwritten with the current mixer settings. Touch to overwrite the highlighted Show in the USB list with the current Qu mixer settings.

Name – Touch the Name box to open the screen keypad and rename the Show highlighted in the USB list.

The Show folder

Each Show is stored as a set of data files within a numbered folder in the AHQU / SHOWS directory. The first show is numbered '0'.

Note - Do not rename or edit the Show folder or its files.

If you want to archive the Show on your computer we recommend you copy the numbered Show folder to a new named directory on your computer. To use the Show again copy just the numbered Show folder back into the SHOW directory of the USB device.

Note - Do not change the format of the Show folder. Its name must have 8 characters = SHOWnnnn where nnn is a number from 0000 upwards.

Note - The Show name is stored within a data file in the numbered Show folder on the USB device. The name is not part of the folder name. It is held within the SHOW.DAT file in the folder.

To view the Show name on your computer – Open the numbered Show folder and find its SHOW.DAT text file at the end of the list. Open the file to view the Show name. Do not edit the file.

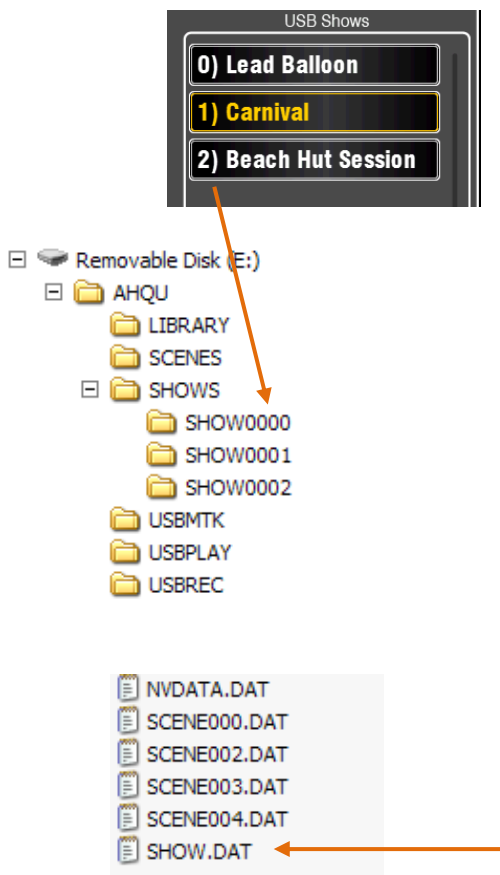

8.11 Output Patch Setup – Surface



Use this screen to patch signals to the rear panel Alt Out and AES outputs. Touch a box to open up the list of available options. Changes are applied instantly. You can also touch outside the list to exit.

Alt Out – Choose the source for the rear panel stereo Alt Out jacks.

AES Out – Choose the source for the rear panel AES digital output.

The reset default for both is LR post-fade.

Group and Matrix outputs are not available on the Qu-16.



8.12 Output Patch Setup – dSNAKE

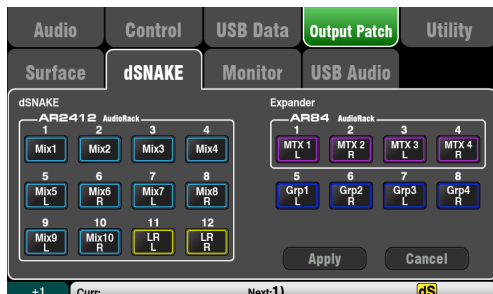

This screen presents the patching for the dSNAKE remote audio outputs. These outputs can be mapped from any combination of Qu mixer output sources.

The Qu mixer detects which AudioRack type is connected. A Qu system can have up to two AudioRacks connected. These are shown as:

dSNAKE – The first (main) AudioRack connected.

Expander – The second (expander) AudioRack.

dSNAKE outputs can be patched with or without physical AudioRacks connected.

The following sources can be patched:

X	Unassigned
Grp	Group post-fader
Mix	Mix 1-10 post-fader
LR pre	LR mix – pre-fader
LR post	LR mix – post-fader
L+R pre	LR mono sum – pre-fader
L+R	LR mono sum – post-fader
MTX	Matrix post-fader
PAFL	Stereo PAFL monitor

All Qu mixer patching is stored in Scene memories. The Reset Mix Settings defaults are shown below:

Qu-16 Reset dSNAKE Patch

dSNAKE	Qu out	Ch	Qu out	Exp	Qu out
1	Mix 1	9	Mix 9	1	none
2	Mix 2	10	Mix 10	2	none
3	Mix 3	11	L	3	none
4	Mix 4	12	R	4	none
5	Mix 5			5	none
6	Mix 6			6	none
7	Mix 7			7	none
8	Mix 8			8	none

Qu-24 and Qu-32 Reset dSNAKE Patch

dSNAKE	Qu out	Ch	Qu out	Exp	Qu out
1	Mix 1	9	Mix 9	1	MTX1 L
2	Mix 2	10	Mix 10	2	MTX2 R
3	Mix 3	11	L	3	MTX3 L
4	Mix 4	12	R	4	MTX4 R
5	Mix 5			5	Grp1 L
6	Mix 6			6	Grp2 R
7	Mix 7			7	Grp3 L
8	Mix 8			8	Grp4 R

8.13 Output Patch Setup - Monitor



This screen presents the patching of the dSNAKE remote monitor audio outputs. This allows the Qu mixer to work with the Allen & Heath **ME Personal Monitor** mixing system.

A ME-1 mixer or ME-U distribution hub can be plugged into any of these sockets:

- Qu rear panel dSNAKE port
- AR2412 MONITOR port
- AR2412 EXPANDER port
- AB168 EXPANDER port

There are 40 Monitor output channels. These can be patched from any input channels, FX, Groups Mixes and PAFL.

Mono (CH) and stereo (ST) channel sends follow the Global Direct Output settings. Mixes are post-processing, post-mute, post-fader.

Note - Set the Global Direct Out source using a channel **Routing** screen. Set pre-fade, post-mute when working with the ME Personal Monitor System.

Qu-16 Reset Default Monitor Patch

Ch	Qu out	Ch	Qu out	Ch	Qu out	Ch	Qu out	Ch	Qu out
1	CH1	9	CH9	17	ST1 L	25	FX1ret L	33	Mix3
2	CH2	10	CH10	18	ST1 R	26	FX1ret R	34	Mix4
3	CH3	11	CH11	19	ST2 L	27	FX2ret L	35	Mix5 L
4	CH4	12	CH12	20	ST2 R	28	FX2ret R	36	Mix6 R
5	CH5	13	CH13	21	ST3 L	29	FX3ret L	37	Mix7 L
6	CH6	14	CH14	22	ST3 R	30	FX3ret R	38	Mix8 R
7	CH7	15	CH15	23	Main L	31	Mix1	39	Mix9 L
8	CH8	16	CH16	24	Main R	32	Mix2	40	Mix10 R

Qu-24 Reset Default Monitor Patch

Ch	Qu out	Ch	Qu out	Ch	Qu out	Ch	Qu out	Ch	Qu out
1	CH1	9	CH9	17	CH17	25	ST1 L	33	Grp1 L
2	CH2	10	CH10	18	CH18	26	ST1 R	34	Grp2 R
3	CH3	11	CH11	19	CH19	27	ST2 L	35	Grp3 L
4	CH4	12	CH12	20	CH20	28	ST2 R	36	Grp4 R
5	CH5	13	CH13	21	CH21	29	ST3 L	37	Mix7 L
6	CH6	14	CH14	22	CH22	30	ST3 R	38	Mix8 R
7	CH7	15	CH15	23	CH23	31	FX1ret L	39	Mix9 L
8	CH8	16	CH16	24	CH24	32	FX1ret R	40	Mix10 R

Qu-32 Reset Default Monitor Patch

Ch	Qu out	Ch	Qu out	Ch	Qu out	Ch	Qu out	Ch	Qu out
1	CH1	9	CH9	17	CH17	25	CH25	33	Grp1 L
2	CH2	10	CH10	18	CH18	26	CH26	34	Grp2 R
3	CH3	11	CH11	19	CH19	27	CH27	35	Grp3 L
4	CH4	12	CH12	20	CH20	28	CH28	36	Grp4 R
5	CH5	13	CH13	21	CH21	29	CH29	37	Mix7 L
6	CH6	14	CH14	22	CH22	30	CH30	38	Mix8 R
7	CH7	15	CH15	23	CH23	31	CH31	39	Mix9 L
8	CH8	16	CH16	24	CH24	32	CH32	40	Mix10 R

8.14 Output Patch Setup – USB Audio



This screen presents the patching of the USB audio outputs. This includes the Qu-Drive Stereo, Qu-Drive Multitrack and the USB B audio streaming.

Note - The Qu-16 provides 24 patchable USB outputs. The Qu-24 and Qu-32 provide 32 USB outputs.

Qu-Drive and USB B streaming share the same block of patchable tracks:

- Qu-Drive Stereo = Track 17-18
- Qu-Drive Multitrack = Track 1-18
- USB B Streaming = Track 1-32 (Qu-16 has 24)

There are two screens:

- Track 1-18 = Tracks associated with Qu-Drive
- Track 19-32 = The rest of the tracks for USB B



Touch the lower left '19-32' or '1-18' buttons to navigate between the screens

Touch a button and then turn the screen Rotary to scroll through the available output sources.

Use the **Fn** key '+1' function to quickly assign strips in sequence.

Once you have chosen the outputs press **Apply** to accept or **Cancel** to discard the changes.

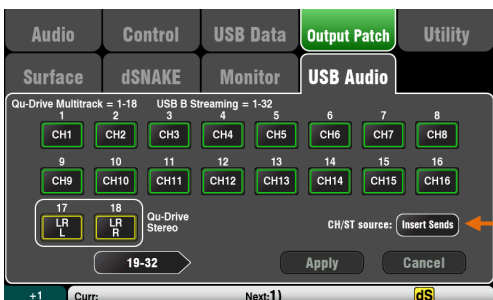

CH/ST/Grp source button

Set this to **Insert Sends** if you do not want the input channel and group USB sends to be affected by the mixer processing (EQ, Comp, Gate, Delay). This sends the raw Preamp and unprocessed Group signals to the USB stream and is the typical setting for live recording.

Set this to **Direct Outs** if you want the input channel USB sends to follow the channel global Direct Output option. It also sets the Group sends to be post-processing and post-fader. This is the typical setting for studio recording (working with a DAW).

Note – The global Direct Output option affects all inputs and is set in the channel **Routing** screen.

Output sources are post processing, post fader.

The USB Audio factory reset default patching varies according to Qu model. All ensure that tracks 17-18 = LR post-fader for Qu-Drive stereo recording. The patching can be changed here to suit your requirements.

Note – Set the USB Audio Patching before using Qu-Drive or USB streaming.

The following sources can be patched:

X	Unassigned
CH	Mono channel (Insert or Direct Out)
ST	Stereo channel (Insert or Direct Out)
FX Ret	FX returns 1-4 pre-fader
Grp	Group (Insert or post-fader)
Mix	Mix 1-10 post-fader
LR pre	Main LR mix – pre-fader
LR post	Main LR mix – post-fader
L+R pre	Main LR mono sum – pre-fader
MTX	Matrix post-fader
PAFL	Stereo PAFL monitor

8.15 Utility - Calibration

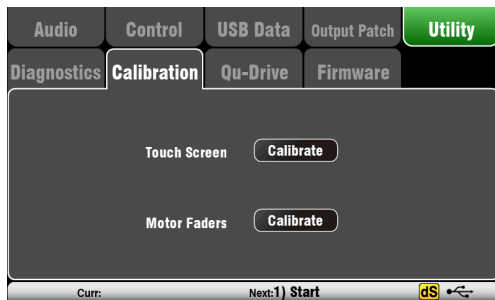

Use the routines here to calibrate the touch accuracy of the **Touch Screen** and positional accuracy of the **Motor Faders**.

Follow the on-screen instructions.

8.16 Utility – Qu-Drive



This screen lets you check and format a USB device (key or hard drive) for use with Qu-Drive. Once formatted you do not need to format it again.

Note – Formatting the USB device will erase all current data on it. If you want to keep this then make sure you archive the data elsewhere first.

For reliable performance you must first format your USB device using the Qu mixer Format utility. Once formatted, use this with Qu only. Do not use the device for other applications.



Note – Qu-Drive audio recording and multitrack playback require the USB storage device to support high sustained transfer rates. Not all USB devices will guarantee flawless performance.

To find out more please refer to the 'Understanding Qu-Drive and USB' document in the Qu Knowledgebase on the Allen & Heath web site.

Once formatted on the Qu mixer, use the USB device with the mixer only. Do not use it for other storage and applications.

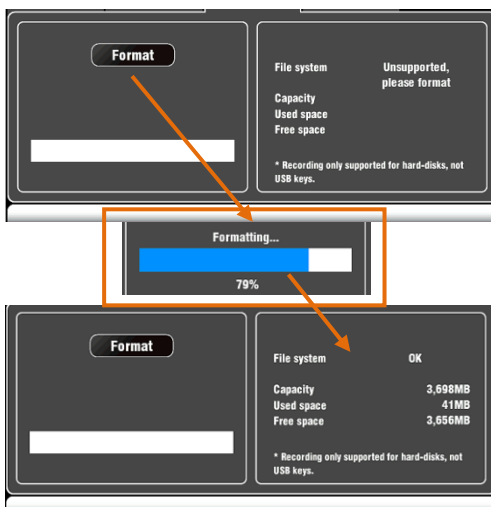

Plug in the USB device. Wait for the mixer to read the drive. The status window displays information about the USB device:

File system: **OK** (no need to format)
File system: **Unsupported** (you need to format it)

Touch **Format** to start formatting. When complete, wait a few seconds for the mixer to read the key. If successful the status window will display 'OK'.

Note – Do not remove the USB device or turn off power until formatting is complete.

8.17 Utility – Firmware Update

The Qu mixer operating firmware can be easily updated using a USB device (key or drive).



Make sure the USB device has been previously checked and formatted to work with the Qu mixer.

If you need to format the device then use the Format facility in the **Setup / Utility / Qu-Drive** screen.

Step1 Download the firmware

Visit the Allen & Heath web site and download the latest Qu firmware. Choose the firmware for your Qu mixer model. The file has a .QUU extension and a name that includes the model and version number. Save the file to your computer. For example: [Qu16UpdtV1_23_4567.QUU](#)

Read the Release Notes available on the download page.

Step2 Remove previous Qu Firmware from USB

It is important to remove previous firmware files as the Qu will attempt to load the first version it finds. The firmware file is in the root directory of the USB device and has a .QUU extension.

Step3 Copy the file to the USB root directory

The Qu mixer will look for a valid firmware file in the root directory of the device.

Step4 Run the Firmware Update

Plug the USB device into the Qu-Drive port.

Open the **Setup / Utility / Firmware** screen. If valid firmware is found its version number will be displayed on the screen. For example:

Touch the **Update** button. The update will start immediately. The screen goes blank and the Pan control indicators flash in sequence while the update is running. After a few minutes the mixer will reboot.



Important note Do not remove power during the firmware update. Do not remove the USB device until the update has completed.

The mixer restarts automatically after the firmware update.

9. Working with Audio Streaming and a DAW

The Qu mixer can stream audio and send MIDI messages to and from an Apple® Mac or Windows® PC computer via the rear panel USB B port. This lets you work with a DAW (Digital Audio Workstation) running on your computer. The Custom Layer can provide MIDI control faders and keys. You can work with the standard Qu MIDI messages or download the Allen & Heath DAW Control driver (available for the Mac computer only) to convert these into one of the popular HUI or Mackie Control protocols.

Note – Make sure you are running a version of V1.3 or higher. Check for the latest firmware at the Allen & Heath web site.

Apple® Mac

USB audio streaming with Qu MIDI message control is supported natively by the Mac so it does not require any driver. If you wish to convert the standard Qu MIDI messages into the HUI or Mackie Control protocol, download and install the **Allen & Heath DAW Control** driver.

Windows® PC

USB audio streaming with Qu MIDI message control needs a driver. Download and install the **Allen & Heath Qu Windows Driver**. Power up the Qu mixer, connect its rear panel USB B port to the PC, run the installer and follow the instructions on the screen. The driver is ASIO 2.2 compliant and supports standard WDM/DirectX Windows interfaces including MME and DirectSound.

Note – DAW Control is available only for Apple® Mac computers. It is not available for the Windows® PC.

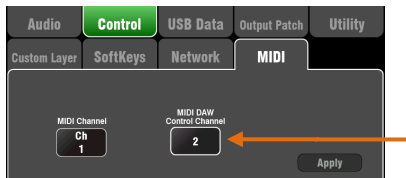

Set the Qu mixer MIDI channel number – Use the **Setup / Control / MIDI** screen to set the Qu MIDI channels. Qu DAW control uses its own MIDI channel. This is the next number up from that set for the other Qu MIDI messages. Qu defaults to Channel 1 for standard messages and Channel 2 for DAW control.

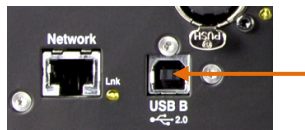

Connect the Qu mixer to the computer – Plug a suitable cable into the rear panel USB B port.



Set the Custom Layer for fader control – Use the **Setup / Control / Custom Layer** to assign the faders as MIDI strips. MIDI Strip controls transmit and receive CC and Note on/off messages. Refer to the Qu MIDI Protocol Document on the Allen & Heath web site for further information.

DAW control (MIDI channel **N+1**):

- Mute key / indicator = **Mute**
- Sel key / indicator = **Select**
- PAFL key / indicator = **Solo**
- Fader movement = **Fader**

Using DAW Control (Mac computer only)- Install this on your Mac and follow the setup instructions in its Help Manual.

DAW Control converts the Qu MIDI Strip messages into HUI or Mackie Control protocol. Set the MIDI channel to be the same as the Qu mixer DAW channel. For USB connection select **MIDI Ports**. Select the MIDI Input and Output ports to be used.



Two squares in the status bar flash to display MIDI I/O activity. To check you are connected to the mixer, the left square should flash when you move any Qu fader.



DAW Bank Up/Down – You can assign SoftKeys as Bank Up and Bank Down to scroll through the banks on the DAW when using DAW Control (Mac computers only)

MMC transport Control – Transport controls are available in the **Setup / Control / MIDI** screen. These can also be assigned to SoftKeys for quick access. Assign the SoftKeys using the **Setup / Control / SoftKeys** screen.

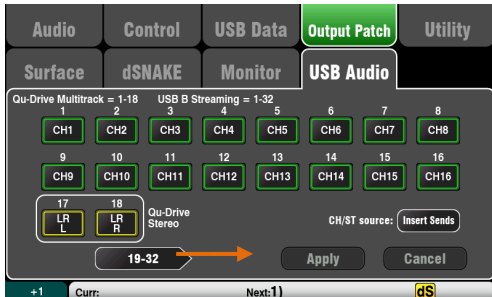

Stream audio to the computer – Audio is sent via the rear panel USB B port. Go to the **Setup / Output Patch / USB Audio** screen to choose which Qu outputs to patch to the USB stream.

The following sources can be patched:

X	Unassigned
CH	Mono channel (Insert or Direct Out)
ST	Stereo channel (Insert or Direct Out)
FX Ret	FX returns 1-4 pre-fader
Grp	Group (Insert or post-fader)
Mix	Mix 1-10 post-fader
LR pre	Main LR mix – pre-fader
LR post	Main LR mix – post-fader
L+R pre	Main LR mono sum – pre-fader
MTX	Matrix post-fader
PAFL	Stereo PAFL monitor



CH/ST/Grp source button

Set this to **Insert Sends** if you do not want the input channel and group USB sends to be affected by the mixer processing (EQ, Comp, Gate, Delay). This sends the raw Preamp and unprocessed Group signals to the USB stream and is the typical setting for live recording.

Set this to **Direct Outs** if you want the input channel USB sends to follow the channel global Direct Output option. It also sets the Group sends to be post-processing and post-fader. This is the typical setting for studio recording (working with a DAW).

Note – The global Direct Output option affects all inputs and is set in the channel **Routing** screen.

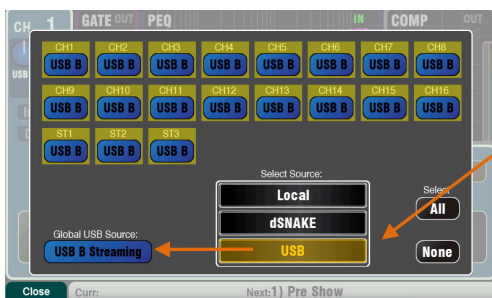

Stream audio back to the Qu mixer – Audio is returned via USB B. This is mapped one-to-one to the inputs channels. Use the **Preamp** screen **Fn** key Source page to patch USB B to the channels.

Make sure you have set 'USB B Streaming' as the global USB source.

Mac - Change this in the OS X preferences. Go to Utilities / Audio MIDI Setup / Audio Devices, select the Qu mixer and click on Configure Speakers. Then assign stereo Left and Right to the required interface output.

PC – From Qu Windows Driver version 2.20.5 onwards this audio returns to the Qu-16 and Qu-24 ST3 channel, or to CH31-32 for the Qu-32. Download the latest driver from the Allen & Heath web site.

Note - Most DAWs allow flexible patching and routing of tracks to/from any interface I/O. However if you are using iTunes, QuickTime or similar for playback to the mixer, the stereo output will default to the Qu Input CH 1 and 2. You can change this manually on the Mac, and use the latest version of the Qu Windows Driver on the PC.

10. iOS Apps for Wireless Control

Two Qu apps are available from the Apple Store:

Qu-Pad - Engineer's live mixing control

Qu-You - Musician's personal monitor control



Qu-Pad is an engineer's mixing tool giving you the freedom to walk the room or stage and control the sound right where it is needed. Qu-Pad gives you control of the live mix. It is not for system setup or memory management which can be accessed at the mixer. Qu-Pad and the Qu console can work together to provide simultaneous control of independent functions, for example one engineer using the console to mix front-of-house sound, and another using the iPad to mix monitors on stage.

Qu-Pad runs on all models of iPad running iOS5.1.1 or higher. Current version tested at the time of this release is iOS8.

Note – Current firmware supports only one iPad running **Qu-Pad**. However, you can connect up to 7 additional iPhones, iPads or iPod Touch devices running the **Qu-You** monitor app.

LR mix selected, CH preamp shown



CH PEQ shown



Custom Layer setup



Live mixing functions available:

- Fader levels, mutes, pan
- Aux and FX sends, routing and Pre/Post switching
- Group masters and routing (not Qu-16)
- Matrix masters (not Qu-16)
- Input Preamp/USB selection
- Preamp Gain, Pad, Polarity and 48V
- HPF, Gate, PEQ, GEQ, Comp, Delays
- FX Tap Tempo
- Mute Groups
- DCA Groups
- RTA function
- PAFL select
- Full signal metering
- Custom strips for personalised channel layout
- Channel naming (stored in the Qu mixer)

Setup functions not available:

- FX patching and parameter setup
- Local/dSNAKE Preamp source selection
- Global Qu-Drive/USB B source selection
- Insert switching and channel linking
- Output patching
- Aux source routing options
- Matrix sends and routing
- Scenes and Libraries
- Show memory store and load
- Scene Recall Filters and Safes edit
- Copy/Paste/Reset of parameters
- SoftKeys
- Signal Generator
- Talkback
- System configuration, options and preferences

Touch to select a Mix



Channels can be assigned to up to 4 local groups, each with its own thumbwheel level control.

Double tap a wheel to access its channel levels, pan and meters.

Qu-You provides personal monitor mix control for musicians and performers on stage. The engineer can still keep an eye on and control each mix at the Qu mixer at any time.

Qu-You runs on Apple iOS devices including iPhone4 or later, iPad, iPad Mini or iPod Touch running iOS7 or later.

Note – You can connect up to 8 iOS devices to the Qu mixer. This includes multiple devices running **Qu-You**, and the one iPad running **Qu-Pad** if that is also being used.

Qu-You lets you:

- Choose which Mix to control
- Select Mix 1,2,3,4,5-6,7-8 or 9-10
- View channels numbers and names
- Assign which sources to access
- Sources can be CH, ST, FXret, Grp
- Assign up to 4 group level wheels
- Use the 'Me' group for your own channels
- Name each Group
- Control master fader and mute
- Control input send levels and pan
- Rotate for portrait or landscape view

Touch to name the group.



Using the Qu-Pad or Qu-You app

Qu Mixer Requirements - The Qu mixer firmware and Qu-Pad feature release version number must be the same, for example V1.5 firmware will not run with the V1.6 app. However, the maintenance version numbers do not need to be identical, for example Qu-Pad V1.60 would run with Qu mixer V1.61. Refer to the Allen & Heath web site for more information and to download the latest Qu mixer firmware.

Set up the wireless network – Connect and configure a suitable wireless router as described below. Connect the iOS device to this network.

Start the app and log in to the Qu mixer – The app opens in its Login page. You should see your Qu mixer in the list if it is recognised on the wireless network. Select this and touch Connect.

The app detects the Qu mixer model – Qu-16, Qu-24 or Qu-32. Some settings such as Qu-Pad Custom layers and Qu-You Group names and assignments are stored locally and remembered when the app is started.

More information – Read the Help Manual by touching the ? button on the Login page for further instructions on how to set up and operate Qu-Pad.

More information is available in the Knowledgebase and Digital Community on the Allen & Heath web site.

Setting up the Qu wireless network

The app sends and receives control data over a wireless (Wi-Fi) network. This requires a wireless router (wireless access point) connected to the Qu mixer Network port.

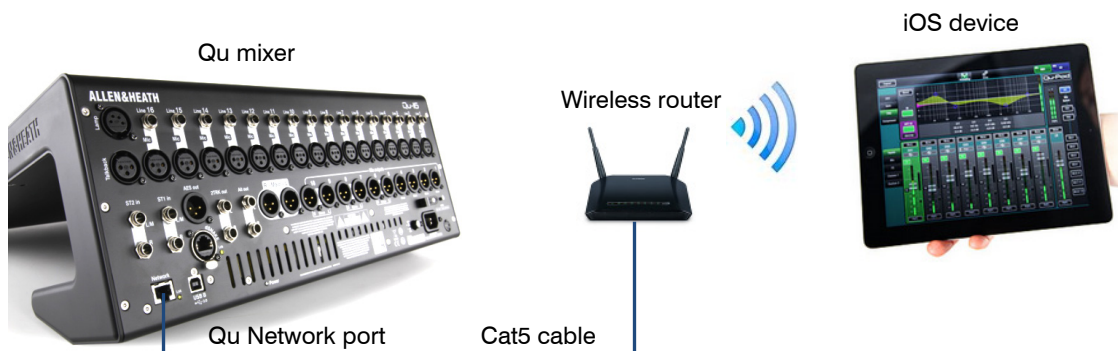

Choosing a wireless router - For best performance we recommend you use a dual band (2.4 and 5GHz) wireless router (wireless access point) with auto channel selection. A wireless router with auto channel selection automatically sets itself to an available or least congested channel when you power it up.

Setting up the Qu mixer Network - The default setting is DHCP enabled. This is recommended as it means that the mixer gets its network IP address automatically from a DHCP enabled router. Go to the mixer **Setup / Network** screen to check that DHCP is enabled.

If you choose to use manual network settings then you need to make sure that both the mixer and the router have compatible TCP/IP addresses.

Setting up the wireless router – The default settings of many routers are immediately compatible with the Qu mixer so you should be able to connect quickly. However, if you do experience difficulty or wish to change security settings then you will need to access the router setup utility. To do this, connect the router to a PC or Mac using a wired LAN (network) connection to access its setup menus. Follow the instructions provided by the wireless router manufacturer.

Wireless router DHCP settings - Make sure the router is set for DHCP so that it automatically allocates a compatible IP address to your iPad. This is the default setting for most routers.

Wireless security -To prevent other people accessing your Wi-Fi we recommend you enable WPA/WPA2 encryption. A wireless key (password) will need to be assigned. Make a note of this as it will be needed to log on to the network. MAC address filtering is another method that can be used for security.

SSID - This is the name broadcast by the wireless router to help identify it in the network list you will see in the device Settings Wi-Fi page.

Positioning your wireless router – It is important that your iOS device operates within the specified range and in line of sight of the wireless router. Place it high up to avoid obstacles such as people and equipment. Avoid locating it behind pillars or walls, near metal beams or on top of loudspeakers.

Connecting to the wireless router - Make sure the iOS device Wi-Fi is turned ON in its Settings screen. Choose your wireless router from those shown in the Network list. Enter the password to connect to the router. After a few moments a tick should appear to show the iPad has successfully connected to the wireless network. Check that the icon in the iPad top toolbar shows good Wi-Fi signal strength.

Note – To prevent unauthorised control of your Qu mixer we strongly recommend that you password protect your wireless network.

Note - The iPad remembers the network settings. To prevent an iPad connecting again in future without the password, for example if you have given a guest engineer access your Qu with their own iPad, select your network in their iPad Settings Wi-Fi menu and use the 'Forget this network' function.

If you experience connection problems or drop outs – You may suffer interference from other wireless networks or equipment in the area. Try rebooting the router to pick up a different channel, or change its band (2.4 or 5GHz).

11. Resetting the Mixer

There are two ways to reset the Qu settings:

11.1 Reset Mix Settings – A starting point for mixing

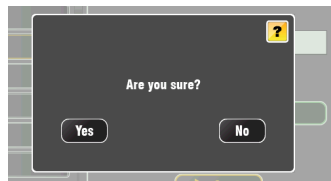

Reset mix settings:

- Source Preamp, Gain 28dB, 48V off
- ST1-3 trim 0dB
- HPF out, 100Hz
- PEQ and GEQ in, flat
- Gates out, thres -36dB, depth 20dB
- Comp out, thres 0dB, ratio 3.2:1
- Delays 0ms
- Mix source post-EQ
- Sends to Mixes -Inf and pre-fade
- Sends to FX -Inf and post-fade
- Direct Out post-fade/mute, trim 0dB
- Mutes off
- Channel faders -Inf
- FX return faders 0dB
- FX send and Mix master faders -4dB
- LR master fader -Inf
- FX = Mix>Return
- Qu-16 FX = EMT250, Delay
- Qu-24, 32 = EMT250, Hall480, Dly, ADT
- Audio Groups unassigned (not Qu-16)
- Group and Matrix faders -Inf (not Qu-16)
- Matrix sends assigned, post (not Qu-16)
- Mute/DCA Groups unassigned
- DCA Group masters = '0dB'
- AES, Alt Out patch LR post-fade
- Qu-Drive stereo patch LR post-fade
- USB patch default with 17-18 = LR
- USB CH/ST/Grp source = Insert Sends
- Talkback unassigned, HPF 120Hz
- Custom Strip unassigned
- SoftKeys = Mute Groups 1-4
- Channel names cleared

This button in the **Scenes** screen resets the mixer to a known starting point for mixing. It provides a quick way to reset the processing, mixes and patching before a show or after another user has finished with it.

All parameters that can be stored in Scene memories are reset to a factory default. Parameters that are not stored in scenes are not affected. This reset does not affect existing scenes stored in the mixer.

If you want to keep your current settings then save these as a Scene before resetting the mixer.

Note - This reset is not affected by the Global filter and Safes settings.

Touch and hold the **Reset Mix Settings** button for 1 second until the confirmation screen appears. Touch **Yes** to reset the mixer or **No** to exit without resetting. This 'resets the board' ready for mixing:

- All preamps are patched and have nominal mic gain set and phantom power switched off, a good start for vocal microphones,
- All EQ is switched in and set flat ready to start adjusting tone,
- Gates and compressors are switched out but have their parameters set ready for being switched in for applications such as drum gating and vocal compression,
- Channels are assigned to the mixes and FX with their faders and send levels turned down ready to start dialling into the mix,
- The mixes are set pre-fade and sourced post-EQ, pre-compressor ready to be used as monitor sends, a common application for the mixes.
- The FX master and return faders are turned up and default reverbs and delay patched ready for you to hear the effects as soon as you raise a channel send.
- The Mix master faders are turned up ready to hear sound when you raise a channel send. The main LR master is turned down to avoid unexpected loud level in the PA.
- The Groups are unassigned and their master faders turned down (not Qu-16).
- The Matrix sends are assigned and their master faders turned down (not Qu-16).

Creating your own start settings – You can start by resetting the mixer and then editing the patching, levels and parameters to suit your starting preferences. Name and store this as a **Scene**, for example Scene 1 "Reset Board".

11.2 System Hard Reset



Hold for 5 seconds while powering up the mixer



System hard reset:

- 'Reset Mix Settings' default as above
- Input PAFL = PFL, mix = AFL
- PAFL additive mode off
- Sel follow PAFL on, LR to PAFL on
- PAFL trim 0dB, delay 0ms
- Talkback mic gain 27dB
- Sig Gen Pink Noise, unassigned
- Clears all scene Safes
- Clears all Scene memories
- Clears all Scene Filters
- Clears all User Libraries
- Resets all User Permissions
- Resets Network address to DHCP
- Resets touch screen calibration

A power up reset is available if you need to fully reset the Qu mixer settings and memories. This could be done to clear the system out before sending the mixer to a client, or if you suspect a system problem.

To reset mix parameters before starting a show or sound check, use a Scene or the Reset Mix Setting function described earlier in this guide.

Note – A hard reset clears all current settings, all Scenes, User Libraries and User Permissions.

First turn off the system including amplifiers and powered speakers.

To hard reset the Qu mixer - Press and hold the touch screen Reset and Setup keys together and then power up the mixer. Keep the keys pressed for at least 5 seconds while the mixer boots. Release the keys.

The hard reset:

- Resets the current settings the same as using the Scenes screen 'Reset Mix Settings' button.
- Resets non-scene parameters and user preferences to a factory default.
- Clears scene recall Safes and Filters.
- Clears all memories including Scenes, User Libraries and User Permissions.
- Resets the Network IP address and the touch screen calibration.

12. Specifications

12.1 Mechanical Details

The following provides information for mixer installation. The Qu mixer can be operated on a flat surface or fitted into a flightcase. The Qu-16 can be mounted in a 19" equipment rack or plinth.

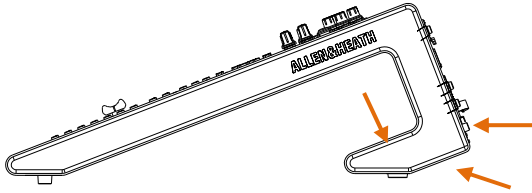

Ventilation - Make sure that air flow around the ventilation slots at the rear and underside of the mixer is not obstructed. Keep these areas clear when flight casing, installing or operating the mixer.

Note - Blocking or obstructing the ventilation slots may cause damage to the mixer through overheating.

Qu-16 = 440 Qu-24 = 632 Qu-32 = 850mm

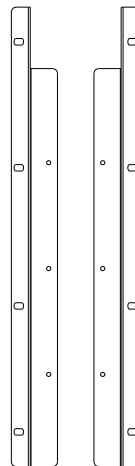
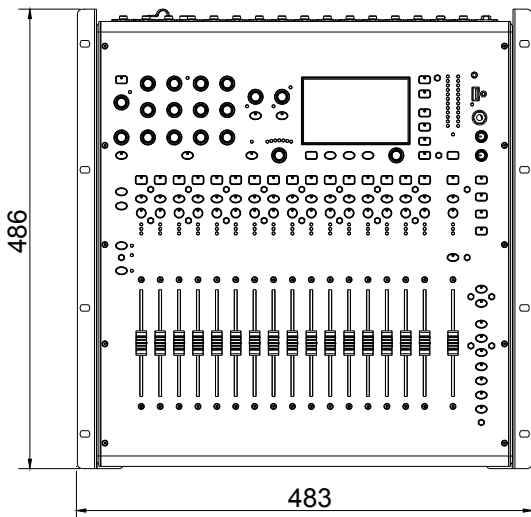
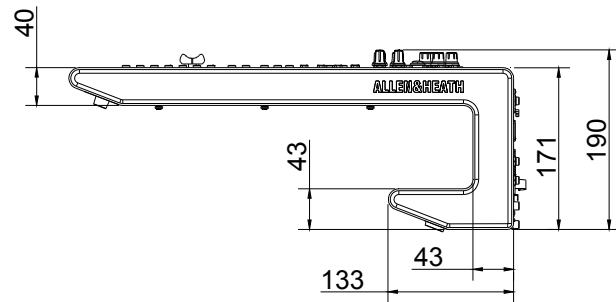
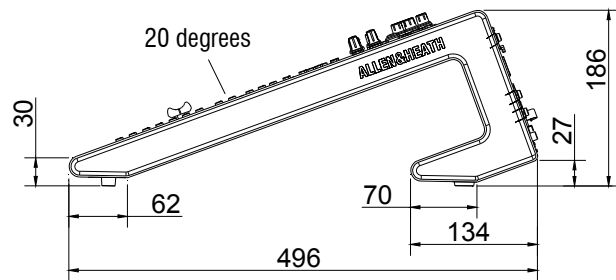
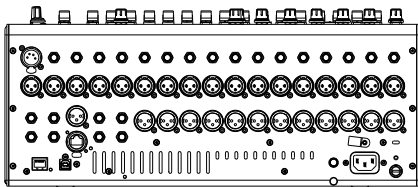
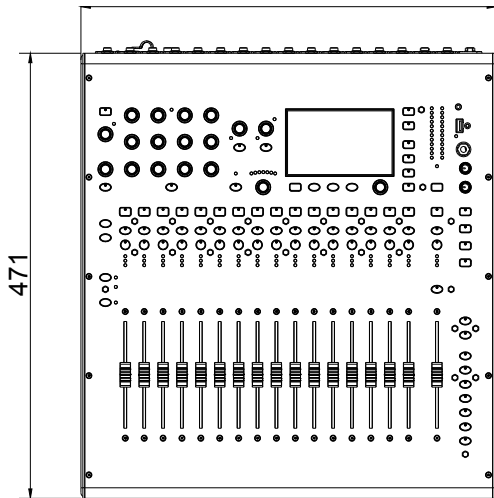

Qu-16 Rack Mount Option

A kit of parts is available from Allen & Heath to mount the Qu-16 in a standard 19" equipment case.

Rack kit part number **QU-16-RK19**

Minimum rack space required is **11U**.

Note - Allow space for the connectors and cables at the rear.

The rack ears can be fitted without the need to remove the plastic side trims. Simply secure them to the base of the mixer with the 6x M4x8 screws supplied (part number AB0332) using a T20 Torx screwdriver.

Secure the mixer in the 19" rack with 8x M6 screws with plastic cup washers to protect the mixer surface.

12.2 Qu-16 System Block Diagram

Qu-16 SYSTEM BLOCK DIAGRAM Firmware V1.5 June 2014

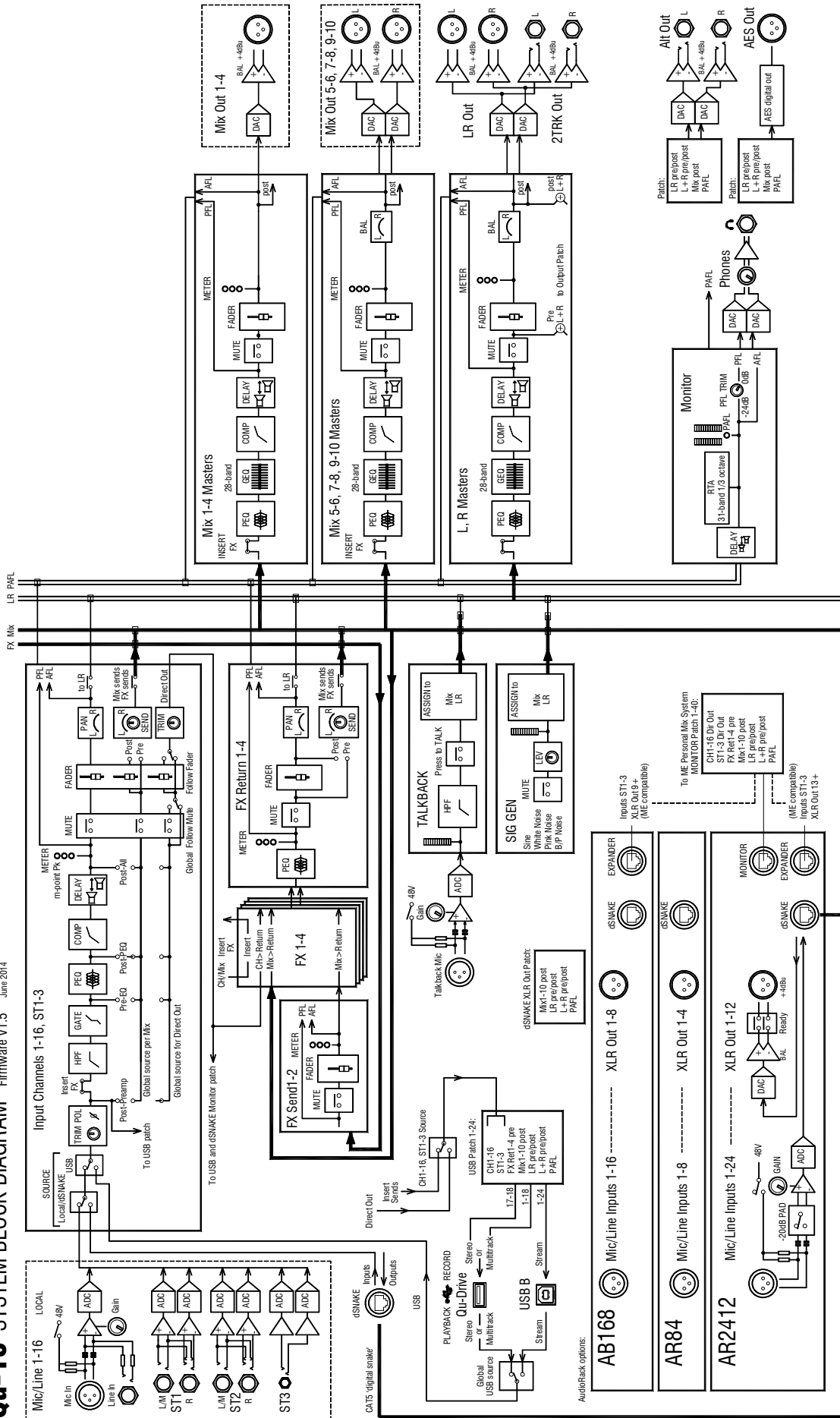

12.3 Qu-24 and Qu-32 System Block Diagram

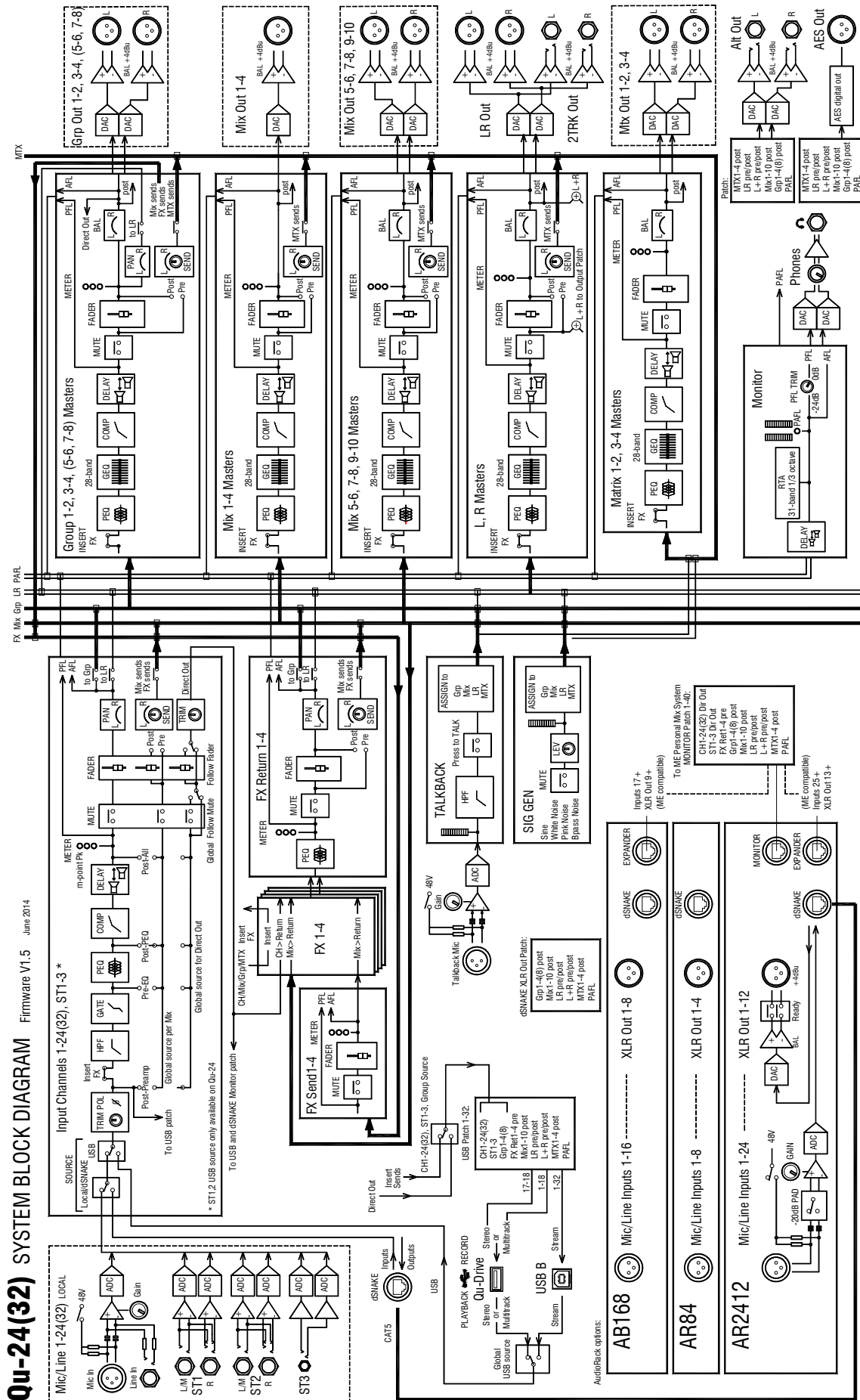

12.4 System Specifications

Inputs	
Mic/Line Inputs	Balanced, XLR and 1/4" TRS jack, fully recallable
Input Sensitivity (XLR / TRS)	-60 to +5dBu / -50 to +15dBu
Analogue Gain	-5 to +60dB, 1dB steps
Maximum Input Level (XLR / TRS)	+19dBu / +29dBu
Input Impedance (XLR / TRS)	>5kΩ / >10 kΩ
THD+N, Unity gain 0dB	0.0005% -89 dBu (20-20kHz, Direct Out @0dBu 1kHz)
THD+N, Mid gain +30dB	0.001% -83dBu (20-20kHz, Direct Out @0dBu 1kHz)
Stereo Line Inputs	
ST1, ST2 connector	Balanced, 1/4" TRS jack, half normalised
ST3 connector	Unbalanced, stereo 3.5mm Mini Jack
Input Sensitivity (ST1, ST2 / ST3)	Nominal +4dBu / 0dBu
Trim	+/-24dB
Maximum Input Level (ST1,ST2 / ST3)	+22dBu / +18dBu
Input Impedance	>7kΩ

Outputs	
Mix1-10 and LR Out	Balanced, XLR
Group and Matrix Out (Qu-24,32 only)	
Output Impedance	<75Ω
Nominal Output	+4dBu = 0dB meter reading
Maximum Output Level	+22dBu
Residual Output Noise	-90 dBu (muted, 20-20kHz)
Stereo AIT Out & 2Trk Out	
Source (AIT Output / 2Trk Output)	Patchable / LR post-fade
Output Impedance	<75Ω
Nominal Output	+4dBu = 0dB meter reading
Maximum Output Level	+22dBu
Residual Output Noise	-90 dBu (muted, 20-20kHz)
AES Digital Output	
	2 channel, 48kHz sampling rate, XLR
	2.5Vpp balanced terminated 110Ω

dSNAKE	
Inputs	Remote source for CH1-32, ST1, ST2, ST3
Outputs	Patchable from Mix1-10, LR, Grp1-8, MTX1-4
	Compatible with AudioRacks AR2412, AR84, AB168
	Compatible with ME personal mixing system

System	
	Measured balanced XLR in to XLR out, 0dB gain, 0dBu input
Dynamic Range	112 dB
Frequency Response	+0/-0.5dB 20Hz to 20kHz
Headroom	+18dB
Internal operating Level	0dBu
dBFS Alignment	+18dBu = 0dBFS (+22dBu at XLR output)
Meter Calibration	0dB meter = -18dBFS (+4dBu at XLR out)
Meter Peak indication	-3dBFS (+19dBu at XLR out), multi-point sensing
Meter Signal indication	-48dBFS (-26dBu at XLR out)
Meter Type	Fast (peak) response
Sampling Rate	48kHz +/-100PPM
ADC, DAC	24-bit Delta-Sigma
Latency	1.2 ms (local XLR in to XLR out)
	0.7 ms (local XLR in to AES out)
Operating Temperature Range	0 deg C to 35 deg C (32 deg F to 95 deg F)
Mains Power	100-240V AC, 50/60Hz
Maximum Power Consumption	Qu-16= 82W, Qu-24= 120W, Qu-32= 150W

USB Audio	
Qu-Drive	USB A
Device	Use a USB hard drive (not a USB key)
Stereo Record	2 channel, WAV, 48kHz, 24-bit, patchable
Stereo Playback	2 channel, WAV, 44.1 or 48kHz, 16 or 24-bit, to ST3
Multitrack Record	18 channel, WAV, 48kHz, 24-bit, patchable
Multitrack Playback	18 channel, WAV, 48kHz, 24-bit
USB Audio Streaming	
	USB B, Core Audio compliant
Send (upstream) Qu-16/24/32	24/32/32 channel, WAV, 48kHz, 24-bit
Return (downstream) Qu-16/24/32	22/30/32 channel, WAV, 48kHz, 24-bit

Dimensions & Weights	
Qu-16 Mixer	Width x Depth x Height
Desk mounted	440 x 500 x 186 mm (17.4" x 19.7" x 7.4")
Rack mounted	483 x 472 x 190 mm (19" x 18.6" x 7.5")
Packed in shipping box	610 x 680 x 350 mm (24" x 27" x 13.8")
Unpacked weight	10 kg (22 lbs)
Packed weight	13.5 kg (30 lbs)
Qu-24 Mixer	Width x Depth x Height
Desk mounted	632 x 500 x 186 mm (24.9" x 19.7" x 7.4")
Packed in shipping box	670 x 790 x 350 mm (26.4" x 31.1" x 13.8")
Unpacked weight	14 kg (31 lbs)
Packed weight	18 kg (40 lbs)

Control	
Faders	100mm motorised
Touch Screen Qu-16, 24	5" TFT, 800x480 resolution
Touch Screen Qu-32	7" TFT, 800x480 resolution
SoftKeys	4 (Qu-16), 10 (Qu-24, 32)
Mute Groups	4
DCA Groups	4
Network	TCP/IP Ethernet for MIDI and iPad app

Input Processing	
Source	
CH1-32	Local, dSNAKE, or USB
ST1, ST2	Local, dSNAKE, or USB
ST3	Local, dSNAKE, or USB Stereo
USB Global Source	Qu-Drive or USB B Streaming
Stereo Linking	
	Odd/even input pairs
Parameters linked	EQ, dynamics, insert, delay, assignments, sends
Link options	Preamp, polarity, sidechains, fader/mute, pan
Polarity	
	Normal/Reverse
High Pass Filter	
	12dB/octave 20Hz – 2kHz
Insert	
	Assign FX1-4 into Input channels
Delay	
	Up to 85ms
Gate	
	Self key Sidechain
Threshold / Depth	-72dBu to +18dBu / 0 to 60dB
Attack / Hold / Release	50us to 300ms / 10ms to 5s / 10ms to 1s
PEQ	
	4-Band fully parametric, 20-20kHz, +/-15dB
Band 1	Selectable LF Shelving (Baxandall), Bell
Band 2, Band 3	Bell
Band 4	Selectable HF Shelving (Baxandall), Bell
Bell Width	Non-constant Q, variable, 1.5 to 1/9th octave
Compressor	
	Self key Sidechain
Threshold / Ratio	-46dBu to 18dBu / 1:1 to infinity
Attack / Release	300us – 300ms / 100ms - 2s
Knee	Soft/Hard
Types	Peak Manual, RMS Manual, SlowOpto, PunchBag
Channel Direct Out to USB	
	Follow Fader, follow Mute (global options)
Source select (global)	Post-Preamp, Pre-EQ, Post-EQ, Post-Delay

Mix Processing	
Insert	Assign FX into Mix channels
Delay	Up to 170ms
GEQ	
	Constant 1/3 oct, 28 bands 31Hz-16kHz, +/-12dB Gain
PEQ	
	4-Band fully parametric, 20-20kHz, +/-15dB
Band 1	Selectable LF Shelving (Baxandall), Bell
Band 2, Band 3	Bell
Band 4	Selectable HF Shelving (Baxandall), Bell
Bell Width	Non-constant Q, variable, 1.5 to 1/9th octave
Compressor	
	Self key Sidechain
Threshold / Ratio	-46dBu to 18dBu / 1:1 to infinity
Attack / Release	300us – 300ms / 100ms - 2s
Knee	Soft/Hard
Types	Peak Manual, RMS Manual, SlowOpto, PunchBag

FX	
Internal FX	4x RackFX engine, Send->Return or Inserted
Types	Reverbs, Delays, Gated Reverb, ADT
	Chorus, Symphonic Chorus, Phaser, Flanger
4 dedicated Stereo FX returns	Fader, Pan, Mute, Routing to Mix/LR, 4-Band PEQ

Audio Tools	
PAFL	PFL or stereo in-place AFL, 0 to -24dB Trim, 85ms Delay
Talkback	Assignable to any mix, 12dB/oct HPF
Signal Generator	Assignable to any mix, Sine / White/Pink/Bandpass Noise
RTA	31-Bands 1/3 octave 20-20kHz, follows PAFL source

Dimensions & Weights	
Qu-32 Mixer	Width x Depth x Height
Desk mounted	850 x 500 x 186 mm (33.5" x 19.7" x 7.4")
Packed in shipping box	1000 x 680 x 350 mm (39.4" x 26.8" x 13.8")
Unpacked weight	20 kg (44 lbs)
Packed weight	24 kg (53 lbs)