



**POD
EXPRESS**



**POD
EXPRESS
BLACK**



**POD
EXPRESS
BASS**

2.00 OWNER'S MANUAL

Contents

Welcome to POD Express	4	Effects Models	23
What's in the Box	4	About the Signal Path and Stereo Functionality	23
Minimum System Requirements	4	Selecting and Adjusting an Effect Model	24
Updating POD Express	4	POD Express Guitar Effects Models	25
POD Express Edit Software	5	POD Express Black Effects Models	26
Top Panel Controls	6	POD Express Bass Effects Models	26
Rear Panel Jacks	8	Using the Looper	27
POD Express Left Panel	9	U.S. Registered Trademarks	28
Quick Start	10	Global Settings	29
Installing Batteries	10	Global Settings Table	30
Installing the Adhesive Rubber Feet	10	Restoring All Global Settings	35
Simple Setup	10	USB Audio	36
Features	13	Hardware Monitoring vs. Software Monitoring	36
Hooking It All Up	13	DI Recording and Re-amping	37
Setting up an Expression Pedal and Footswitches	14	Core Audio Driver Settings (macOS only)	38
Working with Presets	16	ASIO Driver Settings (Windows only)	38
Setting the TAP Tempo	18	POD Express Edit	39
Using the Tuner	18	Software Requirements & Installation	39
Checking Remaining Battery Life	18	Loading and Saving Presets	40
Amp & Cab Models	19	Managing Presets in the Preset Librarian	41
Selecting an Amp Model	19	Editing Amp & Effects Parameters	41
Editing Amp Parameters	20	The Application Menu	43
Speaker Cab Models	21	Configuring the Device's Global Settings	44
		Accessing the Built-in Firmware Updater	44
		Updating POD Express Firmware	45
		Using the Updater in Offline Mode	46

**Supplier's Declaration of Conformity
47 CFR § 2.1077 Compliance Information**

Unique Identifiers: Line 6® POD® Express Guitar, POD® Express Black, and POD® Express Bass

Responsible Party - U.S. Contact Information:

Yamaha Guitar Group, Inc.
26580 Agoura Road
Calabasas, CA 91302-1921
(818) 575-3600
<https://line6.com/>

FCC Compliance Statement:

This device complies with Part 15 of the FCC Rules. Operation is subject to the following two conditions: (1) This device may not cause harmful interference, and (2) this device must accept any interference received, including interference that may cause undesired operation.

© 2024 Yamaha Guitar Group, Inc. All rights reserved.

Yamaha Guitar Group, Line 6, the Line 6 logo, Ampeg, SVT, Portaflex, POD, Helix, and HX are trademarks or registered trademarks of Yamaha Guitar Group, Inc. in the U.S. and/or other jurisdictions. Apple, Mac, macOS, iPad, iPadOS, iPhone, and iTunes are trademarks of Apple, Inc., registered in the U.S. and other countries and regions. Apple is not responsible for the operation of this product or its compliance with safety and regulatory standards. iOS is a trademark or registered trademark of Cisco in the U.S. and other countries and is used under license. Intel is a trademark or registered trademark of Intel Corporation. Windows is a registered trademark of Microsoft Corporation in the United States and/or other countries. Android, Play Store, and YouTube are trademarks of Google LLC. ASIO is a registered trademark of Steinberg Media Technologies GmbH. USB-C is a registered trademark of USB Implementers Forum, Inc.

The Model and Serial numbers can be found on the product label. Please record these numbers below and retain this document for your records.

Model Number: _____

Serial Number: _____

Welcome to POD Express

Manual? I don't need no stinkin' manual!

One of our goals was to design the **Line 6® POD® Express** family devices to be simple enough that you can just plug in and start riffing. But you might miss out on some cool tips, tricks, and shortcuts that help you make better sounding tones and speed up the entire process. You should at least take a look at the *Cheat Sheet* included in the box with your device.

 **TIP:** Be sure to visit [Line6.com/meet-pod-express](https://line6.com/meet-pod-express) for the latest POD Express news, tips, and product information.

What's the Difference?

POD Express devices contain models derived from the award-winning HX® family of processors.

- **POD Express Guitar** contains a versatile collection of essential guitar amps, cabs, and effects to cover a wide range of tones and styles.
- **POD Express Black** includes an authoritative set of guitar amps, cabs, and effects especially selected for metal and heavier styles.
- **POD Express Bass** is designed for bassists, with its own set of classic bass amps, cabs, and effects.

Functionality is much the same for each of the POD Express devices, but you'll want to choose the one that best match your sonic needs—and there is certainly no rule that says you can't get more than one!

What's in the Box

- POD® Express Guitar, POD® Express Black, or POD® Express Bass multi-effects device
- Three AA batteries
- Adhesive rubber feet
- *Cheat Sheet*, Safety & Compliance, and Warranty documentation

Minimum System Requirements

The minimum operating systems supported for POD Express Edit and Line 6 Central applications and USB audio functionality are as follows:

- macOS 11, Big Sur - Apple computers with Intel® and Apple silicon processors are supported
- Windows® 10
- Apple iOS 15 and iPadOS 15
- Android™ 6 for POD Express Edit, Android 8 for USB audio
- Internet connection required for firmware updates via POD Express Edit or Line 6 Central (on macOS or Windows computers)

 **NOTE:** General performance for USB audio can vary, depending on your system's hardware specs and the complexity of your particular audio projects.

Updating POD Express

It is highly recommended to check for and install the latest available firmware update, which can be accomplished easily using the free **POD Express Edit** macOS or Windows application, available at line6.com/software. Please see "[Updating POD Express Firmware](#)" on page 45.

POD Express Edit Software



POD Express Edit (macOS)



POD Express Edit is not only an indispensable librarian for managing and backing up all your presets but also provides simple and expanded editing of all amps, cabs, and effects via your macOS or Windows computer or iOS, iPadOS, or Android mobile device. Please see ["POD Express Edit" on page 39](#) for details.

POD Express Edit is available free at line6.com/software (macOS and Windows computers), the [Apple App Store](#) (iOS and iPadOS devices), and the [Google Play™ Store](#) (Android devices).



***NOTE:** Firmware version 2.00 (or later) is required to use POD Express devices with POD Express Edit. Please use the free **Line 6 Central** application to update your POD Express device's firmware before installing the POD Express Edit application—see ["Updating POD Express Firmware" on page 45](#).

For iOS and Android devices with USB-C ports, a USB-B to USB-C adapter is required. For all other supported iOS or iPadOS devices, a USB-A to lightning adapter is required. For all other Android devices, a USB OTG (On-The-Go) adapter is required. All adapters sold separately.



The POD Express app window (iOS)

Top Panel Controls

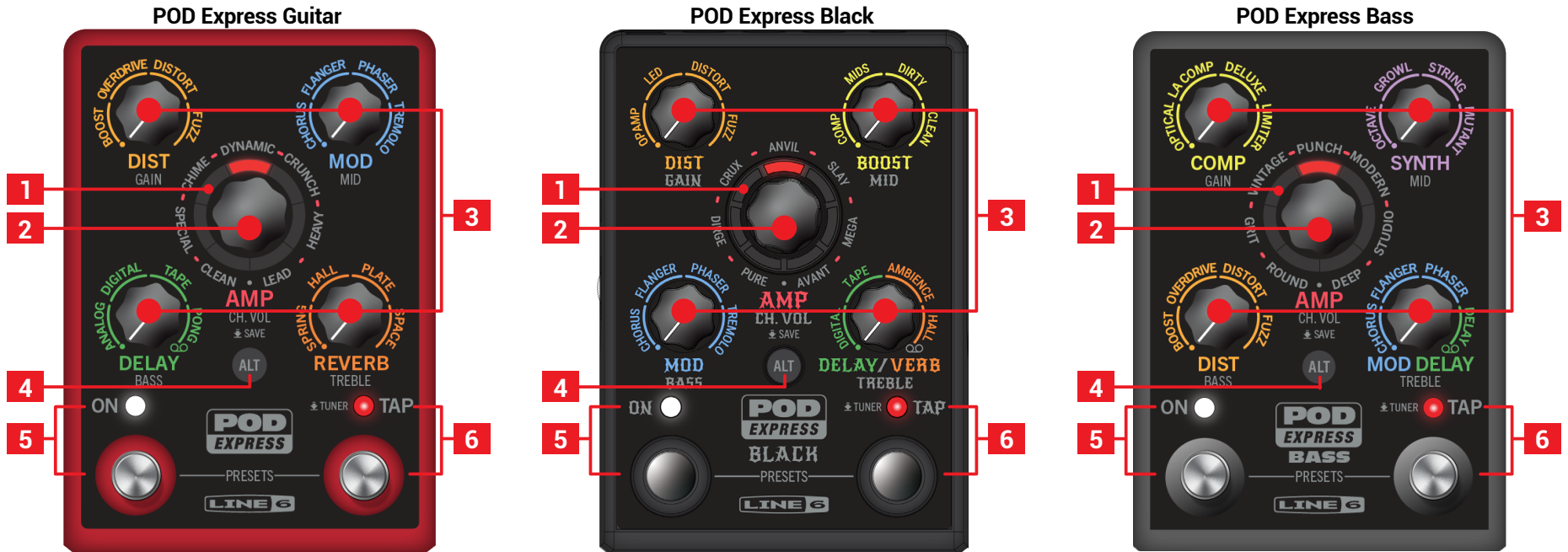

- 1. LED Ring** The seven, multi-color LED segments light to indicate various parameter functions, as covered throughout this Manual. While turning the AMP encoder, a red LED indicates the selected amp model. While holding the ALT button and turning the AMP encoder or Effects knobs, LED segments indicate the corresponding value—see [“Editing Amp Parameters” on page 20](#).

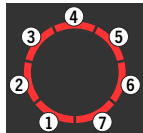

While turning an Effects knob, the AMP encoder’s LED segments light in clockwise fashion 1-7 to indicate the intensity of the current effect model—see [“Selecting and Adjusting an Effect Model” on page 24](#).

When in Global Settings mode, each LED indicates the setting and its selectable values—see [“Global Settings” on page 29](#).

- 2. AMP Encoder** Turn to select an amp model, or turn to the detent at the 6 o’clock position marked by ● for no amp. You’ll see LED segments 1-7 light to indicate the current model (or no LED lit when set to ● for no amp). A matching speaker cab model is also loaded—see [“Selecting an Amp Model” on page 19](#).

Hold the ALT button and turn the AMP encoder or Effects knobs to adjust amp parameters, as indicated by the silver labels beneath each. Hold the ALT button and TAP switch and turn the AMP encoder to select a different cab model, or turn to ● for no cab—see [“Effects Models” on page 23](#).

Press and hold the AMP encoder to Save the current preset—see [“Working with Presets” on page 16](#).

- 3. Effects Knobs** Turn to select the desired effect model within each of the four effect categories, or turn entirely counterclockwise to bypass the effect category. See [“Selecting and Adjusting an Effect Model” on page 24](#).

TIP: Turn the DELAY knob (POD Express Guitar), DELAY VERB knob (POD Express Black), or MOD DELAY knob (POD Express Bass) fully clockwise to select the Looper —see [“Using the Looper” on page 27](#).

The silver colored label beneath the devices’ Amp and Effects knobs denotes the Amp model parameter that will be edited when holding ALT and turning the knob—see [“Editing Amp Parameters” on page 20](#).

4. ALT Button Press to access alternate features with the knobs or switches.

Press and hold the ALT button and press and release the TAP switch to enter the Global Settings. While in the Global Settings, press ALT to access additional settings—see [“Global Settings” on page 29](#).

Hold ALT and turn the AMP encoder and Effects knobs to adjust their corresponding amp parameters—see [“Editing Amp Parameters” on page 20](#).

Press and hold both the ALT button and the TAP switch while turning the AMP encoder to select a cab model (see [page 23](#)) or while turning a corresponding Effects knob to edit Noise Gate parameters (see [page 25](#)).

Press and hold both the ALT button and TAP switch while turning a corresponding Effects knob to adjust the amp’s Master Volume or Presence—see [page 21](#) for details.

5. ON Footswitch (FS1) and LED Press to enable or bypass the device. The LED lights white when enabled.

6. TAP Footswitch (FS2) and LED Press the TAP switch two or more times to set the tempo BPM (beats per minute) for Modulation and Delay effects. The LED flashes red to indicate the current tempo—see [“Setting the TAP Tempo” on page 18](#).

Press and hold the footswitch to display the Tuner—see [“Using the Tuner” on page 18](#).



TIP. The ON and TAP footswitches’ functions can optionally be changed to toggle all or individual effects categories on and off. Also, see [“Setting up an Expression Pedal and Footswitches” on page 14](#).

Preset Mode Switching

Press and hold both the ON and TAP switches to enter Preset Mode. You can then press-release the ON or TAP switches individually to scroll up/down through the device’s 21 preset locations. You can edit and overwrite any of the presets as desired—see [“Working with Presets” on page 16](#).

Rear Panel Jacks

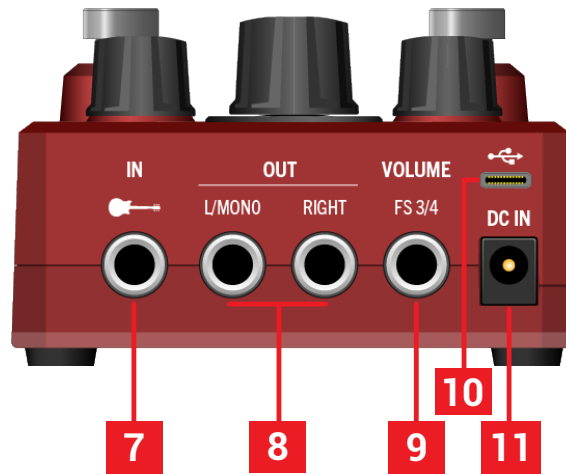

The rear panel connections
(all POD Express devices offer these same connections)

- 7. IN** Use an unbalanced 1/4" TS cable to connect your guitar, bass, or mono pedals to this input. If you're using batteries, your device powers on when a cable is connected here and powers off when disconnected.
- 8. OUT L/MONO, RIGHT** Use unbalanced 1/4" TS cables to connect to an external amplifier, mixing console, or into other pedals. When connecting to a mono amplifier or pedal, connect only the OUT - L/MONO jack.*

*NOTE: When only the OUT L/MONO jack is used, connecting headphones to the PHONES jack will change the OUT L/MONO signal to include only the left channel processed signal from stereo effects (MOD, DELAY, LOOPER, and REVERB type models). This may result in slight differences in the sound of these effect models. The PHONES signal remains unaffected.
- 9. VOLUME | FS 3/4** Connect an expression pedal to control Volume and/or a footswitch (or two footswitches) to control other features—["Setting up an Expression Pedal and Footswitches" on page 14.](#)

- 10. USB** Connect to your Mac or Windows computer's USB 2.0 (or faster) port or to a mobile device to use with the free ["POD Express Edit"](#) application, or to use your POD Express device as an audio interface.† (Note that USB hubs are not supported.)

†For mobile devices that do not include a USB-C® connector, a cable adapter is required, such as an Apple Camera Connect Kit for lightning-equipped iOS & iPadOS devices or a USB OTG adapter for Android devices. All adapters are sold separately. Please refer to your mobile device manufacturer's recommendations and instructions for connecting USB accessories.

- NOTE:** POD Express devices must be used with a USB cable that does not exceed 6.56 feet (2 meters) in length (sold separately).
POD Express devices function as "data only" USB devices—they cannot be powered via a USB connection.

- 11. DC IN** As an alternative to using batteries, connect a power adapter, such as the Line 6 DC-1g (sold separately). Power adapter requirements are 9VDC output voltage, center-negative (2.1mm center diameter), 500mA minimum current, and 4.5W minimum power.

POD Express Left Panel

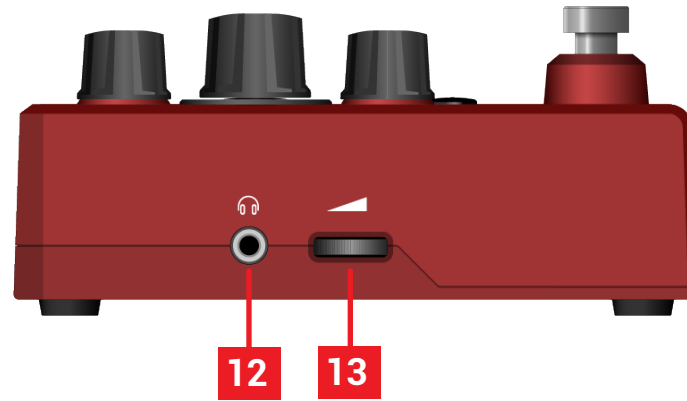

The left panel connections
(all POD Express devices offer these same left panel features)

12. PHONES Connect stereo headphones here; turn the VOLUME thumbwheel to adjust volume.

IMPORTANT! Always turn the VOLUME knob to minimum before connecting headphones. Protect your hearing!

NOTE: Disconnect PHONES when not in use to avoid draining batteries.

13. VOLUME Turn the thumbwheel to set the overall output level for the OUT & PHONES.

Quick Start

Installing Batteries

POD Express devices can be powered by three AA batteries (included). Please install the batteries as follows:

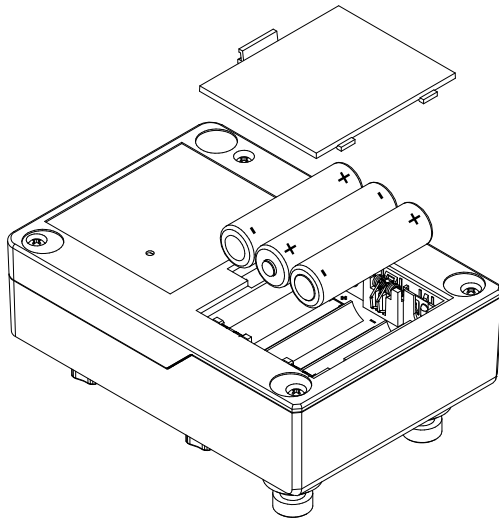

Installing batteries

- Disconnect all cables from your POD Express device.
- On the underside of the device, remove the battery compartment panel.
- Insert three AA batteries, taking care to match the positive (+) and negative (-) markings on each battery with the markings inside each battery slot.
- Replace the compartment panel securely.

NOTE: When using batteries, the device will automatically power on when you connect a cable into the IN jack. To power off the device, remove the cable from the IN jack. You should also be sure to disconnect PHONES to prevent draining batteries when the device is not in use. **Batteries should be removed when the device is not in use for long time periods.** Also, see "[Checking Remaining Battery Life](#)" on page 18.

TIP: Optionally, you can purchase the Line 6 DC-1g power adapter from the [Line 6 Online Shop](#) to power your POD Express device.

Installing the Adhesive Rubber Feet

To ensure best adhesion, please follow these steps for applying the included adhesive rubber feet to the bottom of your POD Express device.

- Clean the chassis surface where feet are to be applied with a mild solvent, such as isopropyl alcohol.
- Apply when chassis and environment are at or near room temperature (approx. 70° F / 21° C).
- Peel from backing and press and hold rubber feet firmly to the chassis for several seconds to apply. Avoid disturbing the rubber feet for up to 72 hours to allow for adhesive to fully bond.

Simple Setup

OK, no need to wait any longer—to follow is the quickest possible setup to get you up and running with your new POD Express device!

1. Turn the VOLUME thumbwheel all the way to minimum.

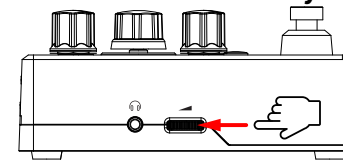

2. Use a standard instrument cable and connect your guitar or bass to the IN jack. Connect your headphones to the PHONES jack.

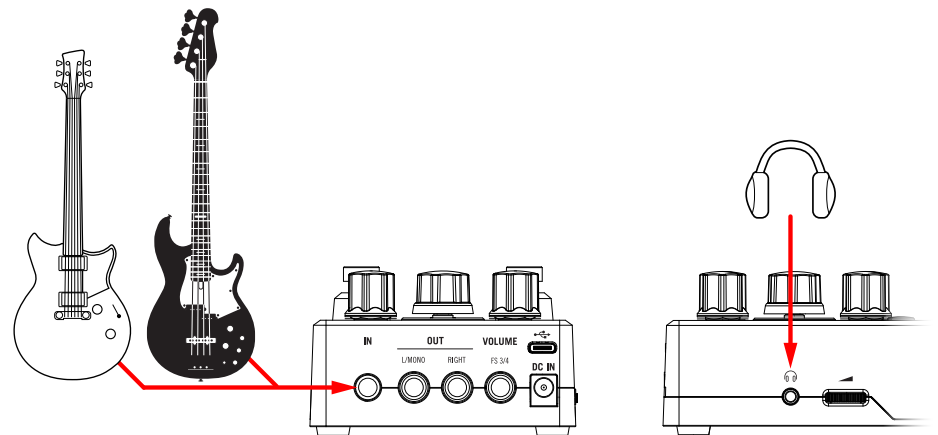

3. Play a note on your instrument and slowly turn up the VOLUME thumbwheel.

Now you're up and running! Try the following to explore more features.

Tune Up:

Press and hold the TAP switch to engage the Tuner.



Pluck a string and adjust your string until you see the LEDs surrounding the AMP encoder all lit green. Press any switch to exit the Tuner when done.

Try Some Presets:

Press and release both the ON and TAP footswitches together to enter Preset Mode. Turn the AMP encoder to load one of the factory presets.

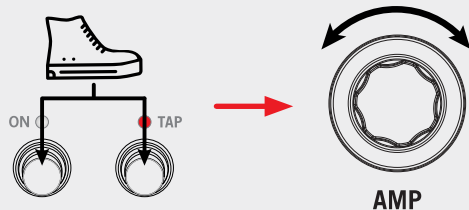

Once you have a preset you want to spend some time with or wish to edit, press both footswitches together to exit Preset Mode.

Try a Different Amp:

When not in Preset Mode, simply turn the AMP encoder to load one of the seven amps.



Try Some Effects:

Also, when not in Preset Mode, turn any Effects knob to enable one of its four models.



Turn the knob slowly to adjust the current effect's settings. Turn to minimum to bypass the effect.

Jam to Tracks:

Connect your POD Express device to the USB port of your computer or mobile device.

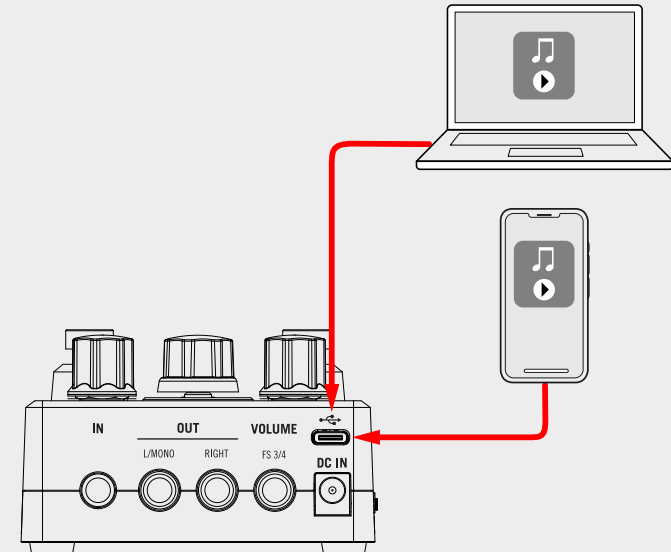

Configure your computer/mobile device to use POD Express/POD Express Bass as its main audio playback device.

Play your favorite tracks through your music player app to hear them through POD Express to jam along to your heart's content.

Congratulations, you're now a POD Express expert!
Stop here, plug in, and go practice.

Wait, you want more? Well, okay—POD Express does have quite a bit of additional hidden functionality that may not be immediately apparent. For example, did you know you can swap out cabs, control a hidden noise gate, connect an expression pedal or external switches, customize footswitch functions, use POD Express as a USB audio recording interface, and a lot more?

The rest of this manual digs pretty deep, so proceed at your own risk!

Features

Hooking It All Up

There are many ways to connect POD Express to other gear, and the following pages illustrate only a few. Before connecting, you should always turn the volumes to minimum on your POD Express device and any external amplifier or PA system.

In the Studio

POD Express devices include a multichannel USB audio interface for your production studio. It can *re-amp*, or use USB audio streams to process tracks or busses in your DAW (Digital Audio Workstation) after they're recorded. See "[USB Audio](#)" for more information.

NOTE: POD Express devices require batteries or a power adapter—they cannot be powered by USB.

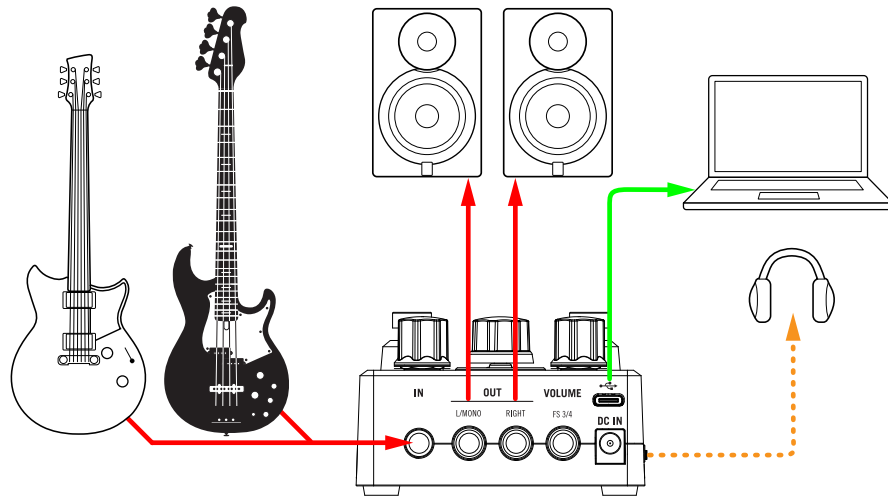

With an Amp or Powered Speakers

Depending on how complex your tones are, you can use POD Express as a multi-effects, looping, & tuner pedal into the front of a guitar or bass amp or as your entire processing rig, providing amp & cab modeling into a powered speaker unit (or two for stereo).

NOTE: If connecting to an amp (or to a powered speaker that offers speaker cab simulation) you may want to set your POD Express' Cab to "Off"—press and hold the ALT buttons and the TAP switch while turning the AMP encoder to ●. See "[Effects Models](#)" on page 23.

You can optionally connect other stompbox pedals before or after POD Express. For more control, add an expression pedal and/or external footswitch—or with a Y-cable, two footswitches—to the VOLUME | FS 3/4 jack. See "[Setting up an Expression Pedal and Footswitches](#)" on page 14.

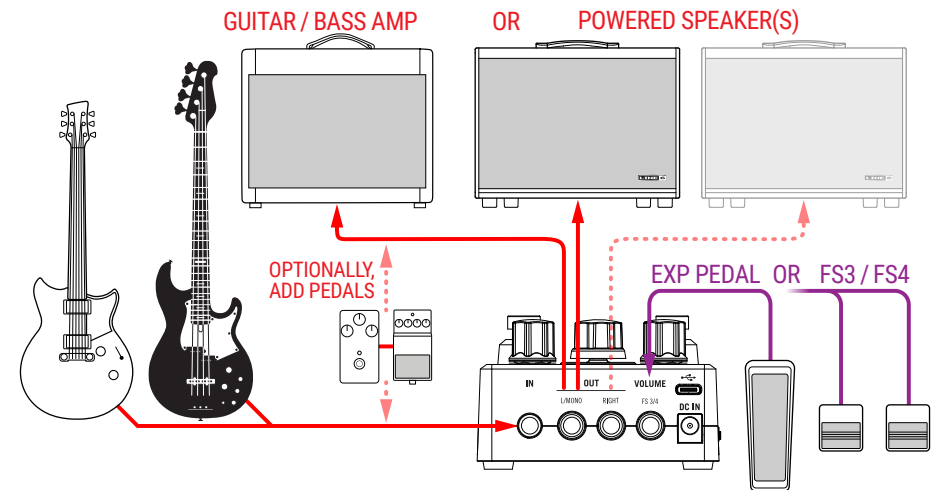

TIP: The Line 6 Powercab® series is specifically designed for use with today's modelers—and excellent for use with your POD Express! Please see line6.com/powercab for details.

With an Amp or P.A. System

POD Express is flexible enough to use as a multi-effects, looping, & tuner pedal into the front of a guitar or bass amp or as your entire processing rig, providing bass amp & cab modeling direct into a mixer/P.A. system.

NOTE: If connecting to a guitar or bass amp (or to a powered speaker that offers speaker cab simulation) you may want to set your POD Express' Amp and/or Cab to "Off":

To disable the Amp, turn the AMP encoder to ●.

To disable the Cab press and hold the ALT button and the TAP switch while turning the AMP encoder to ●.

Also, see ["Effects Models" on page 23](#).

You can optionally connect other stompbox pedals before or after POD Express. For more control, add an expression pedal and/or external footswitch—or with a Y-cable, two momentary type footswitches—to the VOLUME | FS 3/4 jack. See ["Setting up an Expression Pedal and Footswitches" on page 14](#).

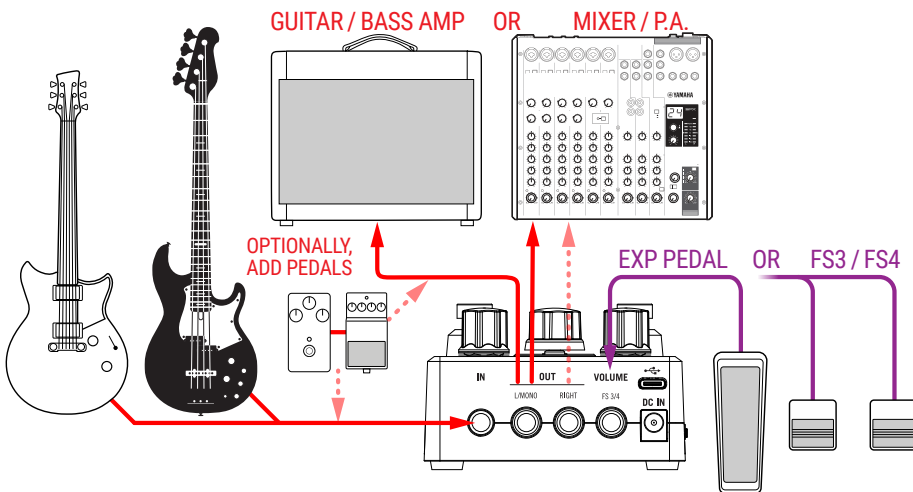

Setting up an Expression Pedal and Footswitches

You can connect an expression pedal to put it to use as a handy Volume pedal for your POD Express. The Volume block is located just after the Amp & Cab models, and before your time-based effects (also see ["About the Signal Path and Stereo Functionality" on page 23](#)).

Optionally, connect a footswitch (or two!) to toggle your device's "FS3" and/or "FS4" selectable options. Note that it is also required that you adjust the device's Global Settings options for your specific pedal/footswitch configuration, as indicated within the following examples.

NOTE: Expression pedal and footswitches are sold separately:

The Line 6 EXP-1 expression pedal is a fine choice (available from the [Line 6 Online Shop](#)), or most 3rd party expression pedals will work as well.

For single or dual external footswitches, you'll want to get the "momentary" (non-latching) type.

TS versus TRS Cable Types

First things first... In case you are not already familiar, you'll want to be able to identify the difference between these two types of 1/4" cable connections for your expression pedal or footswitches for our examples in this section:

- A Tip-Sleeve (TS) type cable consists of two conductors, the Tip (positive) and Sleeve (ground).
- A Tip-Ring-Sleeve (TRS) type cable consists of three conductors: the Tip (positive), Ring (positive), and Sleeve (ground).

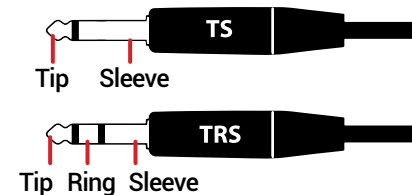

The VOLUME | FS3/4 jack on the rear of POD Express is a TRS type jack, into which you can connect a single expression pedal or single footswitch using a TS cable, or a dual-footswitch using a TRS cable. It is also possible to connect an expression pedal with a TS cable and a footswitch with a TS simultaneously, provided you connect them into a dual TS-to-TRS splitter (or "Y" adapter). Please see the following hookup examples.

Connecting an Expression Pedal

If you're connecting only an expression pedal, use a TS instrument cable and plug directly into the VOLUME | FS3/4 jack. The connected pedal will control the device's Volume block, from 0 to 100%.

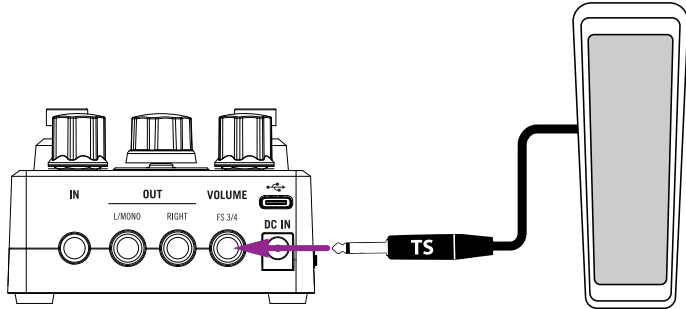

Connecting an expression pedal (TS cable connection)

You'll want to keep the ["Global Settings"](#) > Volume Jack parameter to its default "Volume (expression pedal)" setting.

NOTE: If no pedal is connected, the Volume block will default to 100%.

Connecting a Single Footswitch

If you're connecting a single footswitch, use a TS instrument cable and plug directly into the VOLUME | FS3/4 jack. The connected footswitch will control FS3.

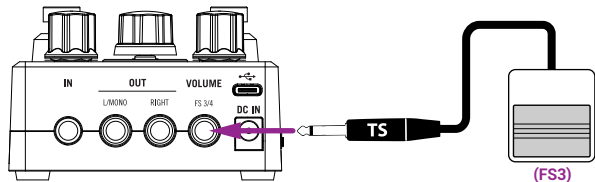

Connecting an expression pedal (TS cable connection)

You'll need to set the ["Global Settings"](#) > Volume Jack parameter to the "FS 3/4" option, and set the FS3 Assign parameter to whatever function you want your connected footswitch to perform (by default, the FS3 switch is set for the "Previous Preset" function).

Connecting an Expression Pedal and Footswitch

Use a dual TS-to-TRS splitter and plug into the VOLUME | FS3/4 jack. Your expression pedal should connect to the "Tip" and the footswitch to the "Ring" leads of the splitter.

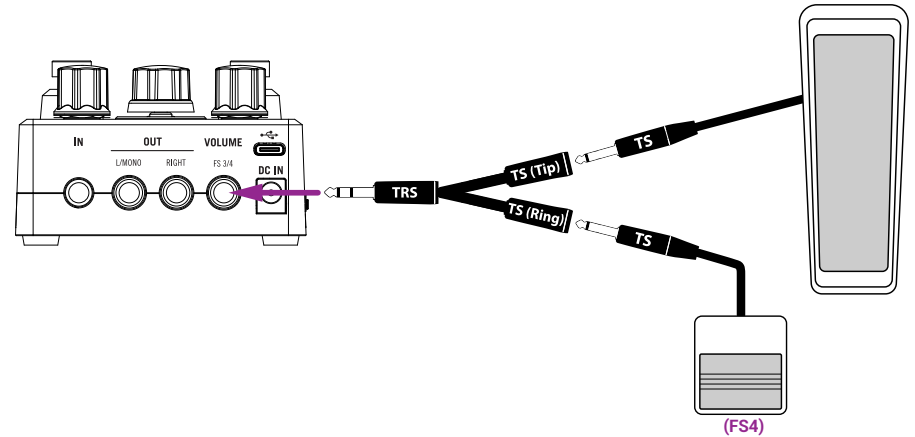

Connecting an expression pedal and footswitch (dual TS-to-TRS splitter)

You'll want to keep the ["Global Settings"](#) > Volume Jack parameter to its default "Volume/FS4" option, and set the FS4 Assign parameter to whatever function you want your "Ring-connected" footswitch to perform (by default, the FS4 switch is set for the "Next Preset" function). Your "Tip-connected" pedal will control the Volume.

Connecting Two Footswitches

Connecting Two Footswitches

You can achieve this type of setup using either two individual footswitches (each of which typically utilizes a TS cable) or a dual-footswitch unit (which typically utilizes a TRS cable).

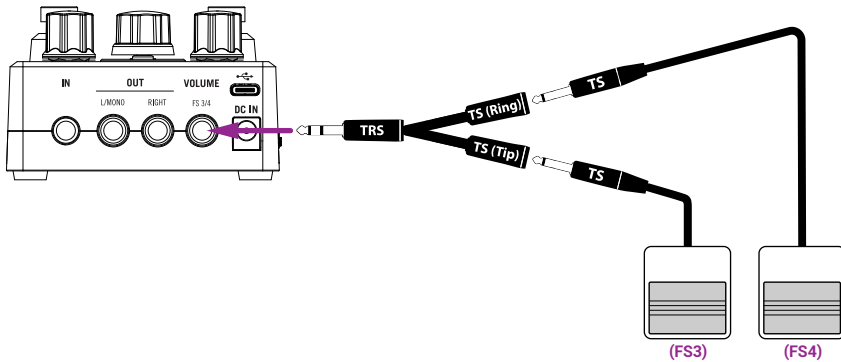

Connecting two footswitches (dual TS-to-TRS splitter)

Connecting a Dual Footswitch

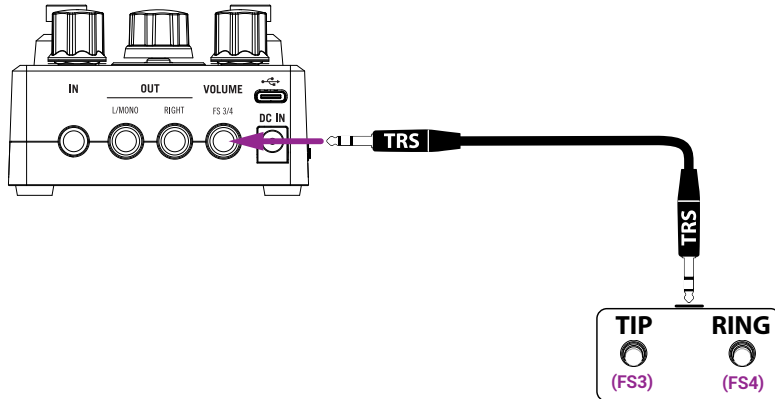

Connecting a dual footswitch (TRS to TRS cable)

When connecting two separate footswitches or a dual footswitch, you'll need to set the ["Global Settings"](#) > Volume Jack parameter to the "FS3/4" option. By default, FS3 is set for "Previous Preset" and FS4 for the "Next Preset" function—to change these functions you can use the Global Settings > FS3 Assign and FS4 Assign parameters.

Configuring Footswitch Functions

Enter the ["Global Settings"](#) and choose the corresponding "Assign" parameter for the ON (FS1), TAP (FS2), FS3, or FS4 footswitches to independently select the desired function.

- Set any footswitch to switch the assigned parameter as On/Off.
- A footswitch connected as FS3 or FS4 can also be assigned to control TAP Tempo or function as a Next or Previous Preset switch.

Working with Presets

Selecting and tweaking an amp, cab, or effect is all well and good, but saving presets with all your model settings makes recalling your favorite sounds even easier! POD Express devices include 21 preset memory locations, with Factory Presets loaded within locations 1~7 to get you started. All preset locations can be edited and overwritten with your own settings.

Selecting and Loading Presets

To Select and Load a Preset:

1. Press and hold both the ON and TAP switches for one second to enter Preset Select Mode.

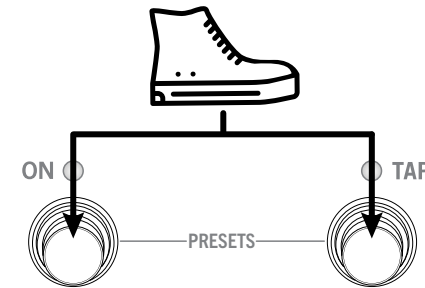

The footswitch LEDs go dark and you'll see the corresponding LED ring segment illuminate to indicate the current preset. Preset selection is indicated by the position and color of the LED segment around the AMP encoder. When you select a preset, you'll see its respective, individual LED segment illuminate, as detailed in the following steps.

2. Turn the AMP encoder clockwise or press TAP to select (or queue) the next preset; the next LED ring segment is lit.
3. Turn the AMP encoder counterclockwise or press ON to select the previous preset; the previous LED ring segment is lit.

Choosing the next preset while preset 21 is loaded will cycle around to load (or queue) preset 1. Likewise, choosing the previous preset while preset 1 is loaded will cycle to preset 21. Your selected preset will be indicated by the respective LED ring segment position and color.

POD Express Guitar - The preset numbers correspond to the LED segments as indicated below, with the LED lit white for presets 1~7, yellow for 8~14, or purple for 15~21.

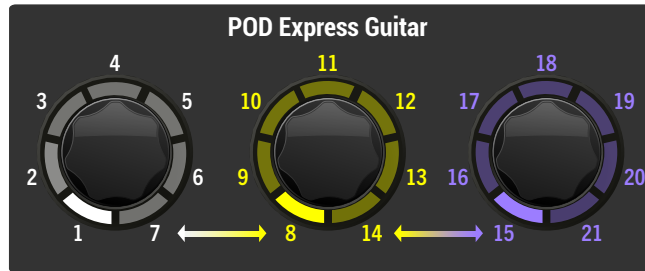

POD Express Black - The preset numbers correspond to the LED segments as indicated below, with the LED lit white for presets 1~7, aqua for 8~14, or purple for 15~21.

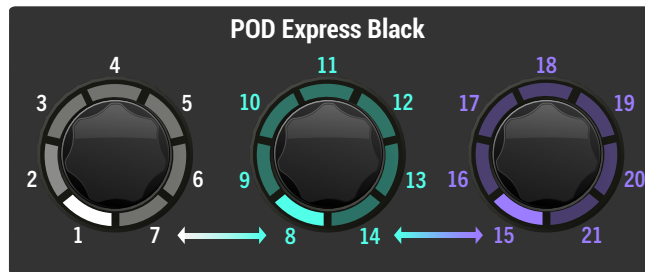

POD Express Bass - The preset numbers correspond to the LED segments as indicated below, with the LED lit white for presets 1~7, aqua for 8~14, or dark orange for 15~21.



There are two behaviors available for loading presets—**Instant** or **Load**—which are selectable via the [“Global Settings”](#) > Preset Select option.

- **Instant**, the default setting, immediately loads the next or previous preset once it is selected. Press both footswitches together to exit Preset mode.
- **Load** queues the selected preset only—you’ll see the selected preset’s LED flash to indicate the preset is queued. The preset is loaded once you press both ON and TAP, which then also exits the Preset Select Mode. This allows you to scroll through several presets to select your target preset without audibly loading every preset along the way.

TIP: You can also connect and configure external footswitches (FS3 and FS4) to be dedicated to loading the next/previous presets instantly. Further, you can custom assign the ON and TAP switches for other tasks—see [“Configuring Footswitch Functions”](#) on page 16.

Saving Your Preset

Once you’ve tweaked the amp, cab, and effects settings for the currently loaded preset to your liking, you’ll probably want to Save it as your own preset, either overwriting the current preset, or into a different one of the preset locations.

TIP: You can also use the POD Express Edit app to more easily save and manage presets, as well as to save a virtually unlimited number of presets to your computer or mobile device—see [page 41](#).

1. **Press and hold the AMP encoder to enter the Save mode. Both switch LEDs go dark and the current preset’s LED flashes.**
2. **If you want to save the preset to a different location, turn the AMP encoder to select a different preset location, as indicated by the AMP encoder’s LED position and color (see preceding section).** If you wish to exit without saving, press both the ON and TAP switches together to cancel.
3. **Press the AMP encoder to Save. The preset indicator LED flashes quickly twice.**

Setting the TAP Tempo

Tap in a beat (quarter notes) on the TAP switch to set a tap tempo, from 20 to 240 BPM, to which your modulation and delay effects can sync for their rate and repeats.*

***NOTE:** The POD Express Black Modulation models' modulation speeds are not synced to the TAP tempo, and will change speed as you adjust the MOD knob. You can use POD Express Edit to enable Sync if desired—see [“POD Express Edit” on page 39](#).

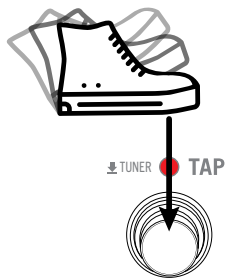

You'll see the TAP switch's LED flash to indicate your TAP tempo rate. Note that you can set the [“Global Settings”](#) - Tap Tempo option to choose whether your BPM is saved individually **Per Preset** or **Globally**.

Using the Tuner

A handy chromatic tuner is included in POD Express devices. The tuner will detect your individual string's tuning, which is displayed as flat, in tune, or sharp, relative to the nearest semitone.

Press and hold the TAP switch for 1 second to enter Tuner mode.

When in Tuner mode, the OUT and PHONES jacks are muted.

4. Pluck an individual string on your instrument and watch the LED ring segment for flat/sharp indication.

When all the LEDs are lit green, your string is in tune. The further left or right of center that the individual LED ring segments light up yellow to red, the more flat or sharp your string is from the target pitch, as shown below.



The LED ring segments light to indicate the tuning status of your string

5. To exit the Tuner, press any footswitch.

Checking Remaining Battery Life

With batteries in use within your POD Express device (and no power adapter connected), connect a 1/4" cable to the IN jack and wait for the device to fully power on. Press and hold the ALT button for 3 seconds to enter the battery check mode. While ALT is held, the LEDs will light to one of the following states to indicate the approximate remaining run time for the batteries.

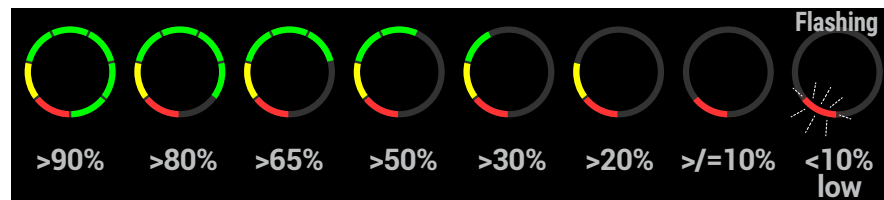

The remaining battery life LED indicator states

The LED Ring will remain lit solidly with the above indications until you release the ALT button, with the exception of the battery low state, where the LED 1 will persist flashing until the device is powered off.

Auto Low Battery Indication

The POD Express device will automatically detect when battery power drops to a low level, and will display the red flashing LED 1, as shown in the preceding image. This red flashing indicator will persist between other editing LED indicators until the device is powered off. Batteries should be replaced when indicated as low.

Amp & Cab Models

POD Express devices each include 7 Amp and 7 Cab models derived from the award-winning HX family of processors. The Amp & Cab models are accessed via the AMP encoder, with its LED ring indicating model selection and parameter edit values. It's really just as simple as turning the AMP encoder to choose your desired amp and a matching speaker cab is automatically loaded. You can also tweak amp parameters to taste, as covered within this chapter.

NOTE: All Amp & Cab models are mono—but you can utilize your device's Mod, Delay, and Reverb effects to create huge stereo soundscapes! See ["About the Signal Path and Stereo Functionality"](#) on page 23.

Selecting an Amp Model

The seven amp models are labeled in red and selectable via the AMP encoder. The corresponding LED ring segment (1-7) lights red to indicate your selected model as you turn the encoder. To bypass the amp, set the knob to the ● (OFF) position. For example, when the Clean amp model is selected, the position 1 segment is lit red.

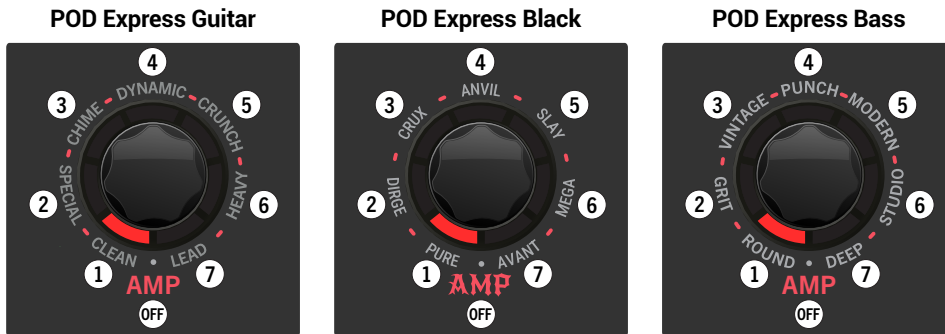

The CLEAN guitar amp is selected

The PURE guitar amp is selected

The ROUND bass amp is selected

The amp models and the classic amps on which they are based are listed in the following tables.

POD Express Guitar - Amp Models

Position	Type	Based On*
①	CLEAN	Fender® Princeton Reverb®
②	SPECIAL	Line 6 Litigator
③	CHIME	Matchless® DC30 (Channel 1, clean)
④	DYNAMIC	Ben Adrian Cartographer
⑤	CRUNCH	Friedman® BE-100 (BE/HBE channel)
⑥	HEAVY	Line 6 Oblivion
⑦	LEAD	Peavey® 5150®
⓪	OFF	N/A

POD Express Black - Amp Models

Position	Type	Based On*
①	PURE	Paul Reed Smith® Archon® (Clean channel)
②	DIRGE	Sunn® Model T (Brite channel)
③	CRUX	Orange® Rockerverb 100 MkIII (Dirty channel)
④	ANVIL	Line 6 Badonk
⑤	SLAY	Paul Reed Smith Archon (Lead channel)
⑥	MEGA	Diezel® VH4 (Mega channel)
⑦	AVANT	Revv® Generator 120 (Red/High Gain channel)
⓪	OFF	N/A

*See ["U.S. Registered Trademarks"](#) on page 28. All product names used in this document are trademarks of their respective owners and neither Yamaha Guitar Group nor Line 6 are associated or affiliated with them. These trademarks appear solely to identify products whose tones and sounds were studied by Line 6 during sound model development.

POD Express Bass - Amp Models

Position	Type	Based On*
①	ROUND	Ampeg® B-15NF Portaflex®
②	GRIT	Ampeg SVT® (Normal channel)
③	VINTAGE	Fender® Bassman® Silver Panel
④	PUNCH	Gallien-Krueger® GK 800RB
⑤	MODERN	Darkglass® Electronics Microtubes® B7K Ultra
⑥	STUDIO	Aguilar® Tone Hammer
⑦	DEEP	MESA/Boogie® M9 Carbine
OFF	OFF	N/A

Editing Amp Parameters

Note that each of the four Effects knobs and the AMP encoder include a lower label in silver. Each silver label specifies an amp parameter that can be adjusted as an alternate function by the corresponding knob or encoder.



The silver labels on all POD Express devices indicate amp parameters

Amp Parameters

Parameter	Description
GAIN	Adjusts the amount of distortion.
MID	Adjusts the amount of midrange.*
BASS	Adjusts the amount of low end.
TREBLE	Adjusts the amount of high end.
CH VOL	Adjusts the amp output volume.

*NOTE: For the POD Express Guitar - **Chime** amp model, the device's MID control adjusts the Cut parameter. This follows the actual knob design of the Matchless DC30 amp we modeled.

To access any of the above amp parameters, hold the ALT button while turning its respective Effects knob or AMP encoder.

As you adjust the knob, you'll see the LED ring segments light up bright red in clockwise fashion, with no LED segments lit to indicate the minimum value and up to all seven segments lit brightly to indicate the maximum value for the parameter.

For example, holding ALT while adjusting the GAIN (DIST) knob to approximately 50% results in about half of the LED ring segments lighting, clockwise from minimum, as shown in the following illustration.

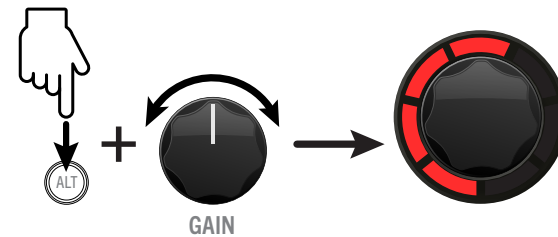

Editing an amp parameter (GAIN depicted)

TIP: Optionally, you can configure the Global Settings - "[Knob Function](#)" to change the behavior of the four Effects knobs so that they adjust the Amp's GAIN, MID, BASS, and TREBLE by default (and holding ALT while turning the knobs adjusts the effect model).

*See "U.S. Registered Trademarks" on page 28. All product names used in this document are trademarks of their respective owners and neither Yamaha Guitar Group nor Line 6 are associated or affiliated with them. These trademarks appear solely to identify products whose tones and sounds were studied by Line 6 during sound model development.

Amp Master Volume and Presence/Hi-Mid Parameters

Additionally, power amp section Master Volume and Presence (POD Express Guitar & POD Express Black) and Hi-Mid (POD Express Bass) are editable.

1. To access the amp's Master Volume, press and hold both the ALT button and TAP switch while turning the DELAY knob (POD Express Guitar), MOD knob (POD Express Black), or DIST knob (POD Express Bass).
2. To access the amp's Presence or Hi-Mid parameter, press and hold both the ALT button and TAP switch while turning the REVERB knob (POD Express Guitar), DELAY VERB knob (POD Express Black), or MOD DELAY knob (POD Express Bass).

As you adjust the knob, you'll see the LED ring with no LED segments lit to indicate the minimum value and up to all seven segments lit bright red to indicate the maximum value for the Master Volume or Presence/Hi-Mid parameter.*

***NOTE:** For the POD Express Bass device's **Grit**, **Vintage**, and **Studio** bass amps, Midrange Frequency and Bright parameters are available rather than Hi-Mid via the MOD DELAY knob. Please refer to the next step.

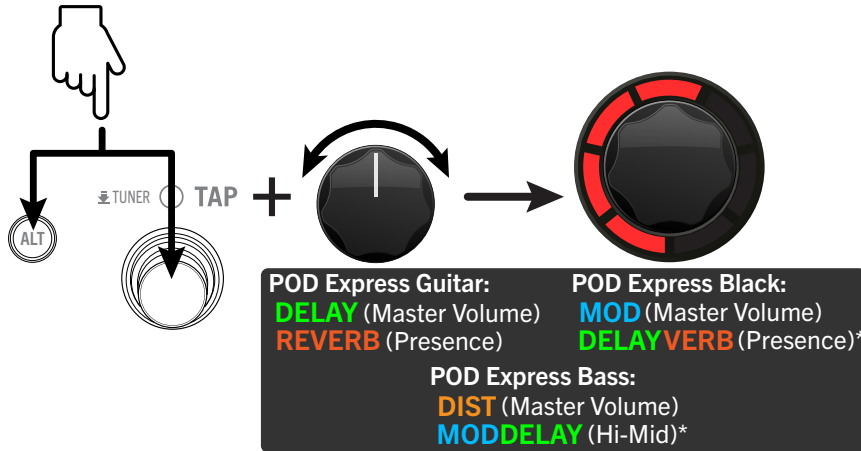

Editing the amp's Master Volume and Presence/Hi-Mid parameters

*Since the actual amplifiers modeled offer varying parameter options, we've mapped some parameters differently for when you hold ALT + the TAP switch and turn the POD Express Black's DELAY VERB knob or the POD Express Bass' MOD DELAY knob, as follows:

- For the **Black - Crux amp**, the modeled amplifier (Orange Rockerverb 100 MkIII) offers no Presence parameter, therefore, no parameter is adjusted.

- For the **Bass - Grit amp**, this sets the Midrange Frequency, for which the amp's Mid (ALT + Synth knob) parameter will boost or cut. You'll see three settings indicated via the amp ring's red LEDs as you turn the MOD DELAY knob: all LEDs off at minimum (220 Hz), the first four LEDs lit (800 Hz), and all LEDs lit at maximum (3000 Hz).
- For the **Bass - Vintage amp**, this adjusts the Bright switch. You'll see two settings available: all LEDs off at minimum (Bright Off) and all LEDs lit (Bright On).
- For the **Bass - Studio amp**, this sets the Midrange Frequency, for which the amp's Mid (ALT + Synth knob) parameter will boost or cut. You'll see the amp ring LEDs indicate the selected frequency as you turn the MOD DELAY knob: from all LEDs off (150 Hz) up to all seven LEDs lit bright red (1000 Hz).

Speaker Cab Models

As mentioned earlier, anytime an Amp model is selected, a matched default Speaker Cabinet model is automatically loaded. Please refer to the following Cab Model tables for the LED position that refers to each Amp model and its respective matched Cab model. You can optionally select a different Cab for your current Amp as well.

Selecting a Cab Model

For any Amp model, you can optionally change the Cab model to any of the seven included Cabs, or turn the knob to "Off" (no pink LED is lit) for no cab.* Changing cabs can provide a variety of available tones for the current Amp model!

***TIP:** You can choose "Off" for no Cab model if you plan on sending your device output to an external amplifier or into a Cab simulator/IR loader.

Press and hold both the ALT button and TAP footswitch while turning the AMP encoder to select a Cab.

You'll see one of the LED ring segments light pink to indicate the selected Cab model, as listed in the preceding tables.

In the example below, the position 3 pink LED segment is lit, indicating that the "2x12 Matchless" (POD Express Guitar) or "2x15 Fender" (POD Express Bass) Cab model is selected.

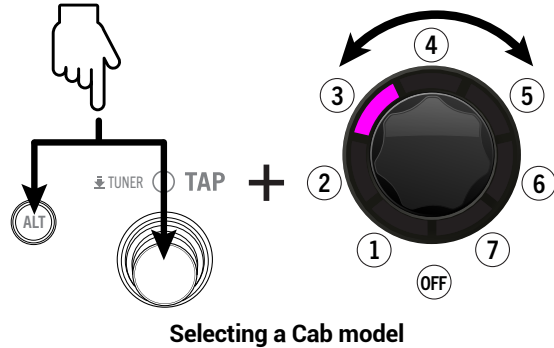

TIP: At any time, you can press and hold the ALT button and TAP switch together and see the pink LED illuminate to indicate the current Cab model in use.

POD Express Guitar Cab Models

Position	Matched to Amp	Based On*
①	CLEAN	1x10" Fender Princeton Reverb
②	SPECIAL	1x12" Fender Deluxe® Oxford
③	CHIME	2x12" Matchless DC-30, G12H30
④	DYNAMIC	4x12" Bogner® Überkab, V30
⑤	CRUNCH	4x12" Marshall® Basketweave, G12-M25
⑥	HEAVY	4x12" ENGL® XXL, V30
⑦	LEAD	4x12" MESA/Boogie 4FB, V30
OFF	OFF	N/A

POD Express Black Cab Models

Position	Matched to Amp	Based On*
①	PURE	1x12" MESA/Boogie® Extension, EVM12L
②	DIRGE	4x12" Sunn, G12T-75
③	CRUX	2x12" Orange, V30
④	ANVIL	4x12" MESA/Boogie 4FB, V30
⑤	SLAY	4x12" Marshall Basketweave G12M-25
⑥	MEGA	4x12" Bogner Überkab, V30
⑦	AVANT	4x12" ENGL XXL, V30
OFF	OFF	N/A

POD Express Bass Cab Models

Position	Matched to Bass Amp	Based On*
①	ROUND	1x15" Ampeg B-15
②	GRIT	8x10" Ampeg SVT
③	VINTAGE	2x15" Fender Bassman, D130
④	PUNCH	4x10" Ampeg SVT 410HLF
⑤	MODERN	4x10" Eden D410XLT
⑥	STUDIO	1x12" Epifani® Ultralight
⑦	DEEP	6x10" MESA/Boogie PowerHouse®
OFF	OFF	N/A

*See "U.S. Registered Trademarks" on page 28. All product names used in this document are trademarks of their respective owners and neither Yamaha Guitar Group nor Line 6 are associated or affiliated with them. These trademarks appear solely to identify products whose tones and sounds were studied by Line 6 during sound model development.

Effects Models

POD Express devices include a variety of effects models derived from the award-winning HX family of processors, as well as from the classic DL4™ and “M” series stompboxes and processors. You can choose any model from each of the four Effects knobs for up to four simultaneous Effects to create your tone masterpieces, with plenty of parameter tweaking on tap! An input Noise Gate and an expression pedal-accessible Volume are also available on POD Express devices.

About the Signal Path and Stereo Functionality

First, it may be helpful to understand the signal path of your POD Express device to get the most out of its stereo effects. The device functions as a mono input - stereo output guitar/bass processor. It accepts the mono input from your instrument via the IN jack and outputs stereo when both the OUT Left and Right jacks are connected (assuming you've enabled stereo effects—as we'll discuss in this chapter). When only the OUT - L/MONO jack is connected (if no headphones are connected), the device's stereo output is folded to mono.

POD Express devices include several processing “blocks” within their signal path which embellish your input signal from dry and uninspiring to fully-baked performance glory. To follow is the signal path block order. Note that all effects “post” the Amp/Cab and Volume Pedal are stereo.

NOTE: The **GATE** effect's parameters are accessed via the ALT button—see [“Adjusting the Noise Gate” on page 24](#).
The **VOLUME** effect is controlled via a connected expression pedal—see [“Setting up an Expression Pedal and Footswitches” on page 14](#).

POD Express Guitar Signal Path

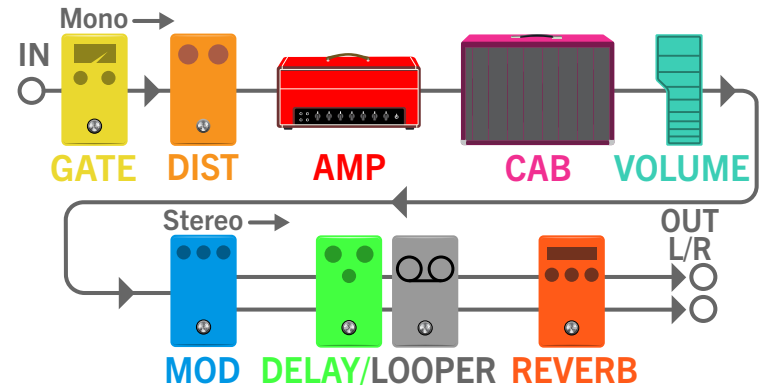

POD Express Black Signal Path

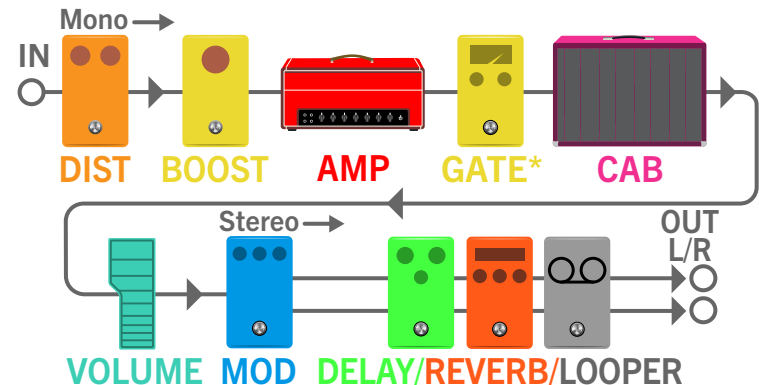

***NOTE:** For POD Express Black, the Gate's input is keyed from the device input, but the Gate block itself is positioned after the Amp within the signal path.

POD Express Bass Signal Path

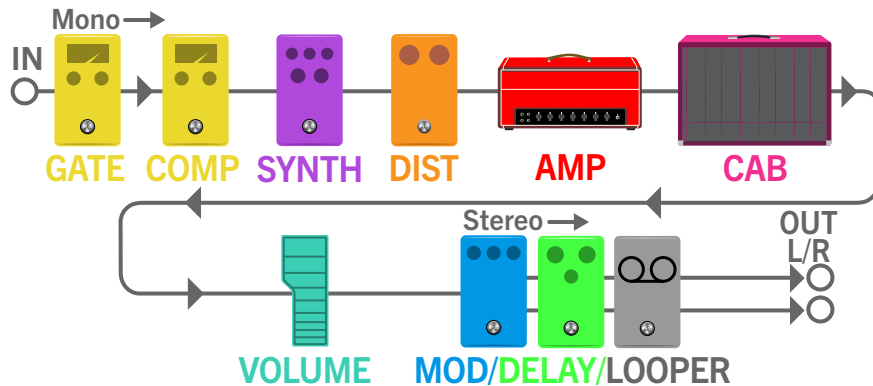

Selecting and Adjusting an Effect Model

All you need to do is turn one of the four Effects knobs to select a labeled model to put it into use, or turn the knob to fully counterclockwise for no effect. You can enable one effect on each of the four Effects category knobs simultaneously, providing a plethora of available tones and textures.

NOTE: The DELAY - LOOPER can be selected by turning the DELAY knob (POD Express Guitar) or MOD DELAY knob (POD Express Bass) fully clockwise to the Looper  symbol—see [“Using the Looper”](#) on page 27.

You'll see that each Effects knob is divided into four segments, with each of the four effect models offering a delineated, adjustable range.

Once you've selected an effect model, turn the Effects knob slowly within its indicated range to adjust the intensity of the model.

For example, turn the DIST knob within the OVERDRIVE model's range as pictured below. The intensity of the gain and saturation increases as you adjust the knob clockwise within the model's range.



Adjusting the Distortion - Overdrive effect model

Other effects' knobs and their models behave similarly as you turn the knob clockwise within its range: a MOD model increases its depth and rate, a DELAY increases its wet mix and number of repeats, a bass COMP increases its amount of compression, a REVERB increases its wet mix and decay time, etc.*

***TIP:** For the POD Express Bass - SYNTH effect models, turning the Effects knob clockwise within a model's range will increase its oscillation and/or resonance.

To bypass an effect, turn its knob all the way counterclockwise to the  symbol.



Turn an Effects knob fully counterclockwise to bypass the category

Adjusting the Noise Gate

POD Express devices include a Noise Gate at the input stage. This Gate does not appear on an Effects knob since it is always present—its Threshold and Decay parameters can be adjusted as follows.

1. To access the Gate's Threshold, press and hold both the ALT button and TAP switch while turning the DIST knob (POD Express Guitar, DIST knob (POD Express Black), or COMP knob (POD Express Bass)).

Setting the Threshold to its minimum value essentially bypasses the Gate.

2. To access the Gate's Decay, press and hold both the ALT button and TAP switch while turning the MOD knob (POD Express Guitar, BOOST knob (POD Express Black), or SYNTH knob (POD Express Bass)).

As you adjust the knob, you'll see the AMP encoder's LED ring with one yellow LED lit to indicate the minimum value, and up to all seven LEDs lit to indicate maximum value for the Threshold or Decay parameter adjustment.

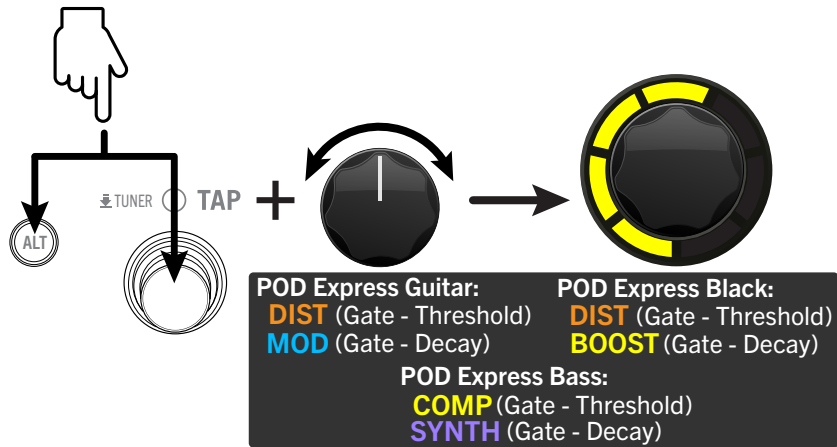

Editing the Gate parameters (POD Express Bass - Threshold depicted)

Gate Parameters

Parameter	Description
Threshold	Adjust to choose the signal level at which the gate "opens," to allow your signal through once your level exceeds the threshold, or "closes" to silence your signal once your signal dips below the threshold. The idea is to turn the threshold up just above any low level noise heard when not playing.
Decay	Adjust to determine how long it takes for the gate to "close" to silence the signal. Lower values set a shorter decay time, which can cut off sustaining notes. Higher values allow notes to sustain, but can also allow some unwanted noise through if set too high.

Accessing the Volume Pedal Effect

POD Express devices include a Volume Pedal effect. This Volume is accessed by connecting an optional expression pedal. Please see "[Connecting an Expression Pedal](#)" on page 15 for details.

POD Express Guitar Effects Models

To follow are all guitar effects models included on each of the Effects knobs on POD Express Guitar, including the actual effect unit upon which each is based.

Distortion Models

Type	Mono/Stereo	Based On*
BOOST	Mono	Klon® Centaur
OVERDRIVE	Mono	Ibanez® TS808 Tube Screamer®
DISTORTION	Mono	BOSS® DS-1 Distortion (Keeley modded)
FUZZ	Mono	'73 Electro-Harmonix® Ram's Head Big Muff Pi

Modulation Models

Type	Mono/Stereo	Based On*
CHORUS	Stereo	Modded Arion SCH-Z chorus
FLANGER	Stereo	MXR® 117 Flanger
PHASER	Stereo	MXR Phase 90
TREMOLO	Stereo	Fender optical tremolo circuit

Delay/Looper Models

Type	Mono/Stereo	Based On*
ANALOG	Stereo	BOSS DM-2 w/ Adrian Mod
DIGITAL	Stereo	Line 6 Original
TAPE	Stereo	Maestro® Echoplex® EP-3
PONG	Stereo	Line 6 Original (Ping Pong style)
LOOPER	Stereo	Line 6 Original (1 Switch Looper)

Reverb Models

Type	Mono/Stereo	Based On*
SPRING	Stereo	Line 6 Original
HALL	Stereo	Line 6 Original
PLATE	Stereo	Line 6 Original
SPACE	Stereo	Line 6 Original

*See "U.S. Registered Trademarks" on page 28. All product names used in this document are trademarks of their respective owners and neither Yamaha Guitar Group nor Line 6 are associated or affiliated with them. These trademarks appear solely to identify products whose tones and sounds were studied by Line 6 during sound model development.

POD Express Black Effects Models

To follow are all effects models included on each of the Effects knobs on POD Express Black, including the actual effect unit upon which each is based.

Distortion Models

Type	Mono/Stereo	Based On*
OPAMP	Mono	Fulltone® OCD
LED	Mono	Earthquaker Devices® Plumes (Mode 1 - LED)
DIST	Mono	Pro Co® RAT (with LM308 opamp)
FUZZ	Mono	Electro-Harmonix® Russian Big Muff Pi

Boost Models

Type	Mono/Stereo	Based On*
COMP	Mono	Ashly® CLX-52 (in conjunction w/ B. Sheehan)
MIDS	Mono	Ibanez® TS808 Tube Screamer®
DIRTY	Mono	Xotic® EP Booster
CLEAN	Mono	Earthquaker Devices Life - Boost circuit

Modulation Models

Type	Mono/Stereo	Based On*
CHORUS	Stereo	Line 6 Original (4-Voice Chorus)
FLANGER	Stereo	MicMix DynaFlanger
PHASER	Stereo	MXR Phase 90
TREMOLO	Stereo	BOSS PN-2

 **NOTE:** The POD Express Black Modulation models' modulation speeds are not synced to the TAP tempo (but you can use POD Express Edit to enable sync if desired—see “[POD Express Edit](#)” on page 39).

Delay/Verb/Looper Models

Type	Mono/Stereo	Based On*
- DELAY		
DIGITAL	Stereo	Line 6 Original (Vintage Digital)
TAPE	Stereo	Maestro Echoplex EP-3
- REVERB/LOOPER		
AMBIENCE	Stereo	Line 6 Original
HALL	Stereo	Line 6 Original
 LOOPER	Stereo	Line 6 Original (1 Switch Looper)

POD Express Bass Effects Models

To follow are all effects models included on each of the Effects knobs on POD Express Bass, including the actual effects unit upon which each is based.

Compressor Models

Type	Mono/Stereo	Based On*
OPTICAL	Mono	Ampeg Opto Comp
LA	Mono	Teletronix® LA-2A®
DELUXE	Mono	Line 6 Original
LIMITER	Mono	Ashly® CLX-52 (in conjunction w/ B. Sheehan)

Synth Models

Type	Mono/Stereo	Based On*
OCTAVE	Mono	BOSS OC-2 Octaver
GROWL	Mono	Line 6 Original
STRING	Mono	Roland® GR700 Guitar Synth
MUTANT	Mono	Musitronics® Mu-Tron III

*See “[U.S. Registered Trademarks](#)” on page 28. All product names used in this document are trademarks of their respective owners and neither Yamaha Guitar Group nor Line 6 are associated or affiliated with them. These trademarks appear solely to identify products whose tones and sounds were studied by Line 6 during sound model development.

Distortion Models

Type	Mono/Stereo	Based On*
BOOST	Mono	Xotic EP Booster
OVERDRIVE	Mono	Klon Centaur
DISTORTION	Mono	Tech 21 SansAmp Bass Driver DI V1
FUZZ	Mono	'73 Electro-Harmonix Ram's Head Big Muff Pi

Modulation/Delay/Looper Models

Type	Mono/Stereo	Based On*
- MODULATION		
CHORUS	Stereo	Modded Arion SCH-Z chorus
FLANGER	Stereo	MXR 117 Flanger
PHASER	Stereo	MXR Phase 90
- DELAY/LOOPER		
DIGITAL	Stereo	Line 6 Original
 LOOPER	Stereo	Line 6 Original (1 Switch Looper)

Using the Looper

Turn the DELAY knob (POD Express Guitar), DELAY VERB knob (POD Express Black), or MOD DELAY knob (POD Express Bass) fully clockwise to select the Looper. You'll see the ON switch LED lit dim white and the Amp encoder's LED ring lit dim red, letting you know the Looper is ready for recording.

Note that the Looper is stereo and positioned last within the device's signal path. This means that your recorded loops will include all the current active full amp, cab, and effects that you hear from your device's outputs. When playing back a loop, you can optionally change your amp & effects settings to provide a different tone for your instrument when playing along. You can record a loop of up to 30 seconds in length.

- 1. Press the ON switch to start recording.**
The ON switch LED and full LED Ring light bright red, indicating the loop is recording. Start playing your instrument immediately to record your loop.
- 2. Press the ON switch again to start loop playback.**
The ON switch LED lights bright green and the LED Ring segments light up bright green sequentially from one to all seven to indicate the duration of your recorded loop. You can jam along endlessly with your loop.
- 3. Press the ON switch again to overdub.**
The ON switch LED lights amber and the LED Ring segments light up amber sequentially to indicate the duration of your recorded loop for overdub mode. Play to embellish your loop with additional layered parts. Subsequent presses of the switch toggle between play and overdub mode.
- 4. While the Looper is in play or overdub mode, press and hold the ON switch for 1 second to "undo" the most recent overdub.**
The most recent overdub recording is undone. Holding the switch again will redo the recording.
- 5. Quickly double-press the ON switch to stop playback.**
Playback/recording stops and the LED ring lights dim green, indicating a loop is in memory. Note that your loop is cleared from memory whenever you exit Looper mode, change presets, power off the device, or manually clear the loop (see the next step).
- 6. While Looper playback/recording is stopped, press and hold the ON switch to completely delete your loop.**
The ON switch LED lights dim white and the LED Ring lights dim red to indicate no loop is currently in memory and it is ready for recording again.

*See "U.S. Registered Trademarks" on page 28. All product names used in this document are trademarks of their respective owners and neither Yamaha Guitar Group nor Line 6 are associated or affiliated with them. These trademarks appear solely to identify products whose tones and sounds were studied by Line 6 during sound model development.

U.S. Registered Trademarks

All product names used in this document are trademarks of their respective owners and neither Yamaha Guitar Group nor Line 6 are associated or affiliated with them. These trademarks appear solely to identify products whose tones and sounds were studied by Line 6 during sound model development.

5150 is a registered trademark of EVH Brands, LLC.

Aguilar is a registered trademark David Boonshoft.

Ashly is a registered trademark of Ashly Audio, Inc.

Bogner is a registered trademark of Bogner Amplification.

BOSS and Roland are registered trademarks of Roland Corporation U.S.

Darkglass and Microtubes are registered trademarks of Darkglass Electronics, TMI Douglas Castro.

Diezel is a registered trademark of Diezel GMBH.

DOD is a registered trademark of DOD Electronics Corporation.

Electro-Harmonix is a registered trademark of New Sensor Corp.

EarthQuaker Devices and Plumes are registered trademarks of EarthQuaker Devices, LLC.

Echoplex and MXR are registered trademarks of Dunlop Manufacturing, Inc.

Electro-Harmonix is a registered trademark of New Sensor Corp.

Engl is a registered trademark of Beate Ausflug and Edmund Engl

Epiphani is a registered trademark of Epifani Custom Sound Systems, Inc.

Fender, Bassman, Deluxe Reverb, Princeton Reverb, and Sunn are registered trademarks of Fender Musical Instruments Corp.

Friedman is a registered trademark of David Friedman (individual, USA).

Fulltone is a registered trademark of Fulltone Musical Products, Inc.

Gallien-Krueger is a registered trademark of Gallien Technology, Inc.

Ibanez and Tube Screamer are registered trademarks of Hoshino, Inc.

Klon is a registered trademark of Klon, LLC.

LA-2A and Teletronix are registered trademarks of Universal Audio, Inc.

Maestro is a registered trademark of Gibson Guitar Corp.

Marshall is a registered trademark of Marshall Amplification Plc.

Matchless is a registered trademark of Matchless, LLC.

MESA/Boogie, Lone Star, PowerHouse, and Rectifier are registered trademarks of Gibson, Inc.

Musitronics is a registered trademark of Mark S. Simonsen

Orange is a registered trademark of Orange Brand Services Limited.

Paul Reed Smith and Archon are registered trademarks of Paul Reed Smith Guitars, LP.

Pro Co is a registered trademark of Rapco International, Inc.

Peavey is a registered trademark of Peavey Electronics Corporation.

Revv is a registered trademark of Revv Amplification Inc.

Roland is a registered trademark of Roland Corporation.

Xotic is a registered trademark of Prosound Communications, Inc.

Global Settings

The Global Settings contain additional parameters that apply to all presets, such as input and output levels, footswitch configurations, etc. To access the Global Settings, use the following steps. Most likely, you'll only need to configure these Settings once to your liking and forget all about them! Note that the steps to edit Global Settings parameters are the same for POD Express devices. However, the footswitch parameters' selectable options differ slightly, as noted.

TIP: You can also configure all Global Settings easily using the POD Express Edit app—see [page 44](#).

1. Press and hold the ALT button and press the AMP encoder to enter Global Settings mode and display the first page of options.

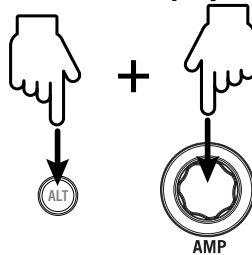

The seven LEDs that surround the AMP encoder light up with colors reflecting the current values of Global Settings 1-7 on the first page, as shown below.

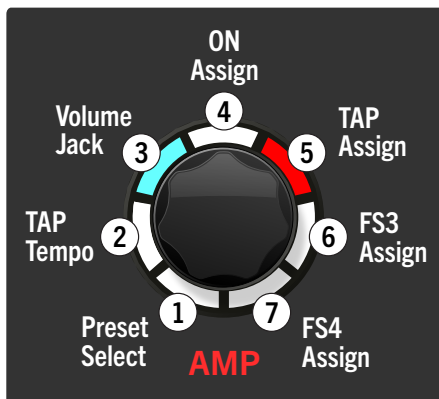

Page 1 of the Global Settings (1 - 7)

2. Turn the AMP encoder to select the Global Setting (1-7) you wish to edit and press the AMP encoder to cycle through available options. The color of the position's LED indicates the selected value.

See the ["Global Settings Table" on page 30](#) to reference the LED colors for each parameter's values.

As an example, if you want to configure the TAP Tempo setting as "Global" rather than the default "Per Preset" value, turn the AMP encoder to position 2 (its LED flashes), and press the AMP encoder until the LED turns aqua.

3. To access Global Settings 8-11 on page 2, press and release ALT.



After pressing ALT, you'll see the AMP encoder's first two LEDs light up with colors reflecting the current values of Global Setting 8 - 11. See the figure below for reference.

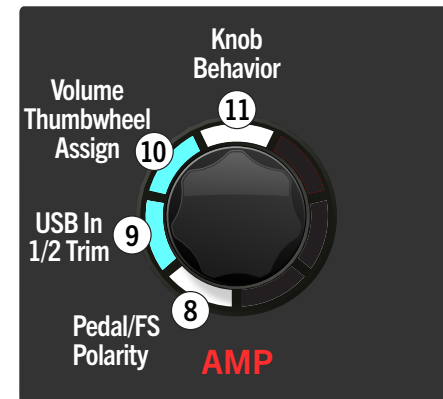

Page 2 of the Global Settings (8 - 11)

4. Turn the AMP encoder to select Global Setting (8 -11) and press AMP to cycle through the available options.

See the ["Global Settings Table" on page 30](#) to reference the parameter values' LED colors.



























5. When finished editing, press either footswitch to exit the Global Settings.

Global Settings Table























The LED colors are as follows:



(white),
 (red),
 (aqua),
 (light orange),
 (blue),
 (green),
 (dark orange),
 (purple),
 (yellow)





Position	Parameter	LED Color - Value ✔ Indicates the factory default setting	Description
1	Preset Select	 All Instant ✔	Configure the behavior for preset loading while in Preset Mode (see “Working with Presets” on page 16). When pressing TAP or ON, (or turning the AMP encoder) the next/previous preset is immediately loaded.
		 Load On/Off	Pressing TAP or ON (or turning the AMP encoder) queues the selected preset, and then pressing both the TAP and ON switches loads the queued preset
2	TAP Tempo	 Per Preset ✔	Choose whether the TAP Tempo is applied per preset or globally. The TAP Tempo rate is applied and saved individually, per preset.
		 Global	The TAP Tempo is applied globally.
3	Volume Jack	 FS3/FS4 (switches)	Configure the Volume jack to connect a single (or dual) footswitch or to connect an expression pedal (or an expression pedal and a footswitch). Use the FS3 Assign and FS4 Assign global settings to choose the function for each switch.
		 Volume/FS4 (expression pedal/switch) ✔	Configure the jack for connecting a single or dual footswitch. Configure the jack for connecting an expression pedal (and, optionally, an external footswitch). The expression pedal will control the Volume and switch will control FS4.
4	ON Assign 	 All On/Off ✔	Configure the function of the POD Express Guitar ON footswitch behavior. Enable or disable the device—when Off, this disables all processing.
		 Effects On/Off	Enable or disable all effects (Noise Gate, Distortion, Modulation, Delay, Reverb, and Volume).
		 Distortion On/Off	Enable or disable the Distortion effect.
		 Modulation On/Off	Enable or disable the Modulation effect.
		 Delay On/Off	Enable or disable the Delay effect.
		 Reverb On/Off	Enable or disable the Reverb effect.

Position	Parameter	LED Color - Value	Description
		✔ Indicates the factory default setting	
4		ON Assign	Configure the function of the POD Express Guitar ON footswitch behavior.
		 All On/Off ✔  Effects On/Off	Enable or disable the device—when Off, this disables all processing. Enable or disable all effects (Noise Gate, Distortion, Boost, Modulation, Delay/Verb, and Volume).
		 Distortion On/Off	Enable or disable the Distortion effect.
		 Boost On/Off	Enable or disable the Boost effect.
		 Modulation On/Off	Enable or disable the Modulation effect.
		 Delay/Verb On/Off	Enable or disable the Delay/Verb effect.
4		ON Assign	Configure the function of the POD Express Bass ON footswitch behavior.
		 All On/Off ✔  Effects On/Off	Enable or disable the amp, cab, and all effect models. Enable or disable all effects (Noise Gate, Compressor, Synth, Distortion, Modulation/Delay, and Volume).
		 Compressor On/Off	Enable or disable the Compressor effect.
		 Synth On/Off	Enable or disable the Synth effect.
		 Distortion On/Off	Enable or disable the Distortion effect.
		 Modulation/Delay On/Off	Enable or disable the Modulation/Delay effect.
5		TAP Assign	Configure the function for the POD Express Guitar TAP footswitch:
		 TAP/Tuner ✔  Effects On/Off	Tap the switch to enter the tempo. Press and hold to display the Tuner. Enable or disable effects (Distortion, Modulation, Delay, and Reverb).
		 Distortion On/Off	Enable or disable the Distortion effect.
		 Modulation On/Off	Enable or disable the Modulation effect.
		 Delay On/Off	Enable or disable the Delay effect.
		 Reverb On/Off	Enable or disable the Reverb effect.
5		TAP Assign	Configure the function for the POD Express Black TAP footswitch:
		 TAP/Tuner ✔  Effects On/Off	Tap the switch to enter the tempo. Press and hold to display the Tuner. Enable or disable effects (Distortion, Boost, Modulation, and Delay/Verb).
		 Distortion On/Off	Enable or disable the Distortion effect.
		 Boost On/Off	Enable or disable the Boost effect.
		 Modulation On/Off	Enable or disable the Modulation effect.
		 Delay/Verb On/Off	Enable or disable the Delay/Verb effect.

Position	Parameter	LED Color - Value	Description
		✔ Indicates the factory default setting	
5	TAP Assign 	<p>Red TAP/Tuner ✔</p> <p>Cyan Effects On/Off</p> <p>Yellow Compressor On/Off</p> <p>Purple Synth On/Off</p> <p>Orange Distortion On/Off</p> <p>Blue Modulation/Delay On/Off</p>	<p>Configure the function for the POD Express Bass TAP footswitch:</p> <p>Tap the switch to enter the tempo. Press and hold to display the Tuner.</p> <p>Enable or disable effects (Compressor, Synth, Distortion, and Modulation/Delay).</p> <p>Enable or disable the Compressor effect.</p> <p>Enable or disable the Synth effect.</p> <p>Enable or disable the Distortion effect.</p> <p>Enable or disable the Modulation/Delay effect.</p>
6	FS3 Assign 	<p>White Previous Preset ✔</p> <p>Red TAP/Tuner</p> <p>Cyan Effects On/Off</p> <p>Orange Distortion On/Off</p> <p>Blue Modulation On/Off</p> <p>Green Delay On/Off</p> <p>Red Reverb On/Off</p>	<p>Configure the function for the POD Express Guitar FS3 footswitch. (Note that the Volume Jack, position 3 global setting also determines your footswitch configuration.):</p> <p>Select the previous preset.</p> <p>Tap the switch to enter the tempo. Press and hold to display the Tuner.</p> <p>Enable or disable effects (Distortion, Modulation, Delay, and Reverb).</p> <p>Enable or disable the Distortion effect.</p> <p>Enable or disable the Modulation effect.</p> <p>Enable or disable the Delay effect.</p> <p>Enable or disable the Reverb effect.</p>
6	FS3 Assign 	<p>White Previous Preset ✔</p> <p>Red TAP/Tuner</p> <p>Cyan Effects On/Off</p> <p>Orange Distortion On/Off</p> <p>Yellow Boost On/Off</p> <p>Blue Modulation On/Off</p> <p>Green Delay/Verb On/Off</p>	<p>Configure the function for the POD Express Black FS3 footswitch. (Note that the Volume Jack, position 3 global setting also determines your footswitch configuration.):</p> <p>Select the previous preset.</p> <p>Tap the switch to enter the tempo. Press and hold to display the Tuner.</p> <p>Enable or disable effects (Distortion, Boost, Modulation, and Delay/Verb).</p> <p>Enable or disable the Distortion effect.</p> <p>Enable or disable the Boost effect.</p> <p>Enable or disable the Modulation effect.</p> <p>Enable or disable the Delay/Verb effect.</p>

Position	Parameter	LED Color - Value	Description
		✔ Indicates the factory default setting	
6	FS3 Assign 	<ul style="list-style-type: none">  Previous Preset ✔  TAP/Tuner  Effects On/Off  Compressor On/Off  Synth On/Off  Distortion On/Off  Modulation/Delay On/Off 	<p>Configure the function for the POD Express Bass FS3 footswitch. (Note that the Volume Jack, position 3 global setting also determines your footswitch configuration.):</p> <p>Select the previous preset.</p> <p>Tap the switch to enter the tempo. Press and hold to display the Tuner.</p> <p>Enable or disable effects (Compressor, Synth, Distortion, and Modulation/Delay).</p> <p>Enable or disable the Compressor effect.</p> <p>Enable or disable the Synth effect.</p> <p>Enable or disable the Distortion effect.</p> <p>Enable or disable the Modulation/Delay effect.</p>
7	FS4 Assign 	<ul style="list-style-type: none">  Next Preset ✔  TAP/Tuner  Effects On/Off  Distortion On/Off  Modulation On/Off  Delay On/Off  Reverb On/Off 	<p>Configure the function for the POD Express Guitar FS4 footswitch:</p> <p>Select the next preset.</p> <p>Tap the switch to enter the tempo. Press and hold to display the Tuner.</p> <p>Enable or disable effects (Distortion, Modulation, Delay, and Reverb).</p> <p>Enable or disable the Distortion effect.</p> <p>Enable or disable the Modulation effect.</p> <p>Enable or disable the Delay effect.</p> <p>Enable or disable the Reverb effect.</p>
7	FS4 Assign 	<ul style="list-style-type: none">  Next Preset ✔  TAP/Tuner  Effects On/Off  Distortion On/Off  Boost On/Off  Modulation On/Off  Delay/Verb On/Off 	<p>Configure the function for the POD Express Black FS4 footswitch:</p> <p>Select the next preset.</p> <p>Tap the switch to enter the tempo. Press and hold to display the Tuner.</p> <p>Enable or disable effects (Distortion, Boost, Modulation, and Delay/Verb).</p> <p>Enable or disable the Distortion effect.</p> <p>Enable or disable the Boost effect.</p> <p>Enable or disable the Modulation effect.</p> <p>Enable or disable the Delay/Verb effect.</p>

Position	Parameter	LED Color - Value ✔ Indicates the factory default setting	Description
7	FS4 Assign 	<ul style="list-style-type: none">  Next Preset ✔  TAP/Tuner  Effects On/Off  Compressor On/Off  Synth On/Off  Distortion On/Off  Modulation/Delay On/Off 	<p>Configure the function for the POD Express Bass FS4 footswitch:</p> <p>Select the next preset.</p> <p>Tap the switch to enter the tempo. Press and hold to display the Tuner.</p> <p>Enable or disable all effects (Compressor, Synth, Distortion, and Modulation/Delay).</p> <p>Enable or disable the Compressor effect.</p> <p>Enable or disable the Synth effect.</p> <p>Enable or disable the Distortion effect.</p> <p>Enable or disable the Modulation/Delay effect.</p>
8	Pedal/FS Polarity	<ul style="list-style-type: none">  Normal ✔  Inverted 	<p>Configure the +/- polarity for your connected expression pedal or footswitch. If your pedal or footswitch is controlling parameters backward, try changing this setting.</p> <p>Set for Normal polarity.</p> <p>Set for Inverted polarity.</p>
9	USB In 1/2 Trim	<ul style="list-style-type: none">  +6.0 dB  +3.0 dB  0 dB ✔  -3.0 dB  -6.0 dB  -9.0 dB  -12.0 dB 	<p>Independently adjust the level of incoming USB 1/2 audio, such as when streaming from iTunes, Spotify, etc., to balance with your guitar or bass signal level for jamming along:</p> <p>Increase the level by 6.0 dB.</p> <p>Increase the level by 3.0 dB.</p> <p>No change applied to the level (unity gain).</p> <p>Decrease the level by 3.0 dB.</p> <p>Decrease the level by 6.0 dB.</p> <p>Decrease the level by 9.0 dB.</p> <p>Decrease the level by 12.0 dB.</p>
10	Volume Wheel Control	<ul style="list-style-type: none">  Headphone Outs only*  Headphone and Main 1/4" Outs ✔ 	<p>Configure whether the device's Volume thumbwheel controls the Headphone and Main 1/4" Outputs or only the Headphone Output levels:</p> <p>Set the Volume thumbwheel to only adjust the level of the Headphone output. The Main L/MONO and RIGHT 1/4" Output's level becomes fixed at maximum volume.*</p> <p>*IMPORTANT! To avoid potentially loud output levels, be sure to set your external amplifier or monitoring system to minimum volume before connecting to the POD Express device's Main 1/4" outputs when using this setting.</p> <p>Set the Volume thumbwheel to adjust the level of the Headphone and Main L/MONO and RIGHT 1/4" Outputs.</p>

Position	Parameter	LED Color - Value	Description
		 Indicates the factory default setting	
11	Knob Function	 FX Selection (hold ALT for Amp Parameter Editing) 	Configure what is controlled when turning any of the four FX knobs versus what is controlled when holding the ALT button while turning the knob: Turning an FX knob selects an effects model and adjusts its settings. Holding ALT while turning adjusts the knob's silver-labeled Amp parameter.
		 Amp Parameter Editing (hold ALT for FX Selection)	Turning an FX knob adjusts its silver-labeled Amp parameter. Holding ALT while turning selects an effects model and adjusts its settings.

Restoring All Global Settings

You can optionally perform a Factory Reset on your POD Express device to return all Global Settings to their factory defaults.

! **IMPORTANT!** Performing a Factory Reset will also restore all factory presets, erasing any custom presets you may have saved on your device. We highly recommend using the POD Express Edit app to create a backup of your device *before* performing a Factory Reset. Once the Factory Reset is completed, you can optionally use POD Express Edit to restore the backup to restore your previous presets and Global Settings.

Performing a Factory Reset

Start by powering POD Express off and disconnecting any USB cable. While holding both the ON and TAP footswitches, power on the device:

- If using batteries, connect a 1/4" cable into the device's IN jack to power on.
- If using a power adapter, connect the adapter to the DC IN to power on.

When powering on the device, you'll see all the AMP encoder's LEDs flash white briefly three times indicating the factory reset was successful.

USB Audio

POD Express devices function as USB 2.0, multichannel, low latency, audio interfaces, with native 24-bit/48 kHz audio support for Windows and macOS computers, as well as for iOS and Android mobile devices (see [page 8](#) for USB connectivity details). Refer to the illustration and tables below for a description of how audio is handled between POD Express and your computer.

NOTE: For low latency USB audio operation on Windows computers (required for most Windows DAW applications), you must first download and install the Line 6 POD Express ASIO® driver (see [page 38](#)).

For macOS computers and iOS or Android mobile devices, there is no Line 6 driver installation necessary—POD Express devices support the class compliant driver.

For details on driver support with the latest operating systems, please visit line6.com/support.

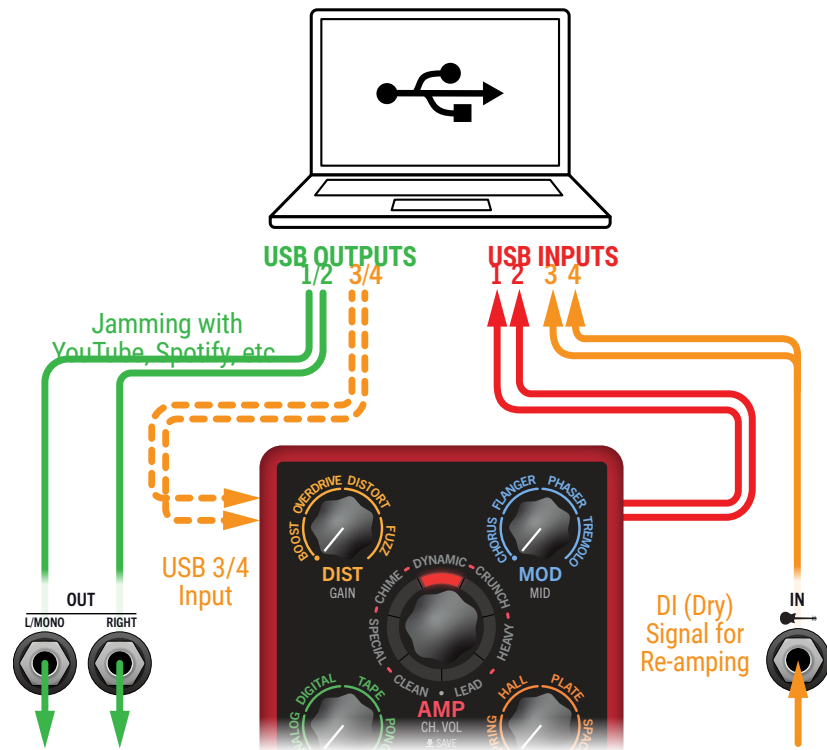

USB audio routing for POD Express devices

USB Input	Source
USB 1 and 2	Fully processed output from the POD Express device. These inputs may appear in your DAW software as RECORD (L) and RECORD (R) .
USB 3 and/or 4	DI (dry) output from the POD Express device (use to record an unprocessed signal for re-amping later). These inputs may appear in your DAW software as INPUT MON (L) and INPUT MON (R) .
USB Output	Destination
USB 1/2	POD Express device playback (direct, no processing) for monitoring your audio app's output or jamming along with YouTube™, Spotify, etc. These outputs may appear in your DAW software as JAM (L) and JAM (R) .
USB 3/4	POD Express device re-amping inputs (route the playback of your audio app's dry track here to re-amp it). These outputs may appear in your DAW software as RE-AMP (L) and RE-AMP (R) .

TIP: If you're jamming along with music via USB streaming, such as from a computer or mobile device app (iTunes, Spotify, etc.) to POD Express, you can independently adjust the level of the streaming USB audio, if necessary, using the "Global Settings" **USB In 1/2 Trim** option. This allows you to more easily balance the music playback volume versus the level of your guitar or bass signal.

Hardware Monitoring vs. Software Monitoring

POD Express devices provide *hardware monitoring*, which lets you hear your live input signal at all times, independent of your Digital Audio Workstation (DAW) software's monitor settings. Hardware monitoring can be desirable since it allows you to hear your live guitar with processing added and essentially "latency-free," since the monitor signal is not routed through your DAW software.

In some DAW recording scenarios, it may be preferable to utilize your recording application's "input monitoring" or "software monitoring" feature, which routes your live input signal through the armed recording track, thus allowing you to monitor the input processed by any plugins you may have inserted on the track. The one downside of DAW software monitoring, however, is that your live input signal will be delayed slightly due to being routed through the software and back to POD Express' outputs, which is referred to as "latency." POD Express is designed to provide very low latency operation—also, see ["ASIO Driver Settings \(Windows only\)"](#) for info and settings.

When a DAW track's software monitoring is active, you'll likely **not** want to simultaneously hear the processed POD Express hardware monitoring signal. To achieve this, it is best to use the POD Express USB 3/4 inputs as your DAW audio track's input source, and turn the POD Express' AMP - CH VOL parameter down to minimum (see "[Editing Amp Parameters](#)" on page 20). This configuration allows you to hear and record only the dry, DI signal from POD Express into your audio track. (See the next section for more on recording a DI track.)

DI Recording and Re-amping

A common DAW recording technique is to record a dry DI (Direct Input) signal, such as the unprocessed signal from your guitar or bass. This lets you process the DI track later with plugins (such as the [Helix Native plugin](#)), and/or "re-amp" the DI track through an amp or other outboard gear. POD Express devices have handy options built right in for recording DI tracks, as well as for easy re-amplification of DI tracks back through your own tones, all without extra hardware or cabling!

Your device offers two special DI outputs, USB Outs 3 and 4, which are fed directly from the guitar or bass IN.

Recording a Dry DI Track

For this example, we'll record guitar onto two DAW tracks simultaneously—one capturing the processed tone and the other the unprocessed (dry) DI guitar/bass.

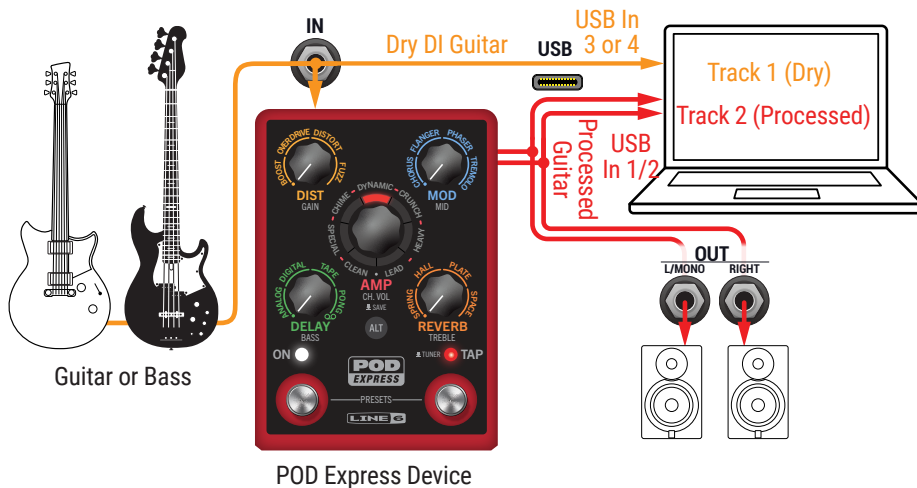

1. **Create two new audio tracks in your DAW software:**
Create one mono track to record the dry DI guitar, and set the track's input to POD Express USB 3 (or USB 4, it doesn't matter which).
Create one stereo track to record your full, stereo, processed tone and set the track's input to POD Express USB 1/2.
2. **Set both tracks' outputs, as well as the DAW Master output, to POD Express USB 1/2 to allow all tracks to play back through the device.**

The level of the POD Express (processed) USB 1/2 signal is affected by the AMP - CH VOL setting, therefore, you'll want to adjust this to optimize the recording level of the USB 1/2 track. (The dry USB 3/4 signal is a fixed level, unaffected by POD Express' volume or gain parameters.)

NOTE: Setting the stereo track's output to POD Express USB 1/2 allows you to hear your processed tone via POD Express' hardware monitoring while recording. For this configuration, disable software input monitoring on all DAW tracks.

3. **Arm both these DAW audio tracks, hit the Record button and start playing.**

Now you have your processed track to hear with the project, and a separate DI track with which you can further experiment at any time with DAW plugins and/or re-amping (see the next section).

Re-amping Through POD Express

Now let's take the dry DI track we recorded and route its playback back through POD Express for processing.

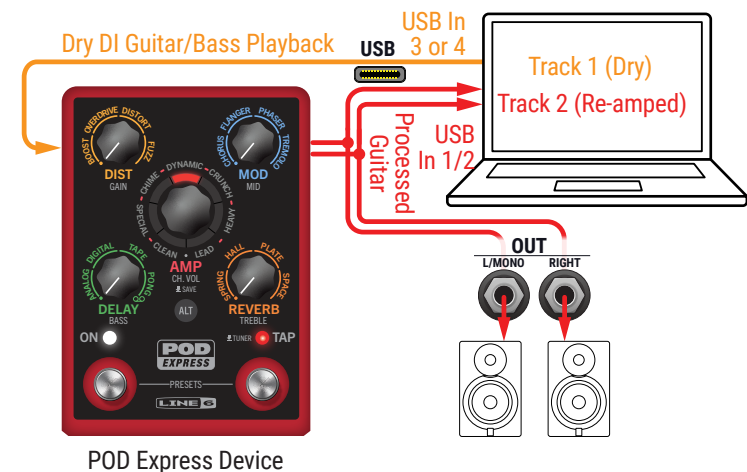

1. In your DAW software, set the DI track's output setting to **POD Express USB 3/4**.
2. Create a new stereo track in your DAW project and set both its input and output to **USB 1/2**. Arm the track for recording.

NOTE: In some DAW software it may be necessary to also activate the software monitoring feature on this "re-amped" track to monitor the processed signal when playing back your project. See your software's documentation.

3. Now play your DAW project and you'll hear the DI track "re-amped" through POD Express. Tweak your amp & effects models as desired while listening with the playback of your project mix.
4. Once you have your re-amplified guitar tone the way you like it, solo both the DI and re-amped tracks, rewind to the start of the project and hit the DAW Record button, allowing it to capture the signal into the new re-amped track in real-time.

Allow the DI track to play to the end, stop recording, and you've created your new re-amped guitar/bass track!

TIP: Note that you still have your original Guitar/Bass DI track, and you can repeat this process to create additional re-amped tracks with different POD Express settings, add plugins, blend with your original track, and more.

Core Audio Driver Settings (macOS only)

To use POD Express as an audio interface for Mac applications, it is not necessary to install any additional driver. Your POD Express device will utilize the Mac computer's class compliant USB driver automatically simply by connecting to your USB port. POD Express will then appear as a selectable Core Audio device within the Mac Utilities > Audio MIDI Setup panel and/or directly within your DAW host and multimedia applications. Note that POD Express devices offer strictly 48kHz native sample rate operation on Core Audio host devices.

ASIO Driver Settings (Windows only)

When using POD Express as an audio interface for Windows DAW applications, it is highly recommended to configure the software to utilize the POD Express ASIO driver. This ASIO driver offers the superior, low-latency audio performance required for DAW recording. Driver selection is typically found in your DAW software's Preferences or Options dialog—see your software's documentation.

NOTE: Download and install the latest Line 6 POD Express ASIO driver for Windows from line6.com/software.

Once the POD Express ASIO driver has been selected in your DAW software, you'll also see a button in the same dialog for "ASIO Settings" (or similar, depending on your DAW software). Press this button to launch the POD Express Control Panel, which allows for the following driver settings.

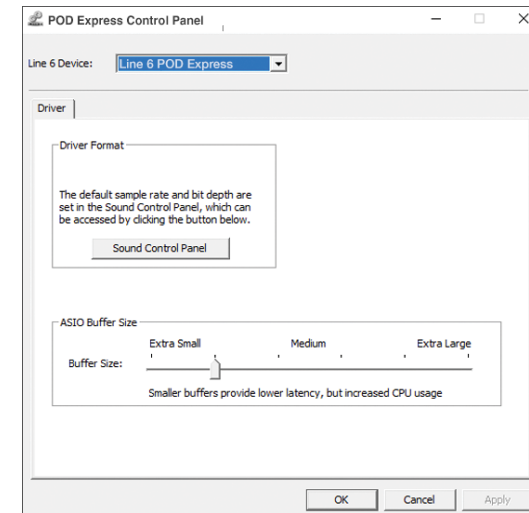

The POD Express Control Panel, USB audio settings (Windows)

Sound Control Panel - This button launches the Windows Sound Control Panel to optionally configure POD Express to be the audio playback device for multi-media applications (such as Windows Media Player, iTunes, etc.) The settings within the Windows Sound Control Panel are not relevant for your DAW software, since standard multi-media applications utilize the standard Windows driver.

ASIO Buffer Size - Your goal is to achieve the lowest latency possible in your DAW software, but with glitch-free audio performance. A smaller buffer size results in lower latency, however, also increases the demands on your computer, which can result in clicks, pops or other audio artifacts. Start with a lower slider setting and, if you encounter audio performance issues, come back to this panel and move this slider to the right incrementally to remedy the problem.

Click the Apply and OK buttons when your POD Express Control Panel settings are complete to return to your DAW software. Please also refer to your DAW software's documentation for more about its own specific audio device, buffer, and project settings.

POD Express Edit

The free **POD Express Edit** application (version 1.10 or later) can be installed on macOS & Windows computers and iOS & Android mobile devices for in-depth editing, preset management, backups, and device firmware updates.*

***NOTE:** It is required that your POD Express device is running firmware version 2.00 (or later) to be able to be used with the POD Express Edit application. The macOS or Windows app and Internet connection are required for device firmware updates. See ["Updating POD Express Firmware" on page 45.](#)



The POD Express desktop app (macOS)



The POD Express mobile app (iOS)

Software Requirements & Installation

POD Express Edit Minimum Requirements: macOS 10.14, Windows 10, iOS 12.1, or Android OS 6.0 (or newer versions).

For macOS and Windows Computers: Go to line6.com/software, download the POD Express Edit installer, then double-click the downloaded file and follow the on-screen instructions.

For iOS and iPadOS Mobile Devices: Visit the [Apple App Store](#), search for the POD Express Edit app, and follow the on-screen installation instructions.*

For Android Mobile Devices: Visit the [Google Play™ Store](#), search for the POD Express Edit app, and follow the on-screen installation instructions.*



***NOTE:** For iOS, iPadOS, and Android devices that do **not** include a USB-C connection, a USB adapter is required (sold separately):
For iOS and iPadOS devices, a USB to Lightning (Camera Kit) adapter is required.
For Android devices, a USB OTG (On-The-Go) adapter is required. Check line6.com/android for more information.

Once the POD Express Edit app is installed, power on your POD Express device via batteries or power adapter, connect via USB to your computer or mobile device, and launch POD Express Edit. The application should automatically detect your specific POD Express device and sync to display its presets and amps & effects. You will see your device name appear as an indicator that your device has been found.

If your device is not detected, or becomes disconnected, you'll see the flashing No Device indicator, as shown below.

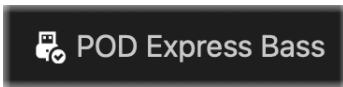

Device connected indicator
(POD Express Bass)

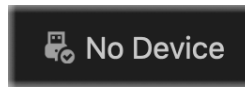

Device not connected
indicator, flashing

If **No Device** is shown, be sure POD Express is powered on and that both ends of the USB cable (and/or mobile adapter) are fully seated. It is recommended to connect directly to your computer's USB port rather than to a hub.

 Click the **Sign In** button (macOS and Windows only) at the top of the app window to sign into your Line6.com account (or create an account, if you don't already have one) to allow the app to automatically check and alert you if updates become available for your POD Express app or device firmware.

Loading and Saving Presets

When using the macOS or Windows app, you can access your POD Express device's presets by clicking on the Up/Down buttons to the right of the Preset Name field to load the next/previous preset. The loaded preset's name appears in the field. For accessing presets in the mobile app and additional preset management tasks, you can use the Preset Library—see the following section.



The Preset Field's buttons load the next/previous preset (macOS & Windows app)

TIP: You optionally can rename the current preset by clicking in the Preset Name field and typing in your new name. Save the preset to retain your new name.

Once your current preset has been edited, you'll see the preset name appear in red to indicate it is in an unsaved state. Click the **Save** button to the right of the preset field to save the current preset to your device.*



An edited preset's name appears in red

***NOTE:** For the iOS, iPadOS, and Android POD Express Edit mobile apps, use "[The Application Menu](#)" - **Save Current Preset** command.

Managing Presets in the Preset Librarian

The Preset Librarian can optionally be hidden or shown via the arrow button that appears at the top left of the app (or via the **Librarian** button within the Mobile app). The Librarian syncs to your device on app launch to display all its presets within locations 01 through 21. Click on any location to select its preset and use the Librarian command buttons to perform the desired preset management functions.*

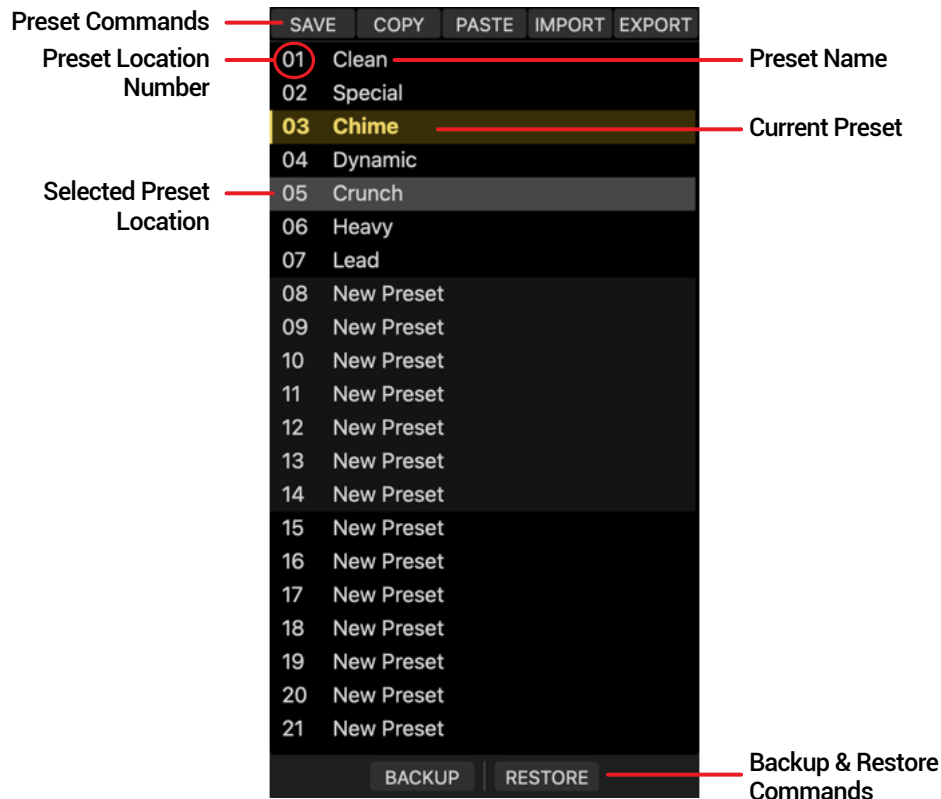

The Preset Librarian Panel (macOS)

*NOTE: In the Mobile application, tap the **Actions** button to access all preset commands.

- **Save** - Saves the current preset to your device, overwriting the preset within the current preset location.
- **Copy** - Copies the selected preset to the clipboard.
- **Paste** - Pastes the copied preset (in its last-saved state) to the selected preset location.

- **Import** - Allows you to select a preset file stored on your computer/mobile device to import it to your connected POD Express device within the selected preset location.
- **Export** - Allows you to save a copy of the selected preset to your computer/mobile device. The preset is exported in its last-saved state.
- **Backup** - Creates a complete backup of all current presets and settings to your computer/mobile device.
- **Restore** - Allows you to select a POD Express Backup file stored on your computer/mobile device and restore it to the POD Express device's internal memory, **replacing all current presets and settings**.

Reordering Presets - Within the Librarian window, you can also click directly on any preset, drag it up or down, and drop it into the desired location to reorder your device's presets.*

*NOTE: In the mobile app, tap the **Reorder** button to allow the Librarian's presets to be dragged up/down—then tap **Done** when reordering is complete.

Editing Amp & Effects Parameters

The POD Express app layout is intuitive—simply adjust the controls as desired to edit your current preset. You can audition your changes in real-time while playing through your connected POD Express. You'll see that numerous parameters are available within the app for detailed editing of any Amp, Cab, or Effect model, as well as tempo sync/note subdivision options for Delay and Modulation effects.

Selecting an Amp, Cab, or Effect Model

The Amp, Cab and four Effects each have their own Model Menu. Click to expand the menu to select the desired model.

TIP: Note that you can select **None** from the Model Menu for any Amp, Cab, or Effect to effectively bypass the category. For the Gate, turn the Threshold to minimum to disable the Gate.

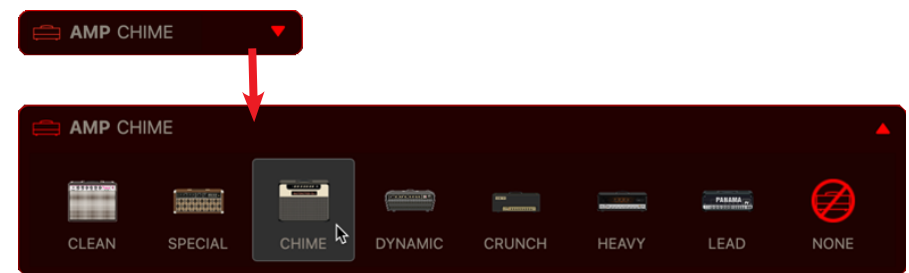

Selecting an Amp model

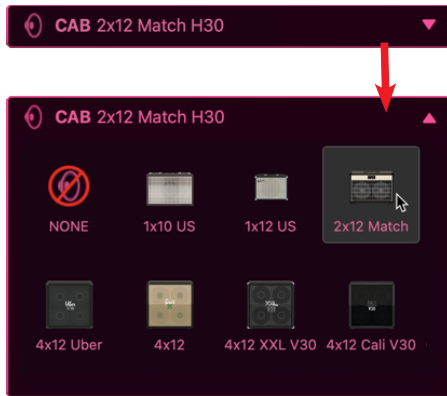

Selecting a Cab model

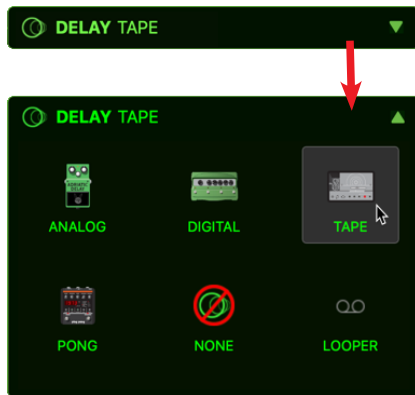

Selecting an Effect model

Accessing the Looper

Note that you can also set your device into Looper mode from within the app by selecting the Looper model from the Delay (POD Express Guitar), ModDelay (POD Express Bass), or DelayVerb (POD Express Black) category. As a bonus, the app also presents Looper level and EQ parameters, which are not available via the device itself. Loop transport controls are available via the POD Express device's ON footswitch—see [“Using the Looper” on page 27](#).

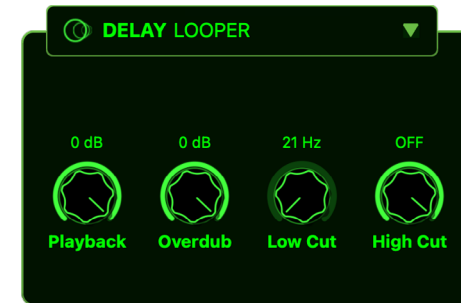

The Looper parameters

Editing Parameters

Once you've selected an Amp, Cab, or Effect model, you can easily tweak its parameters within the panel by just using your mouse to adjust the knobs, or toggle the switches. Once you've dialed in all the current Amp, Cab, and Effects, you should **Save** as a preset to retain your custom settings, as covered on [page 40](#).



Editing an Amp knob parameter

Note that some Amp and Effect models can offer more than one “page” of parameters, depending on how you've sized the app window. When you see the page indicators appear at the bottom of an Amp or Effects panel, click (or swipe) to navigate between the pages.



macOS app



iOS app

Parameter page indicators (Delay)

Editing TAP Tempo, Sync, and Note Subdivisions

For all POD Express devices, Delay models always default so that their repeats are in sync with the TAP Tempo and are heard in quarter-note subdivisions of the tempo (that is, the same rate at which you see the red TAP footswitch LED flashing). Similarly, Modulation models within POD Express Guitar and POD Express Bass devices have their modulation speed in sync with the tap tempo by default. POD Express Black's Modulation models are *not* synced to TAP tempo as their default, and you'll hear that their speed will change as you turn the MOD knob. For all devices' Delay and Modulation type models, you can use POD Express Edit to enable or disable Tempo Sync, as well as select Sync Subdivisions.

To set a tap tempo for your Sync-enabled effects - Click rhythmically on the app toolbar's TAP button (this is the same as using your POD Express device's TAP footswitch). Or, double-click on the value within the BPM control to the left to type in a precise BPM number.

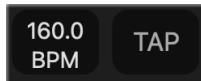

The BPM and TAP Tempo toolbar controls

To edit the Tempo Sync and Note Subdivisions - Use the controls within the app's edit panels where these models are located.

- **When Sync is enabled** (button appears lit) - The **Note** knob allows you to select a note subdivision value, from Whole at minimum to 1/64 Triplet at maximum.

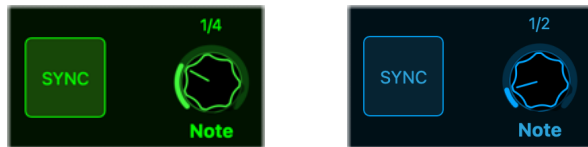

The Delay and Mod effects with Sync enabled (POD Express Guitar)

- **When Sync is disabled** (button appears dim)- The **Time** knob (Delay model) or **Rate** knob (Modulation model) below the button allows you to set a discreet value.

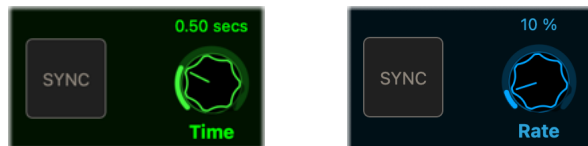

The Delay and Mod effects with Sync disabled (POD Express Guitar)

Note that when you change to a different Delay or Modulation model, the Sync state will automatically revert to the default setting. If you wish to store the Sync and note subdivision settings for the current Delay and Modulation models, **Save** to a preset.

The Application Menu



Click the guitars icon to open the Application Menu to access application settings, version info, and Help.

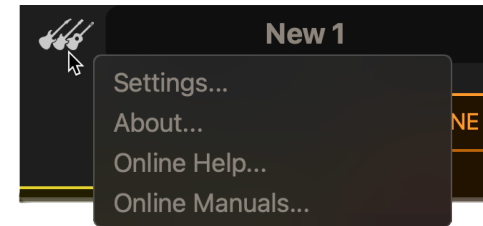

The Application Settings menu



NOTE: The iOS and Android apps include a **Save Current Preset** command within this menu, which saves the current preset to your POD Express device. In the macOS and Windows apps, the **Save** toolbar button performs this action—see [“Loading and Saving Presets” on page 40](#).

Settings - Opens the Application Settings window.

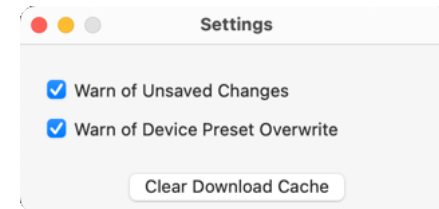

The Application Settings window

- **Warn of Unsaved Changes** - Uncheck this box if you prefer not to see a pop-up window alerting you when about the change away from an unsaved preset, or when about to overwrite a preset. (Note that you can also uncheck this setting within the prompt window as well.)
- **Warn of Device Preset Overwrite** -Uncheck this box if you prefer not to see a pop-up window alerting you when about to overwrite a preset.



TIP: Note that you can also uncheck the above settings within the pop-up windows.

- **Clear Download Cache** -Click this button to clear any downloaded firmware within the built-in Updater window. You may find this action necessary if the Updater window's **Download Update** button is shown as **Perform Update**, to clear the downloaded firmware and return the button to Download Update functionality again—also, see [“Updating POD Express Firmware” on page 45](#).

About - Opens the About POD Express Edit window, showing the installed app's version information and legal notices.

Online Help and **Online Manuals** - Take you to the Line 6 website where you can find support information and the current **Owner's Manual** for POD Express.

Accessing the Built-in Firmware Updater

(Available on the macOS and Windows apps only.) Click the toolbar's “cloud” icon button  to launch the built-in Updater utility to check for and update your connected POD Express Device's firmware. Please refer to the next chapter on [page 45](#) for details.

Configuring the Device's Global Settings

Click on the toolbar's “gear” icon button to open the Settings window to configure your POD Express device's Preset Selection behavior, Footswitch assignments, USB Audio level, and more. Please see the [“Global Settings Table” on page 30](#) for full details.

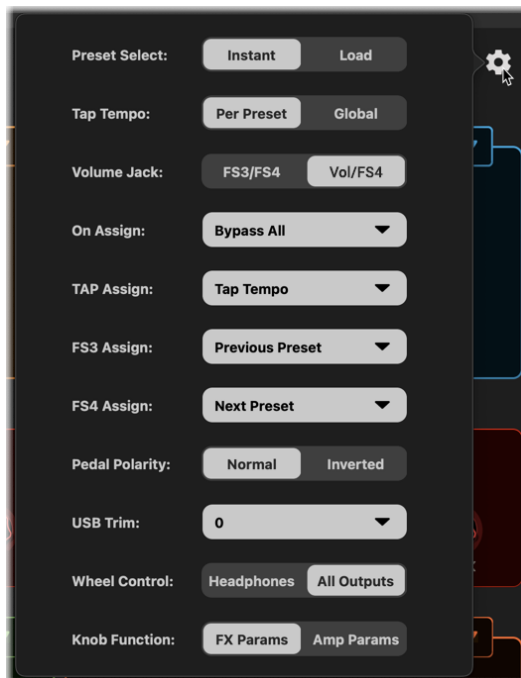



The Settings window

Updating POD Express Firmware

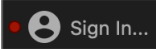

Updating your POD Express device will ensure you always have the latest models, features, enhancements, and bug fixes. To update your device, use the built-in Updater within the POD Express Edit application on your macOS or Windows computer.

NOTE: Alternatively, you can use the free **Line 6 Central** application for macOS and Windows computers to perform firmware updates on POD Express (and other current Line 6 devices), available from line6.com/software. The following update steps are very similar when using the Line 6 Central application.

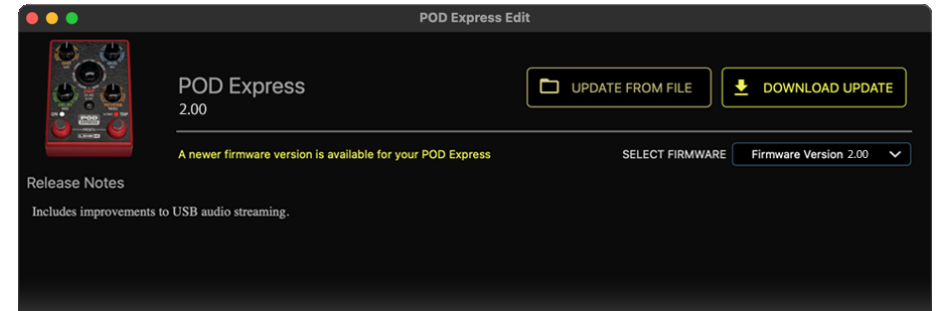
- 1. Connect the POD Express device directly to your computer's USB port (do not connect to a USB hub).**
Note that it is required you have batteries installed or a power adapter connected—your computer's USB port will not power the device.
 - 2. Launch POD Express Edit.**
On macOS - Go to Applications > Line 6 > POD Express Edit.
On Windows® - Go to the Start button menu > All Apps (or Programs) > Line 6 > POD Express Edit.
 - 3.  Click the Sign In at the top left of the app window and sign into your Line 6 account.* If you do not have an account, you must first create one. Follow the prompts through to the quick online registration.**
- *NOTE:** If the computer you are using is not connected to the Internet, it is still possible to use app to update your device offline—see ["Using the Updater in Offline Mode" on page 46](#).
- 4.  Click the Updater button to launch the built-in Firmware Updater.**
Your device's current firmware version is displayed at the top of the Updater screen. If there is a newer firmware version for your device, you'll also see this indicated, as shown in the following image.



The Built-in Updater window indicating a newer firmware is available

- 5. Select the desired firmware version from the menu to install—it is recommended to choose the latest firmware, which is typically already selected.**
- 
- The screenshot shows a close-up of the 'SELECT FIRMWARE' dropdown menu. The text 'SELECT FIRMWARE' is on the left, and 'Firmware Version 2.00' is on the right with a downward arrow.
- 6. Click the yellow Download Update button and wait for the firmware to download. Once you see the button change to a blue Perform Update label, click it to proceed.**
- 
- The screenshot shows two buttons side-by-side. The left button is yellow with a downward arrow and the text 'DOWNLOAD UPDATE'. The right button is blue with a play icon and the text 'PERFORM UPDATE'.
- 7. Allow the application to complete the update process, which can take up to several minutes. It is especially important not to disturb the device's controls and connection until the update fully completes!**
- The *License Agreement* is displayed in the next screen. Read through the agreement and click **Accept** to agree to the terms and conditions and start the update process. Read and follow any additional instructions that may appear.



Once the application lets you know the update process has completed, click the Back button to return to the POD Express Editor and start using your updated device.



NOTE: While the presets on your POD Express device will not be altered, some minor sonic changes may still occur with firmware updates, as noted within any firmware's *Release Notes*.

Using the Updater in Offline Mode

If the computer on which you are using POD Express Edit is not connected to the Internet, you can use the app's **Update from File** option to perform an update for your POD Express firmware, as follows.

1. You'll need to first obtain the latest firmware for your POD Express device by downloading it from the line6.com/software/ web page, then manually copy the downloaded file to your computer where you'll be running POD Express Edit. Connect your POD Express device directly to the computer's USB port.
2. Launch POD Express Edit and click the Updater button  to launch the Updater. Be sure to read and follow any special instructions that might appear in the app window.
3. Click the Update From File button, browse your computer, and select the POD Express firmware file you obtained in the first step.



4. The *License Agreement* is displayed in the next screen. Read through the agreement and click **Accept** to agree to the terms and conditions and start the update process. Read and follow any additional instructions that may appear.
5. Allow the application to complete the update process.



Once the application lets you know the update process has completed, click the Back button to return to the POD Express Editor and start using your updated device.

LINE 6®