



GX-100

Reference Manual

Table of contents

Getting Ready	3	Turning Off the Auto Off Function	40
Connecting the Equipment	3	Connecting to a Computer	42
Turning the Power On.....	5	Connecting with an External MIDI Device	43
Configuring the Input to Match the Instrument You		Wireless Connection with a Mobile Device	45
Connect	6	Attaching the BT-DUAL.....	45
Naming INPUT SETTINGS: 1–10.....	8	Listening to Sound via Wireless Connection with a Mobile	
Specify the Type of Amplifier You Have Connected	10	Device	46
Adjusting the Volume.....	11	Controlling the GX-100 from a Mobile Device App	48
Using the Tuner	12	Footswitch and Expression Pedal Settings	49
Playing	14	Assigning a Function.....	49
Selecting a Memory	14	ASSIGN SETTING.....	49
About the Play Screen	16	TARGET list.....	53
Assigning Favorite Parameters to [1]–[4] Knobs	18	Virtual Expression Pedal System (Internal Pedal / Wave	
Selecting the Control Mode	19	Pedal).....	66
Editing: Effects	23	Adjusting the Expression Pedal (Pedal Calibration).....	67
Basic Procedure for Effect Editing	23	Connecting External Pedals	69
Effect Placement.....	26	Looper	70
Switching Tones Without Interrupting the Sound	31	Error Message List.....	72
Preserving the Tail of the Effect (Delay, Reverb, etc.) when		Main Specifications	73
the Effect is Switched Off (Carryover)	31		
Saving a Memory.....	33		
Editing: MENU	35		
Basic MENU Operations	35		
Adjusting the Contrast (Brightness) of the Display	37		
Restoring the Factory Settings (Factory Reset)	38		



Getting Ready

This chapter explains how to get ready to play with the GX-100, including connecting the devices, the instruments to use, how to make the basic settings suitable for your amp and so on.

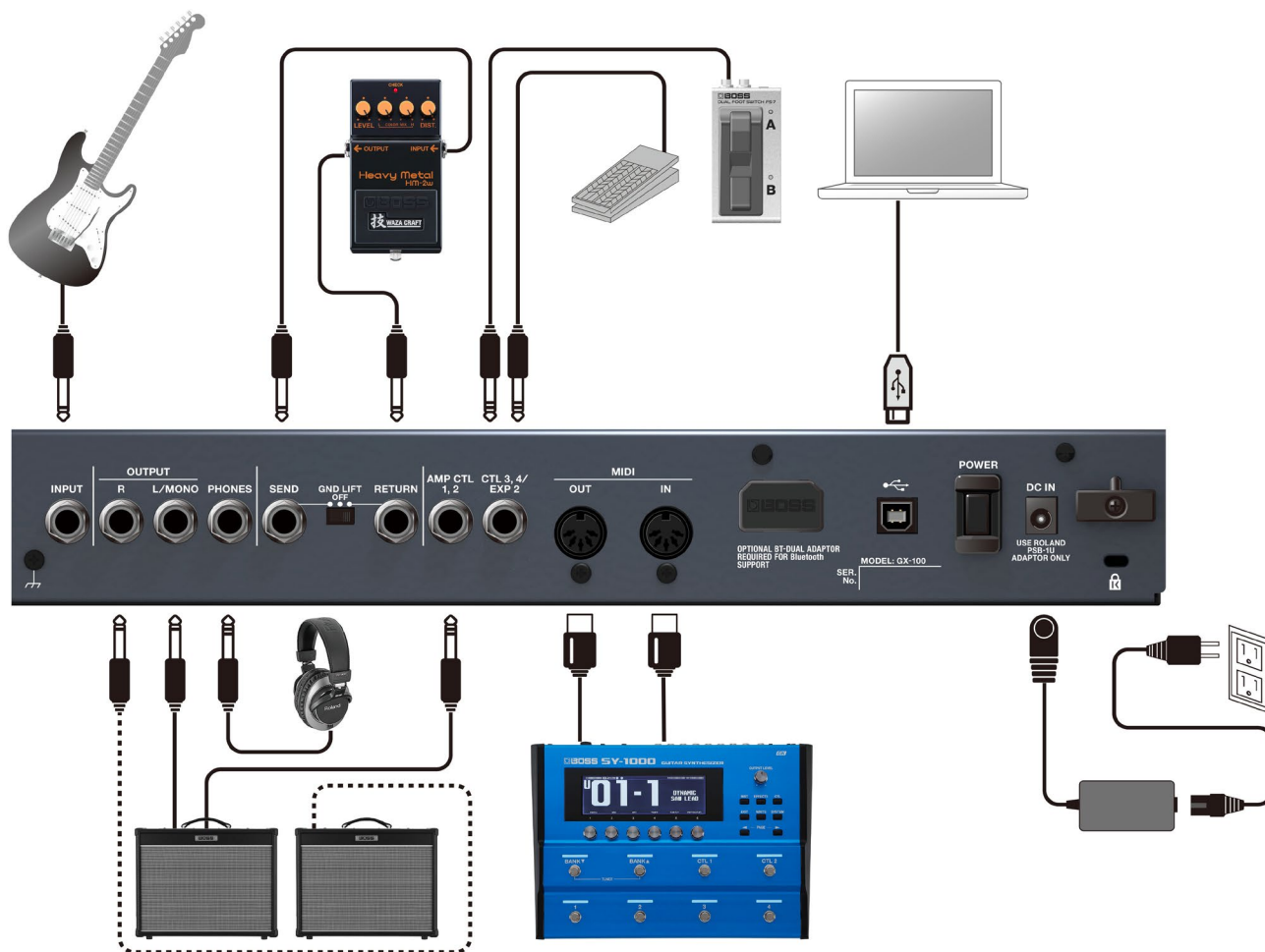
Connecting the Equipment

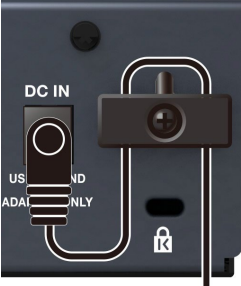

Name of jack, port or connector	Explanation
INPUT	Connect your guitar here.
OUTPUT L/MONO, R PHONES	Connect these to your guitar amp or mixer. If using a mono connection, use only the L/MONO jack. Connect your headphones here.
SEND/RETURN	Connect an external effect processor here. You can connect an external effects processor between the SEND jack and RETURN jack, and use it as one of the GX-100's effects processors. The sound that is input to SEND/RETURN within the effect chain will be output to the SEND jack. The sound that is input via the RETURN jack will be input to SEND/RETURN within the effect chain. MEMO [GND LIFT] switch This should normally be set to OFF. Noise may occur due to a ground loop when you connect an amp to the EXT LOOP (SEND/RETURN) jack. The noise may be eliminated if you switch to LIFT.
AMP CTL 1, 2	By connecting this to the channel switching jack of your guitar amp, you can switch channels from the GX-100.
CTL3, 4/EXP2	You can control various parameters by connecting an expression pedal (Roland EV-5: sold separately) or a footswitch (FS-5U, FS-6, FS-7: sold separately). * Use only the specified expression pedal. Connecting expression pedals made by third-party manufacturers may cause this unit to malfunction.

Name of jack, port or connector	Explanation
	<p>* Refer to 8.3. Connecting External Pedals(P.69) for the footswitch (FS-5U, FS-6 or FS-7, sold separately) settings.</p>
MIDI IN/OUT	Connect an external MIDI device here.
 (USB COMPUTER)	Use a USB cable to connect to a computer and exchange audio/MIDI data between the GX-100 and the computer.
DC IN	<p>Connect the included AC adaptor here.</p> <p>* Use the cord hook to secure the cord of the AC adaptor as shown in the illustration.</p> 
Ground terminal 	Connect this to an external earth or ground. This should be connected when necessary.

Turning the Power On

Turn the power on by following the steps below.

1. Turn down the volume of the connected device.
2. Connect your equipment to the OUTPUT jack(s).
3. Connect the guitar to the INPUT jack.
4. Turn on the power of the GX-100.
5. Turn on the power of the amp(s).

To turn the power off, reverse the order.

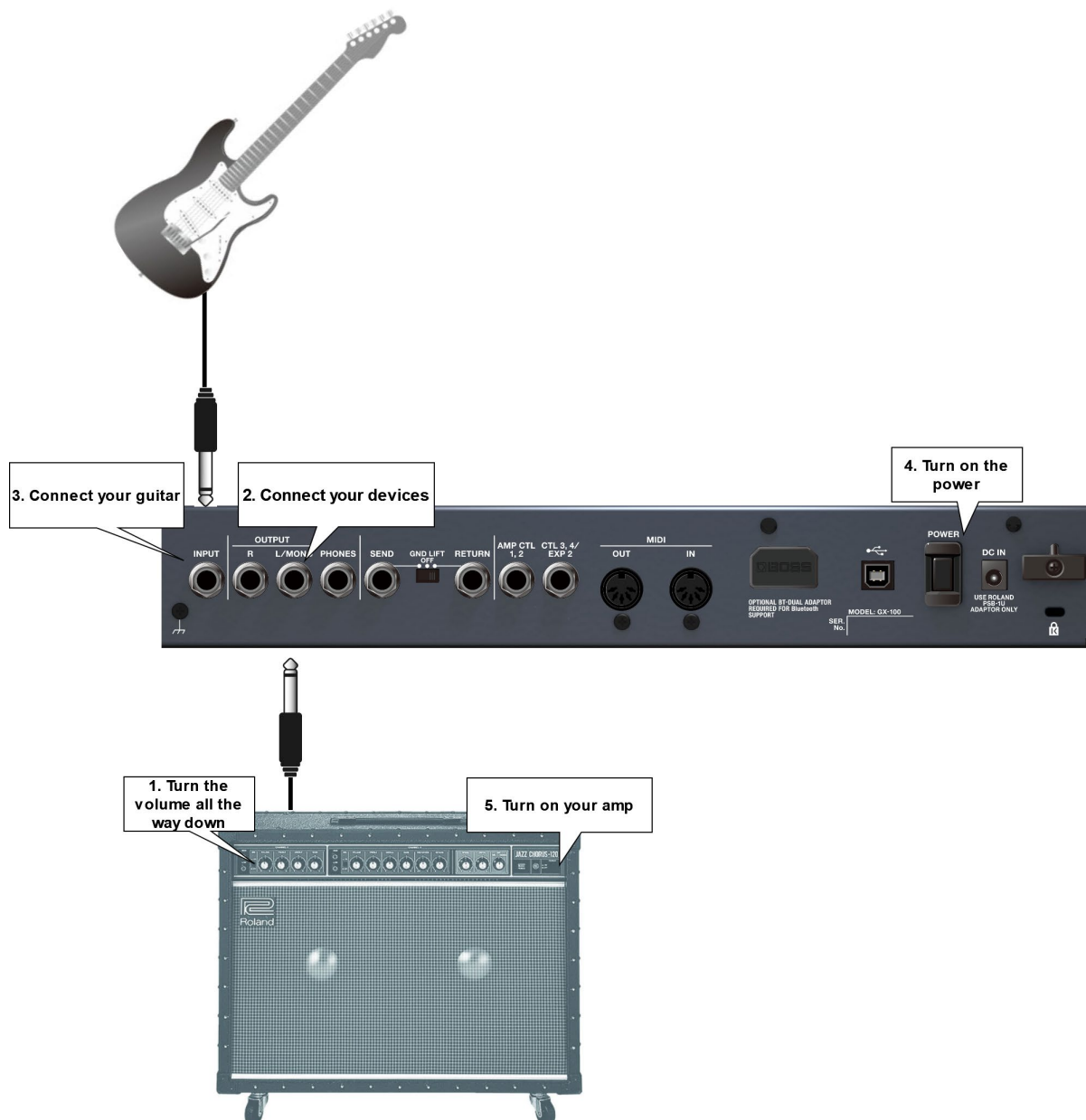

NOTE

Touch operations do not work correctly if your fingers or other objects are touching the screen while you turn on the power. Don't touch the screen with your fingers or any other objects while you turn on the power.

Configuring the Input to Match the Instrument You Connect

This shows you how to set the type of instrument to connect (guitar/bass), and how to adjust the input level to match the output level of your instrument.

You can save up to 10 instrument type and input level settings.

1. Press the [IN/OUT SETTINGS] button.

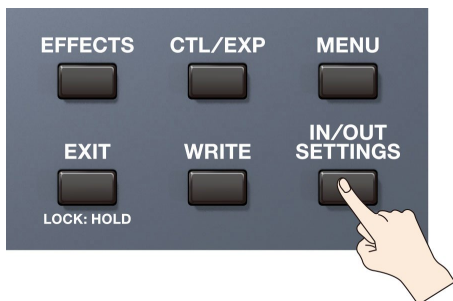

2. Touch <INPUT SETTINGS> on the screen (or press the [1] knob).

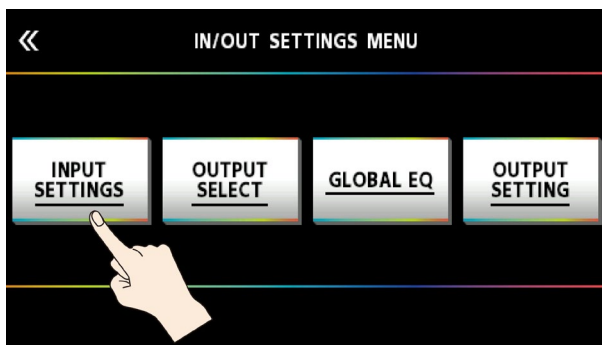

3. Turn the [3] knob to select "GUITAR" or "BASS."

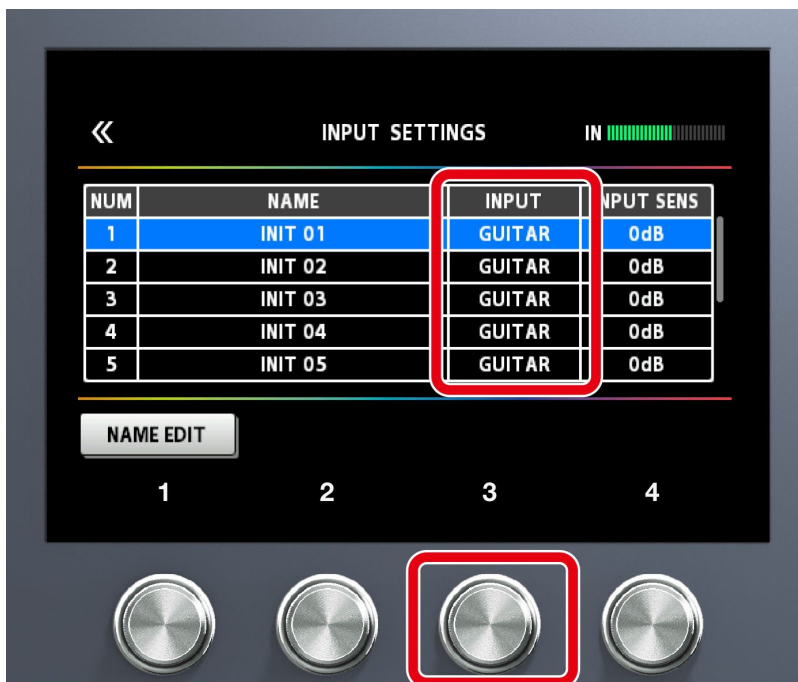

4. Turn the [4] knob while watching the level meter at the top right-hand part of the screen to adjust the input level.

Adjust the input levels so that the yellow peak indicator lights momentarily when a guitar is strummed strongly.

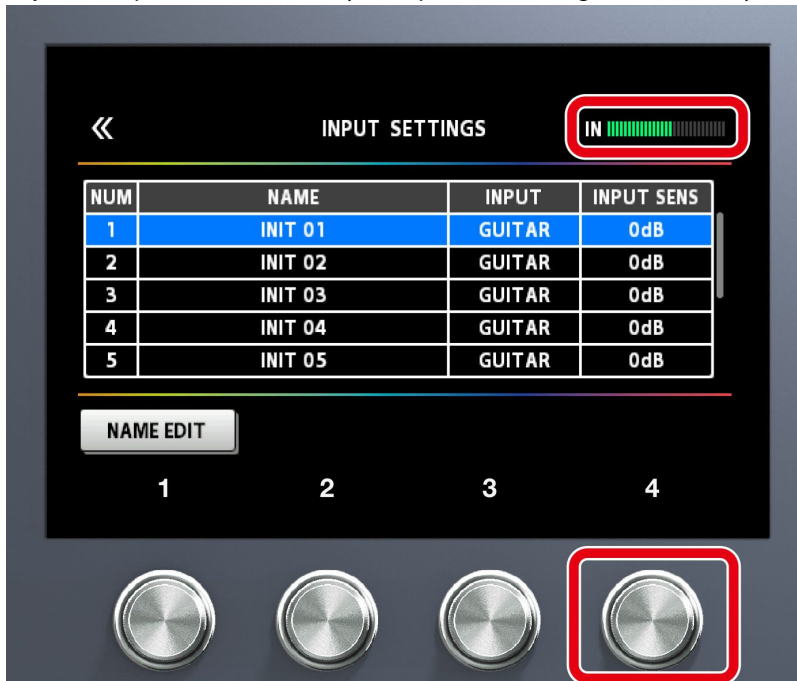

5. To configure INPUT SETTINGS: 2–10, use the [1] knob to select the setting, and repeat steps 3–4.

The blue-colored setting that's selected using the [SELECT] knob is the setting that's currently used (SYSTEM).

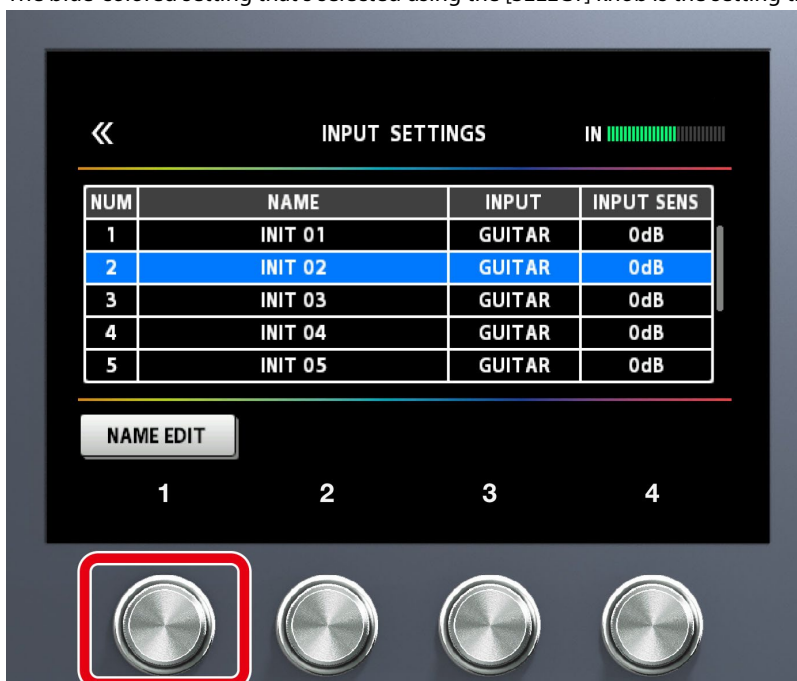

MEMO

- You can select INPUT SETTINGS for each memory. Select 1–10 or SYSTEM in the INPUT SETTING of MASTER for the last component in the effect chain.

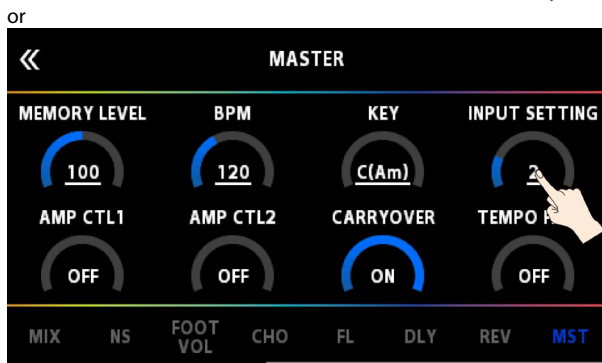
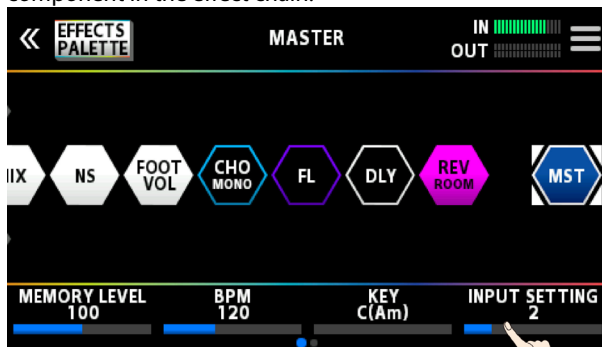

- You can name and save INPUT SETTINGS: 1–10. For details on the settings, refer to “Naming INPUT SETTINGS: 1–10(P.8) .”

Naming INPUT SETTINGS: 1–10

1. Touch <NAME EDIT> on the screen.

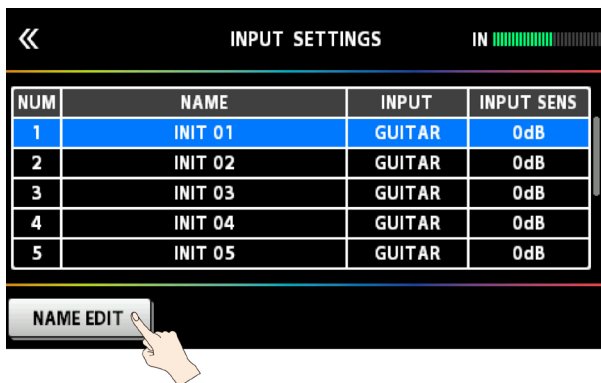

2. Use the PAGE [◀] [▶] buttons to move the cursor and use the [SELECT] knob to change the character.



Operation	Function
Turn the [2] knob	Selects the type of characters
Turn the [3] knob	Switch uppercase/lowercase
Press the [3] knob	Delete one character (delete)
Turn the [SELECT] knob	Changes the character
Press the [4] knob	Insert one space (insert)
Press the [◀] [▶] buttons	Moves the cursor
Touch <DELETE ALL>	Delete all characters

3. Touch <EXEC: [WRITE]> on the screen.

MEMO

You can also write the name by pressing the [WRITE] button.

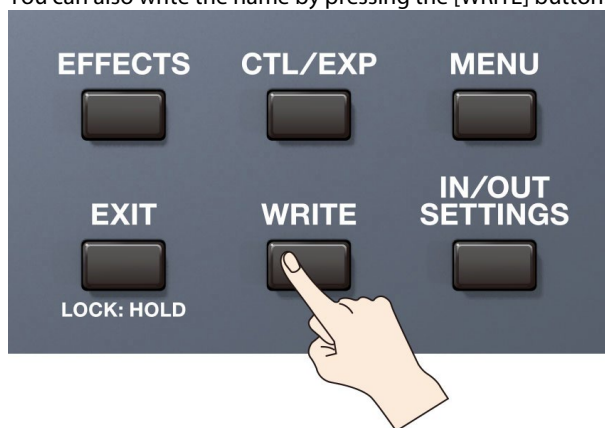

Specify the Type of Amplifier You Have Connected

1. Press the [IN/OUT SETTINGS] button.

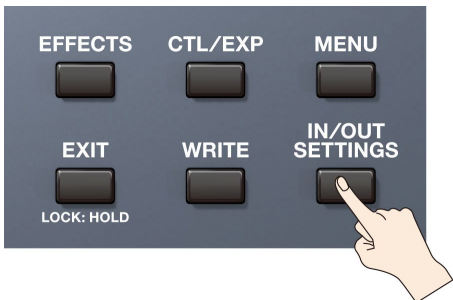

2. Touch <OUTPUT SELECT> on the screen (or press the [2] knob).

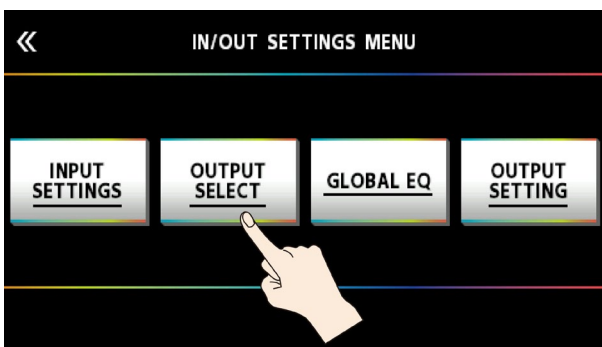

3. Turn the [4] knob or [SELECT] knob to select the item that you want to set.



* For details on the amp types, refer to the "GX-100 Parameter Guide."

MEMO

In order to take full advantage of the GX-100's capabilities, we recommend that you connect to an input that is not affected by a preamp; for example, you should connect to a RETURN jack rather than to a guitar input jack which is affected by the preamp of your guitar amp.

Adjusting the Volume

Use [OUTPUT LEVEL] knob to adjust the overall volume of the GX-100.

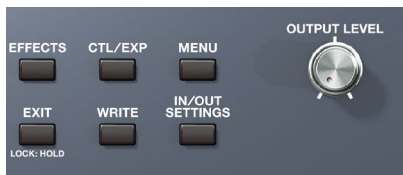

The output level is shown in the top right-hand part of the screen.

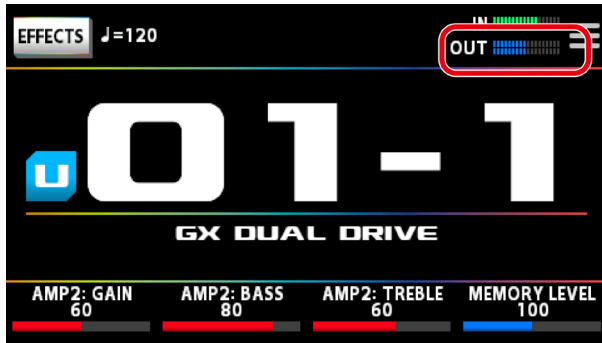

Using the Tuner

The GX-100 is equipped with a conventional monophonic tuner which lets you tune your instrument one string at a time, and a polyphonic tuner which lets you play and tune all of your open strings simultaneously.

1. Press the [C2/TUNER] switch.



The tuner screen appears.

MEMO

You can also start the tuner from the [play screen](#)(P.16) by pressing the PAGE [◀] buttons.

Switching the tuner display

You can turn the [SELECT] knob to switch the tuner display.

Monophonic (normal)/polyphonic display

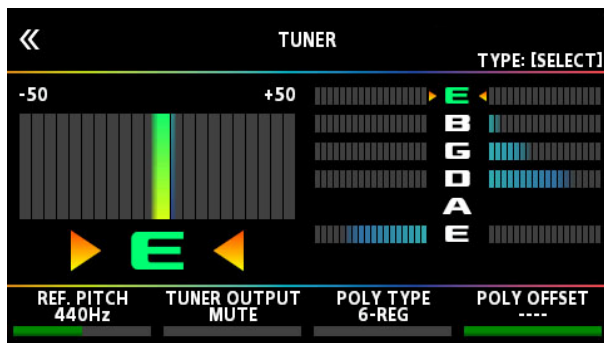

Monophonic (streaming)/polyphonic display

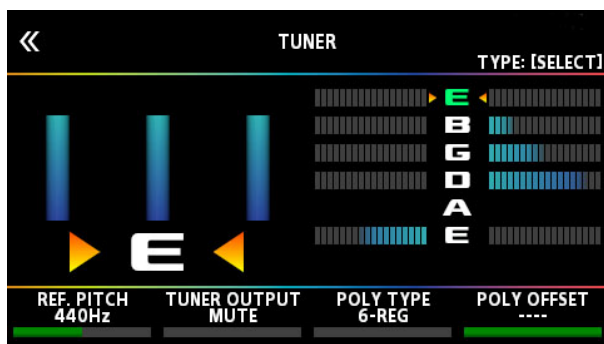

Monophonic (normal) display

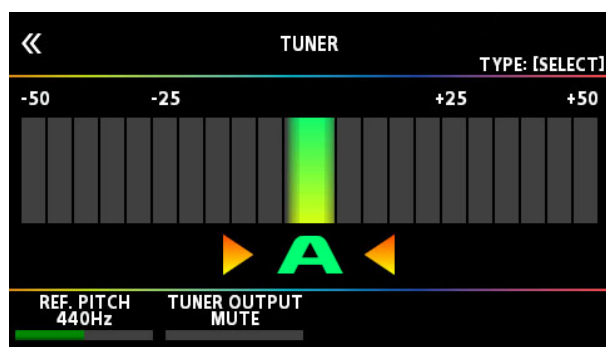

Monophonic (streaming) display

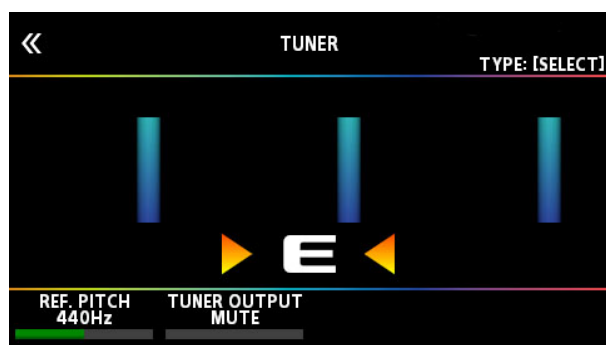

Polyphonic display

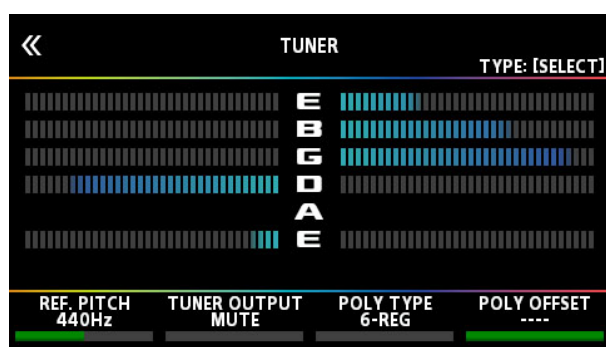

Tuner Settings

To make tuner settings, use knobs [1]–[4] located below the display.

Knob	Parameter	Value	Explanation
[1]	REF. PITCH	435–445 Hz (default: 440 Hz)	Specifies the reference pitch.
[2]	TUNER OUTPUT	MUTE	Sound will not be output while tuning.
		BYPASS	While tuning, the sound of the guitar being input to the GX-100 will be output without change. All effects will be off.
		THRU	Allows you to tune while hearing the current effect sound. * Only for monophonic tuner.
[3]	POLY TYPE	6-REG, 6-DROP D, 7-REG, 7-DROP A, 4-B REG, 5-B REG	Selects the type of tuning for the polyphonic tuner.
[4]	POLY OFFSET	-5--1, ----	Adjusts the reference pitch of the polyphonic tuner in semitone units relative to standard tuning.

Playing

This section explains the basic operations when you are playing, including how to select the preset and user memories stored in the GX-100, how to switch the individual effects on/off, the screens that are displayed and so on.

Selecting a Memory

A combination of effects and their settings is called a “memory.”

Memory type	Explanation
User memory (U01-1–U50-4)	Can be overwritten
Preset memory (P01-1–P25-4)	Cannot be overwritten. However, you can write a Preset memory into the User area, modify the settings to your needs and store your modified version in the User area.

Selecting a memory using footswitches on the top panel

1. Use the BANK [▼] and BANK [▲] switches to select a bank.
2. Use the [1]–[4] switches to select a memory within the selected bank.



Selecting a memory using the touch panel

You can swipe the memory number horizontally or vertically to switch between memories on the [play screen](#) (P.16) that appears when the power is turned on.

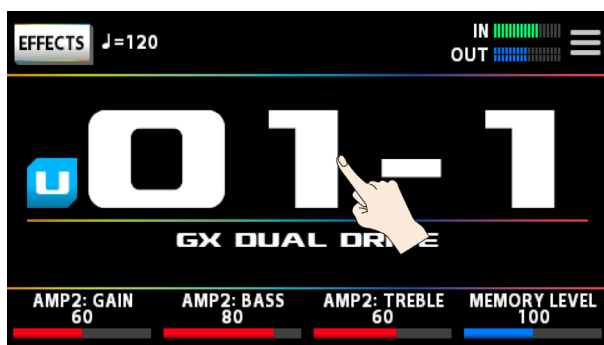



On other play screens, you can switch between memories by horizontally swiping the memory number and memory name at the top of the screen.

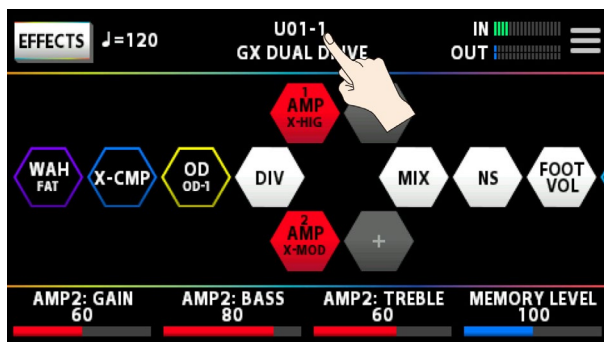
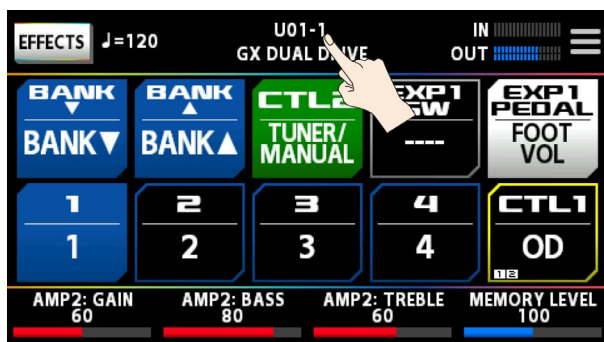

MEMO

You can also change memories by turning [SELECT] knob below the display.

About the Play Screen

The screen that appears after you turn on the power is called the “Play screen.”

You can press the PAGE [◀] [▶] buttons to switch between display modes on the play screen (tuner ↔ memory number display mode ↔ memory name display mode ↔ control mode ↔ chain mode).



Memory number display mode (the display mode used when turning on the power)

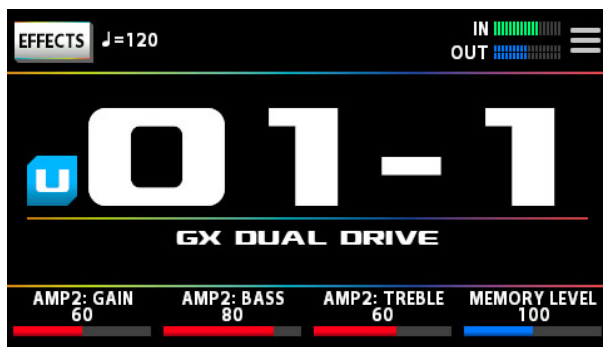

Memory name display mode

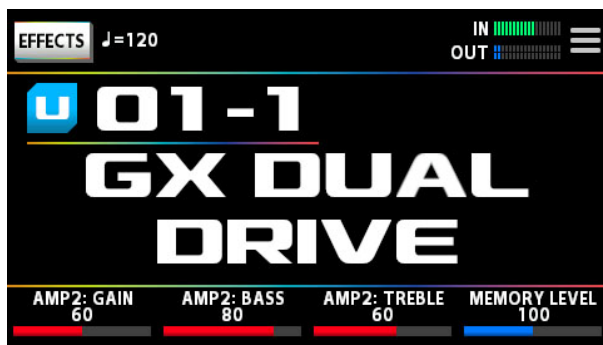

Control mode

You can touch the screen to switch between banks and memories, in the same way as when you use the footswitches on the top panel.

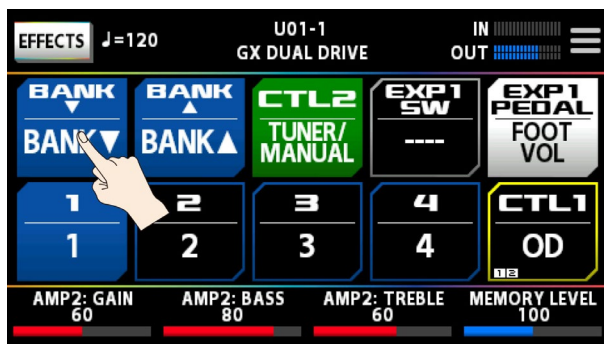

Chain mode

Shows how the effects are arranged together for the selected memory.

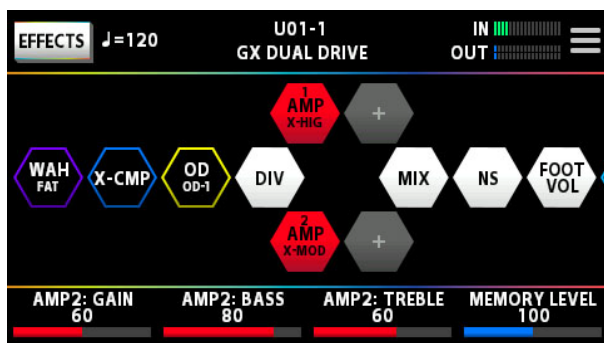

* You can't edit the effects chain using touch operations on the play screen when in chain mode. Touch the <EFFECTS> icon at upper left, or press the [EFFECT] button to enter edit mode. For details, refer to "3.1. Basic Procedure for Effect Editing(P.23)."

Tuner mode

From memory number display mode, press the [◀] button to view this mode.

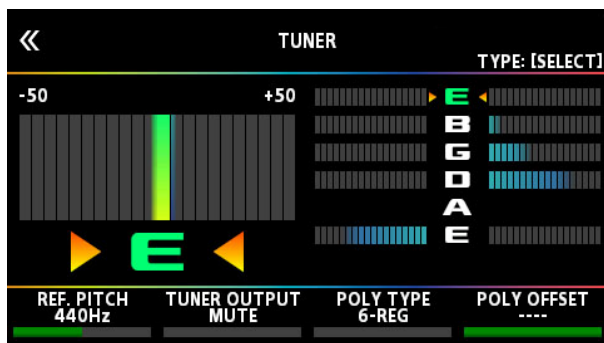

MEMO

Drag the respective parameters at the bottom of the screen to the left or right to change their values. You can also use the [1]–[4] knobs below the screen to change the values.



Assigning Favorite Parameters to [1]–[4] Knobs

Here's how to assign the parameters that are controlled by knobs [1]–[4] when the play screen is shown.

1. Press the [CTL/EXP] button.

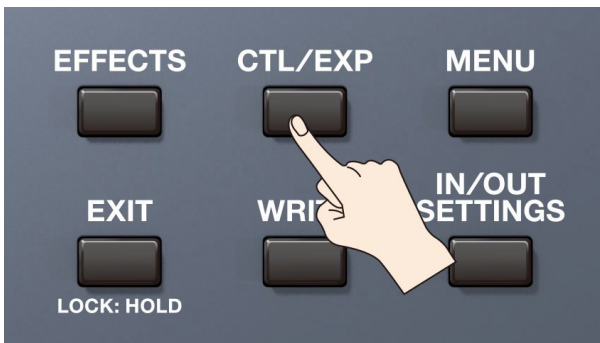

2. Touch <KNOB SETTINGS>.

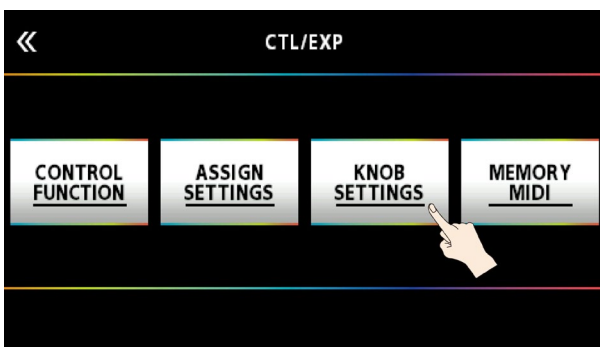

3. Turn the [SELECT] knob to select the knob you want to set. Turning the knob will move the selected item vertically.



4. Use the [2] and [3] knobs to edit the settings of the selection parameters (CATEGORY, TARGET) for each knob.

For the parameters to set, refer to "8.1.2. TARGET list(P.53)."

Selecting the Control Mode

The control mode lets you choose how you want to operate the effects.

Long-press [C2] to switch the control mode.

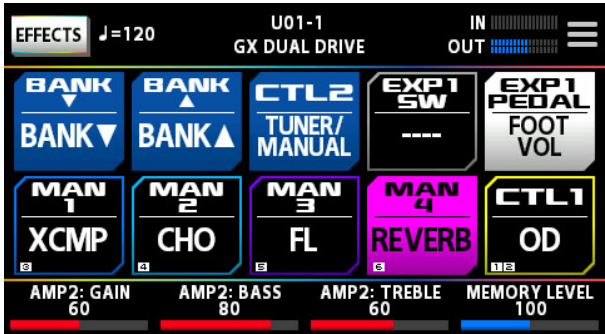

Parameter	Explanation
MEMORY (Memory mode)	<p>This mode lets you recall and use the memories that are saved in the unit. Use number switches [1]–[4] to switch memories.</p> <ul style="list-style-type: none"> * With the factory settings, long-pressing the [C2/TUNER] switch puts the unit in manual mode. * Even in memory mode, you can select functions other than memory recall.
MANUAL (Manual mode)	<p>This mode lets you use number switches [1]–[4] to operate the functions that are assigned to them by each memory or by the settings for the entire system. The play screen switches to the manual mode display of the control mode screen when the unit is set to manual mode.</p> 

MEMO

You can also follow the steps in [4.1. Basic MENU Operations](#)(P.35) to switch the control mode.

1. Press the [MENU] button.



2. Touch the <CONTROL MODE> icon on the screen.

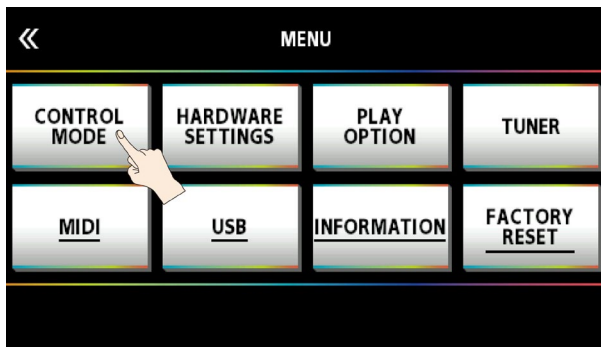

3. Touch the icons on the screen to select the control mode.

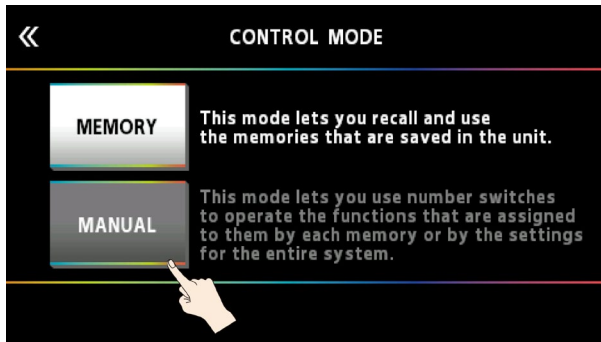

Assigning the switches in manual mode

In manual mode, the functions that are assigned to [1]–[4] switches can be changed as follows.

1. Press the [CTL/EXP] button.

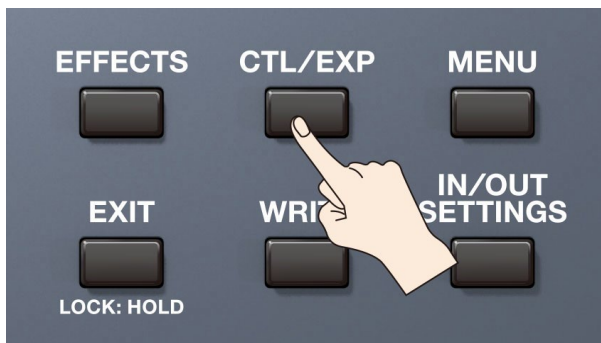

2. Touch <ASSIGN SETTINGS>.

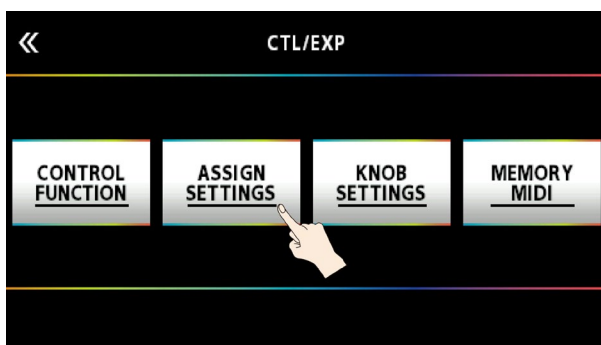

The ASSIGN SETTINGS screen appears.

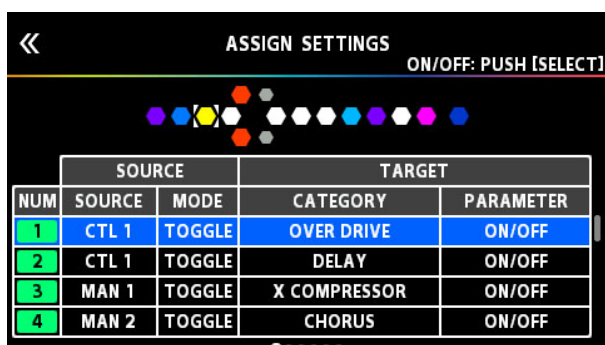

3. Turn the [SELECT] knob to select ASSIGN NUMBER (NUM).

Turning the knob will move the selected item vertically.

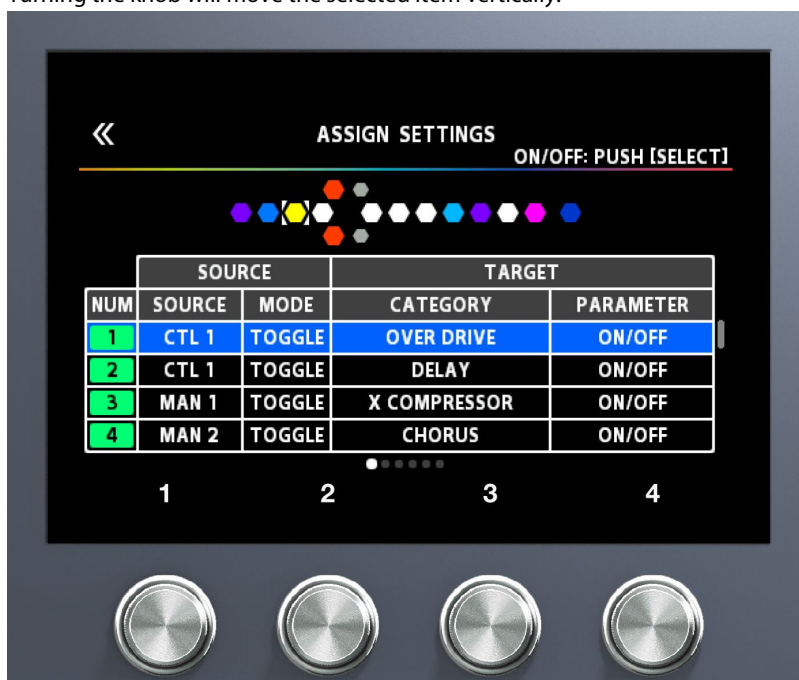

4. Use knobs [1]–[4] to select parameters or edit the values.

Knob	Setting	Explanation
[1]	SOURCE	Selects the [1]–[4] switches (MAN 1–MAN 4) for which functions are to be assigned in manual mode.
[2]	MODE	Selects the operation mode for the footswitch you selected using the [1] knob. TOGGLE: Toggles the setting on/off each time you press the footswitch. MOMENT: The setting is normally off, but turns on whenever the footswitch is operated.
[3]	CATEGORY	Selects the effect to control from a footswitch.
[4]	PARAMETER	Select the parameter for the effect you selected using the [3] knob that you want to control with the footswitch.

The ASSIGN NUMBER (NUM) that is assigned to each of the [1]–[4] switches is shown on the control mode screen.

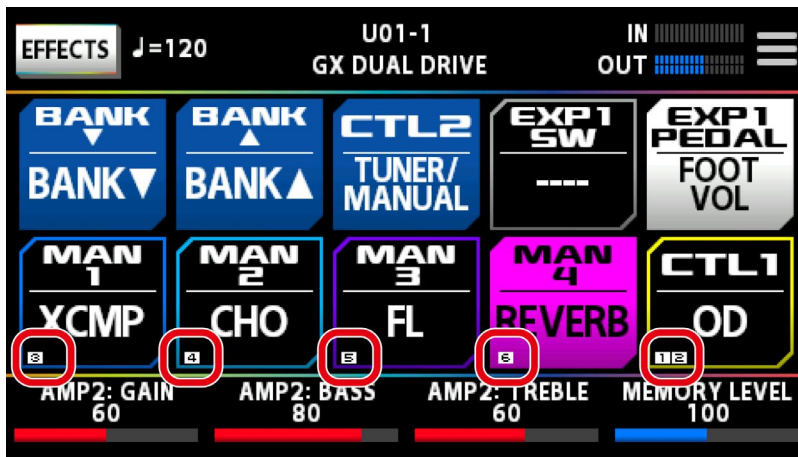

On the ASSIGN SETTINGS screen, you can assign various functions aside from the footswitch functions used in manual mode. For details, refer to “8.1.1. ASSIGN SETTING(P.49).”

Editing: Effects

This section explains how to arrange the effects, how to edit individual effects, how to store them in memory after editing and so on.

Basic Procedure for Effect Editing

Effect chain screen

The effect screen shows all of the effects used by the selected memory, as well as the output, send/return arrangement (effect chain) and so on. You can edit by selecting the icon of the effect that you want to edit from the effect chain.

1. Touch <EFFECTS> in the upper left of the screen.

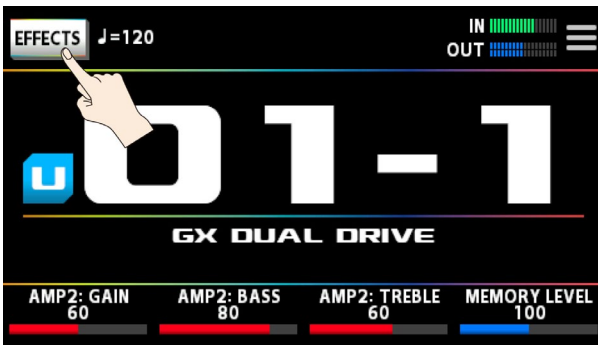

The effect chain screen is shown.

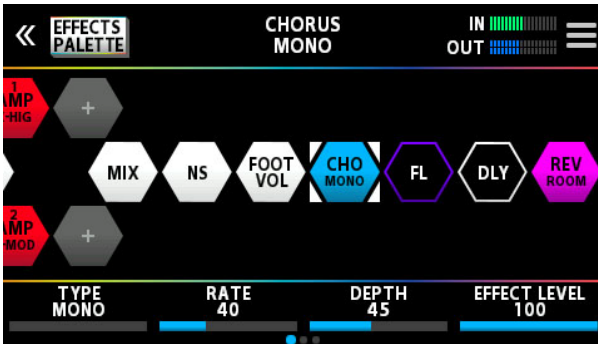

MEMO

You can also bring this up by pressing the [EFFECTS] button on the top panel.

2. Touch the icon of the effect you want to edit.

The effect toggles on/off each time you touch the icon.

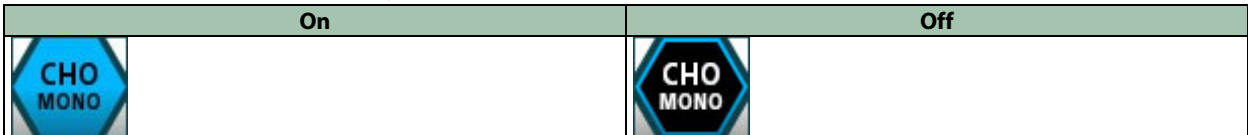

MEMO

You can also toggle the effect on/off by pressing the [SELECT] knob.

3. Drag the respective parameters at the bottom of the screen to the left or right to change their values.

Use the PAGE [◀] [▶] buttons to switch between the parameters that you want to edit. The current page is indicated in the lower center of the screen.



* The number of parameters and pages differs depending on the effect.

MEMO

You can also use knobs [1]-[4] to change the values that are shown at the bottom of the screen. To change a value in larger steps, turn a knob while pressing it.

Edit screen

Displays all parameters that you can edit for each effect.

1. Touch the icon of the effect you want to edit in the effect chain, shown in the center of the screen.
2. Touch the  mark at the top right-hand part of the screen.

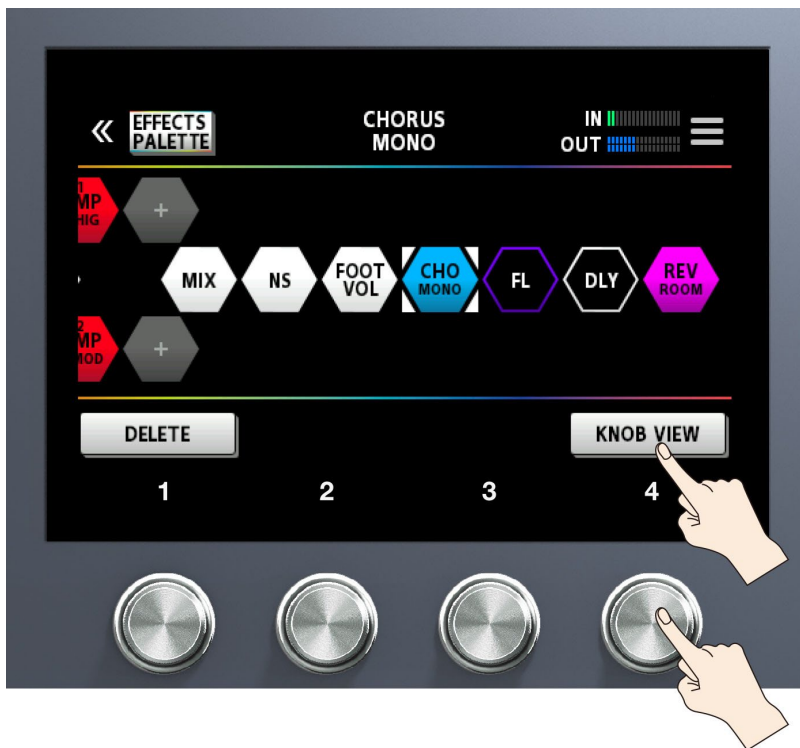

3. Touch <KNOB VIEW>. (Or press the [4] knob.)

The edit screen (KNOB VIEW) appears.

MEMO

You can display the edit screen (KNOB VIEW) by touching the icon of the effect you want to edit in step 1, and then long-pressing the [SELECT] button.

4. Drag the parameter icons up and down to change their values.

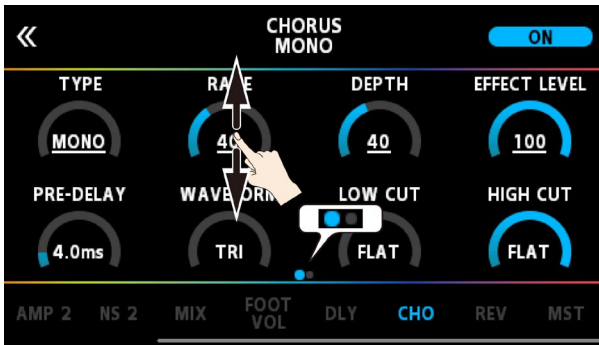

Use the PAGE [◀] [▶] buttons to switch between the parameters that you want to edit. The current page is indicated in the lower center of the screen.

MEMO

Touch an effect name at the bottom of the screen to edit that effect.

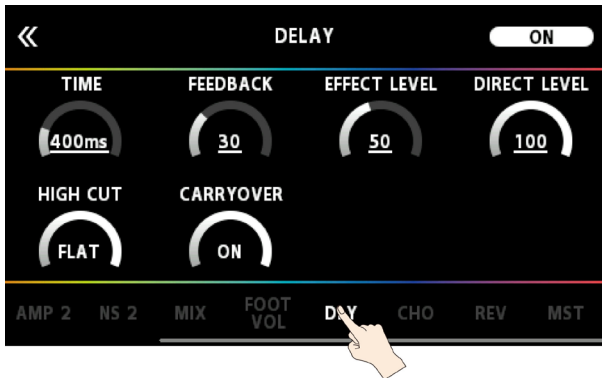

Effect Placement

By moving the icons that represent the effects, send/return and so on, you can freely change the order in which the effects are placed, or arrange them in parallel.

You can arrange up to 15 effects and functional devices such as DIVIDER/MIXER, LOOPER, SEND/RETURN and so on within the effect chain.

Maximum number of effects and functional devices that can be placed

Type	Upper limit on effects that can be placed
Same effect	9
AMP	2
LOOPER	1
DIVIDER/MIXER	1
SEND/RETURN	1

MEMO

Due to DSP capacity limits, you may not be able to insert or overwrite an effect, even when the number of connected effects falls within the limits. If there isn't enough DSP capacity, the icon for the effect you're trying to newly place in the chain is greyed out, and you cannot place the effect. To place a new effect, you must delete an existing effect.

Adding effects to the chain (insert)

1. Touch <EFFECTS PALETTE>.

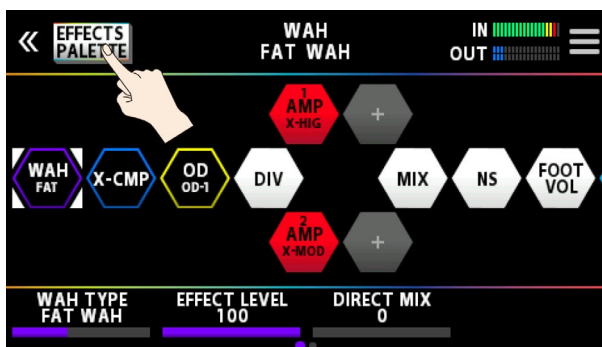

The icons representing all of the effects you can use on the GX-100 are shown in the top row (palette) of the screen. The bass guitar effects are shown after the guitar effects.

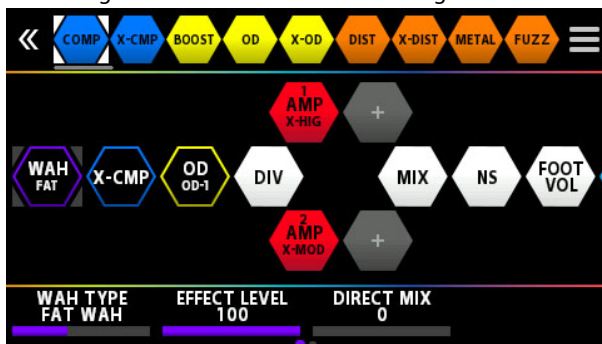

2. Drag the icon of the effects you like from the palette to the middle of the screen (the effect chain).

This example shows how to place the BOOST effect between X-COMP and OD.

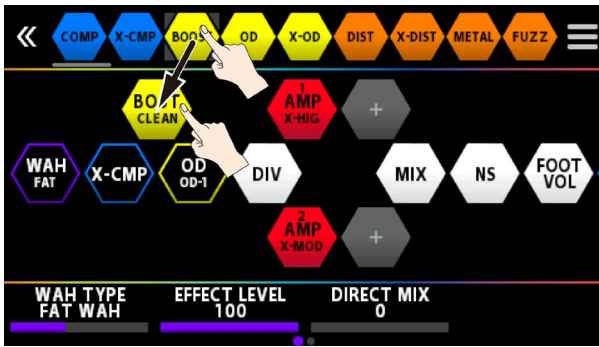

- When the “+” icon appears, release the finger you’re using to drag the icon.

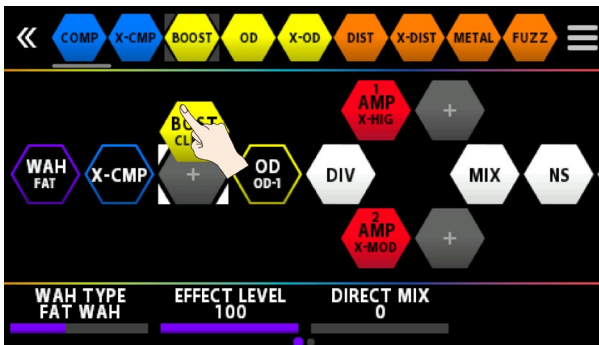

This places BOOST between X-COMP and OD.

Replacing effects in the chain with other effects (overwrite)

- Touch <EFFECTS PALETTE>.

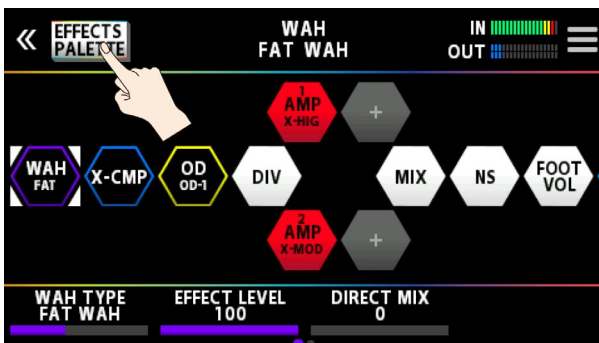

The icons representing all of the effects you can use on the GX-100 are shown in the top row of the screen.

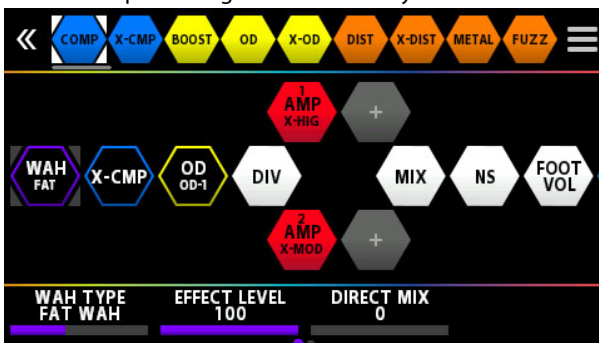

- Drag an effect icon from the top row of the screen onto the top of the effect you want to replace.

In this example, we replace OD in the chain with BOOST.

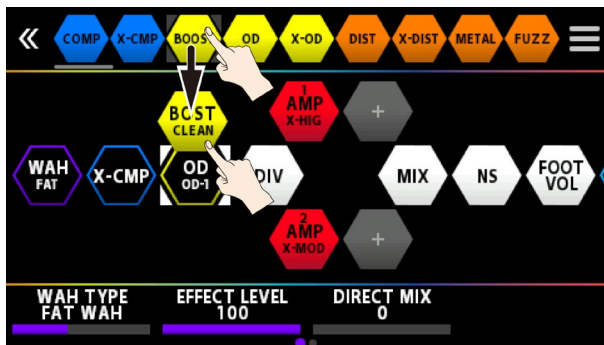

A confirmation message appears once you release your finger.

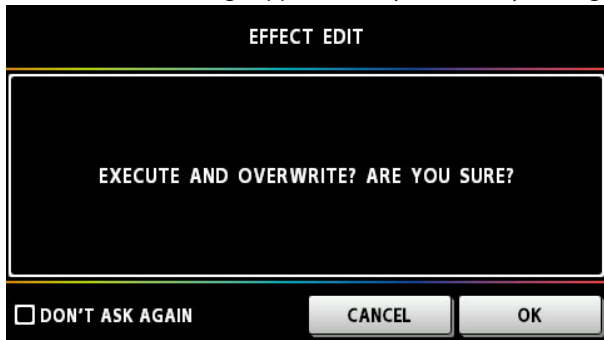

3. Touch <OK>.

The OD effect in the chain is now replaced with BOOST.

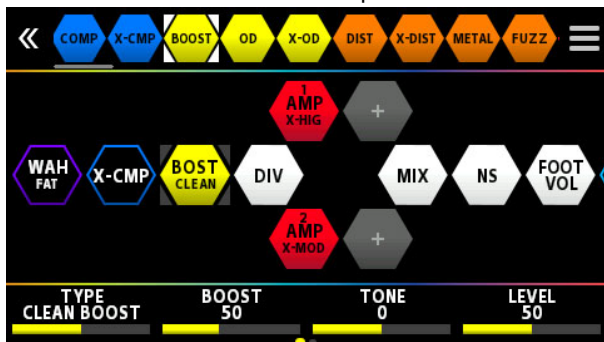

MEMO

- You can turn the [SELECT] knob to select the effect icons on the palette. You can also press the [SELECT] knob to insert an effect after the icon you've selected in the effect chain.
- Press the [SELECT] knob while holding down the [EFFECTS] button to overwrite the icon you've selected in the effect chain.
- Touch <☐DON'T SHOW AGAIN> at the lower left of the confirmation screen, select the ☐ check box and then touch <OK> if you want to delete without seeing the confirmation message from next time.

Moving effects in the chain

1. Hold down an icon and drag it from left to right to change the effect's order in the chain.

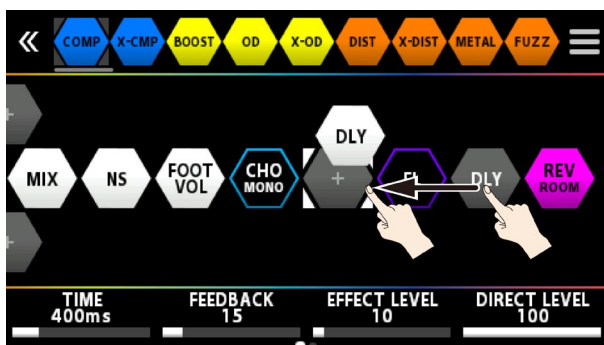

MEMO

With the effect icon selected, hold down and turn the [SELECT] knob to move the effect.

Deleting effects from the chain

1. Hold down the icon of the effect you want to delete in the effect chain at the center of the screen, and drag it to the palette at the top row on the screen.
2. Remove your finger from the icon once the background of the effect in the palette is highlighted blue.

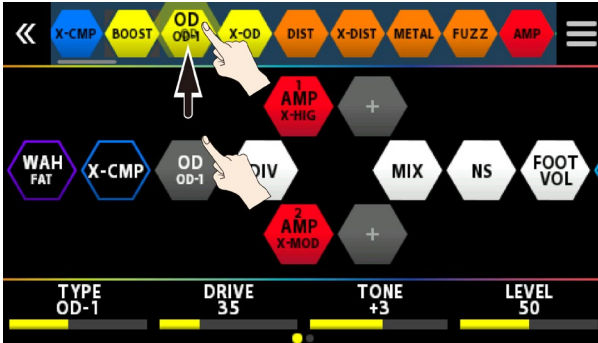

A confirmation message appears.

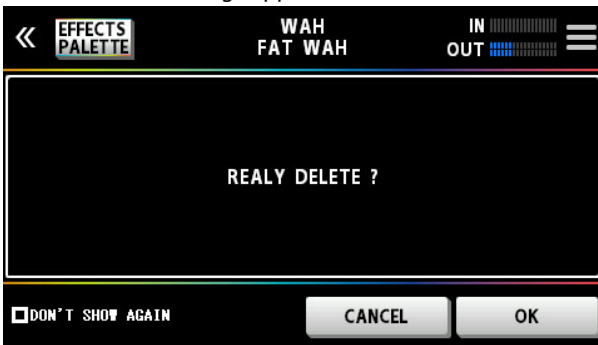

3. Touch <OK> (or press the [4] knob).

To cancel, touch <CANCEL> or press the [3] knob.

You can also use the following method to delete an effect.

1. Touch the icon of the effect you want to delete in the effect chain, shown in the center of the screen.
2. Touch the ≡ mark at the top right-hand part of the screen.



3. Touch <DELETE> (or press the [1] knob).

A confirmation message appears.

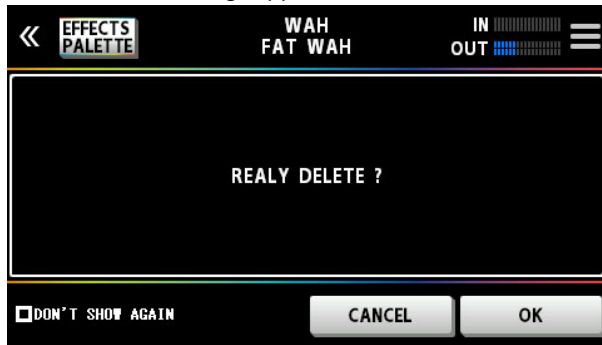

4. Touch <OK> (or press the [4] knob).

To cancel, touch <CANCEL> or press the [3] knob.

MEMO

Touch <DON'T SHOW AGAIN> at the lower left of the screen, select the check box and then touch <OK> if you want to delete without seeing the confirmation message from next time.

Rearranging effects by operating the buttons or knobs

You can use the buttons or knobs to insert, overwrite and delete effects, without using the touch panel.

Inserting

1.

Press the button to toggle between the palette and chain.

Palette is activated (the selected effect in the palette is highlighted)

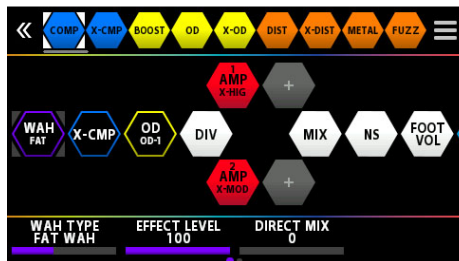

Toggle by using the [EFFECTS] button

Chain is activated (the selected effect in the chain is highlighted)

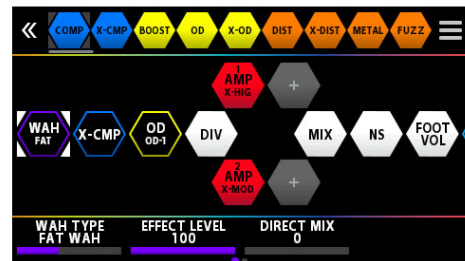

2. Use the [SELECT] knob to select the effect just before the position where you want to add the effect from the palette.
3. Press the [EFFECTS] button to activate the palette.
4. Use the [SELECT] knob to select the effect you want to place from the palette.
5. Press the [SELECT] button.

The effect that you selected in the palette is placed after the effect you selected in the chain.

Overwriting

1. Press the [EFFECTS] button to activate the palette.
2. Use the [SELECT] knob to select the effect that you want to place from the palette into the chain.
3. Press the [EFFECTS] button to activate the chain.
4. Use the [SELECT] knob to select the effect that you want to replace with the effect that you selected in the palette.
5. Press the [EFFECTS] button to activate the palette again, and press the [SELECT] knob while holding down the [EFFECTS] button.

The effect that you selected in the chain is replaced by the effect you selected in the palette.

Deleting

1. Press the [EFFECTS] button to activate the chain.
2. Use the [SELECT] knob to select the effect you want to delete.
3. Hold down the [EXIT] button and press the [SELECT] knob.

The effect you selected in the chain is now deleted.

Switching Tones Without Interrupting the Sound

Using DIVIDER and MIXER within the same memory

Place the same type of effect in parallel and use DIVIDER to switch between channels A and B.

Example:

Switching from a clean sound that uses chorus and heavy delay to a high-gain, crunchy sound that uses a phaser and light delay.

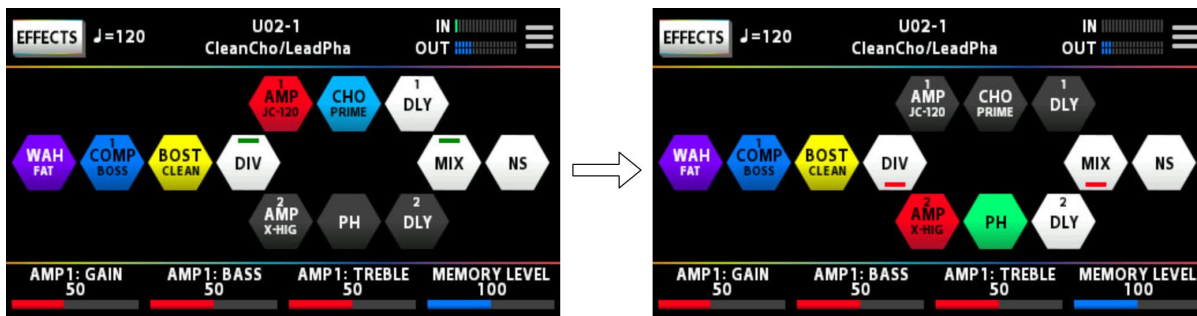

The settings of the effect used before switching are placed in parallel with the settings used after switching.

Preserving the Tail of the Effect (Delay, Reverb, etc.) when the Effect is Switched Off (Carryover)

The function that preserves the tail of an effect (such as delay or reverb) even after the effect is switched off is called “carryover.”

Enabling carryover when switching memories

To enable the carryover of the delay or reverb (included in the memory that you used before switching) after you’ve switched to a different memory, make the following settings.

- On the preceding and on the following memories, configure the effect chain to use the same effect, and use the same arrangement. Set each effect type to be the same as well.
- On each memory, change the effect parameter settings and the on/off settings.
- Turn the CARRYOVER parameter in MASTER of the final component in the effect chain to “on.”

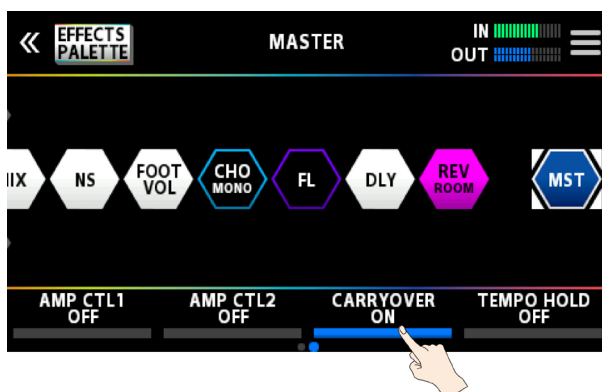

or

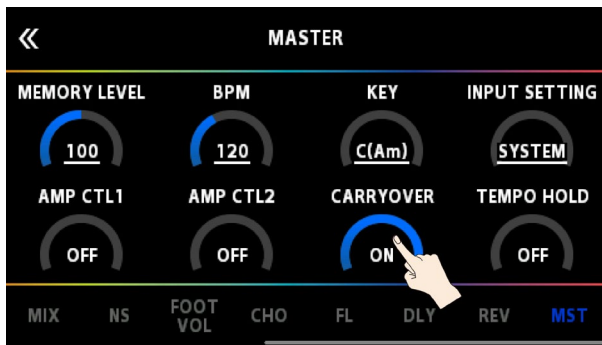

Enabling carryover when switching tones within a memory

When you use the switches within a single memory that were assigned in manual mode or by using CTRL FUNCTION to turn the delay or reverb off, carryover is enabled once you turn on the individual CARRYOVER parameters for the delay or reverb in question.

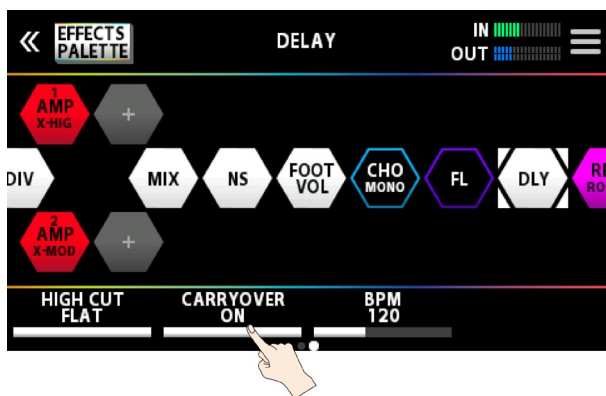

or

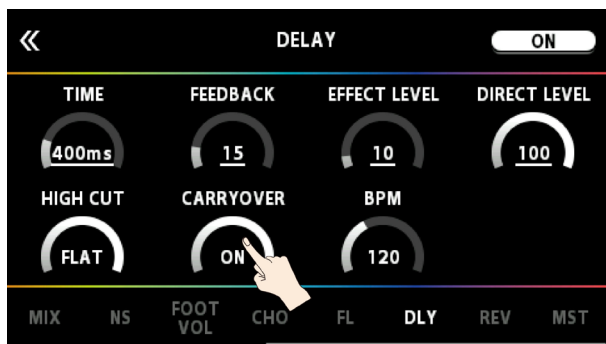

Saving a Memory

When you want to save a memory you have created, save it as a user memory by following the procedure below. If you do not save the memory, the edited settings will be lost when you turn off the power or switch to another memory.

1. Press the [WRITE] button.

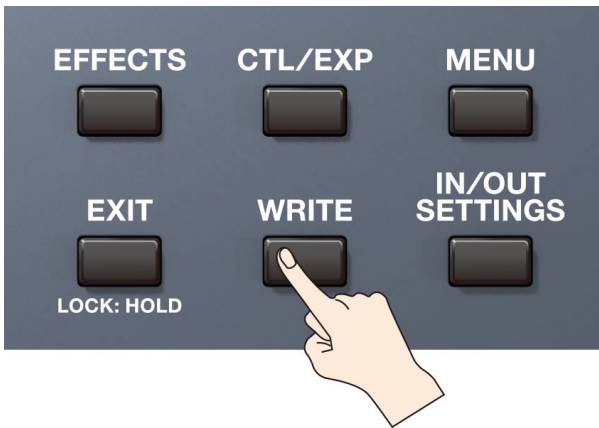

2. Touch <WRITE> (or press the [1] knob).



3. Use knob [1] to select the save-destination (U01-1-U50-4).



Hold down knob [1] and then turn it to move between banks.

You can use knobs [2]–[4] to edit the name.

To edit the memory name, use the PAGE [◀] [▶] buttons to move the cursor and use the [SELECT] knob to change the character.

Operation	Function
Turn the [2] knob	Selects the type of characters
Turn the [3] knob	Switch uppercase/lowercase
Press the [3] knob	Delete one character (delete)
Turn the [SELECT] knob	Changes the character
Press the [4] knob	Insert one space (insert)
Press the [◀] [▶] buttons	Moves the cursor
Touch <DELETE ALL>	Delete all characters

4. Touch <EXECUTE WRITE> on the screen. (Or press the [WRITE] button.)

List of WRITE MENU functions

Menu	Function
WRITE	Saves the memory you created.
EXCHANGE	On the GX-100, you can “swap” or exchange the positions of two User memories.
INITIALIZE	You can restore (initialize) each effect in a user memory to its standard settings. This is useful when you want to create a new memory from scratch.
INSERT	You can insert a memory into any position of the user memories. For example, if you insert memory U01-1 at U02-1, memory U02-1 and subsequent memories are shifted (renumbered) backward by one. (Memory U02-1 becomes U02-2.)

Editing: MENU

This section explains how to make settings that are common to the entire GX-100 (system parameters).

Basic MENU Operations

For details on the parameter (SYSTEM parameter), refer to the "GX-100 Parameter Guide."

1. Press the [MENU] button.



2. Touch the icon of the parameter you want to set.

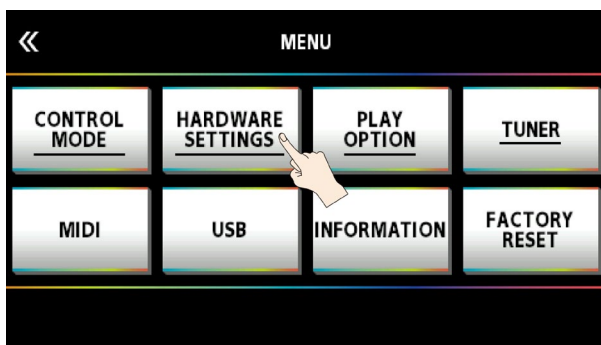

A sub-menu may appear depending on the parameter, which you can also touch to set.

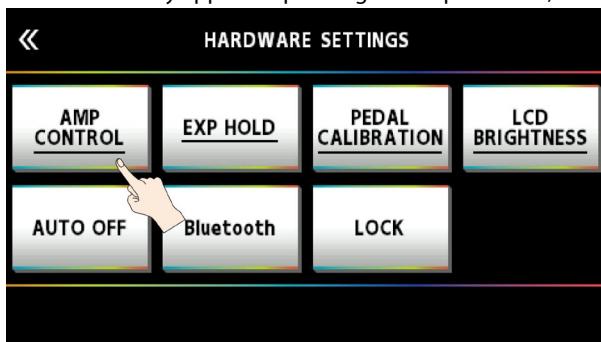

3. Drag the parameter icons up and down to change their values.

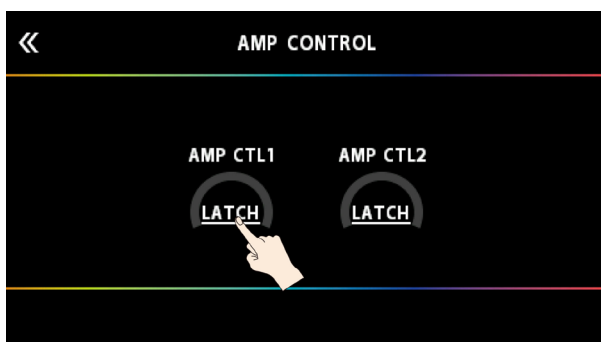

MEMO

You can also use the [1]–[4] knobs below the parameter icons to change the values.

Selecting menus with the buttons or knobs

You can use the buttons or knobs to select menus or sub-menus instead of using the touch panel.

1. **Turn the [SELECT] knob to select either the top row or the bottom row of the menu.**

The menu items on the selected row are underlined.

上段

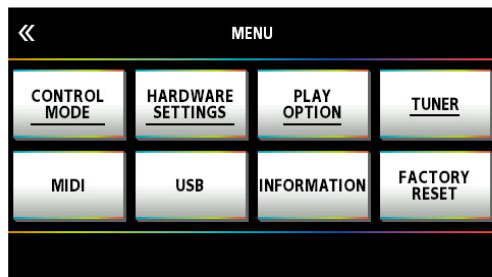

[SELECT] つまみで切り替え

下段

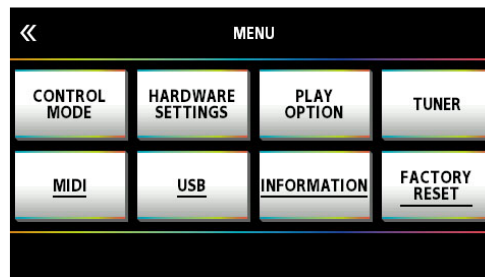

2. **Press the [1]–[4] knobs to select the menu.**

Adjusting the Contrast (Brightness) of the Display

You can adjust the brightness of the display.

1. Press the [MENU] button.



2. Touch <HARDWARE SETTINGS>.

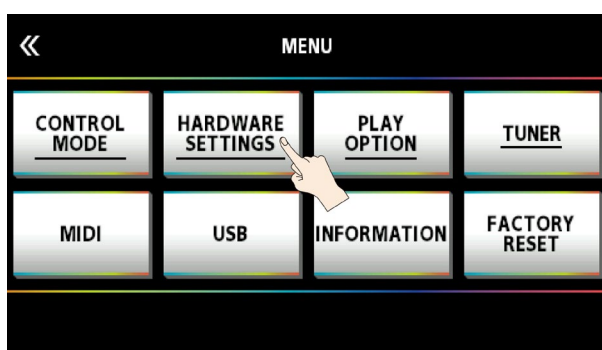

3. Touch <LCD BRIGHTNESS>.

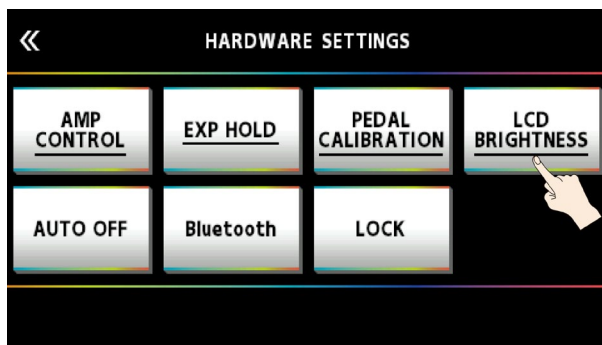

4. Drag the <LCD BRIGHTNESS> up and down to adjust the brightness.

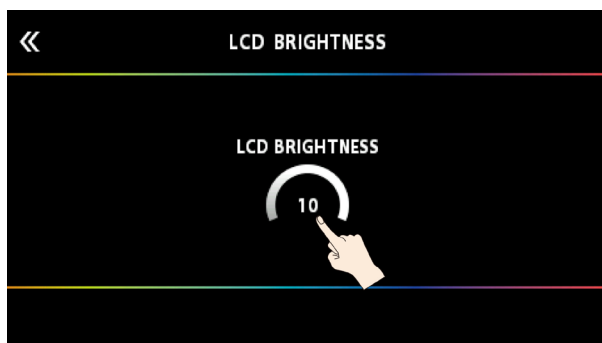

MEMO

Use either the [1]–[4] knobs below the screen or the [SELECT] knob to edit the value.

Restoring the Factory Settings (Factory Reset)

Restoring the GX-100's settings to their original factory settings is referred to as "Factory Reset." You can restore all of the settings to their factory-set values, and you can also specify certain items to be reset.

* When you execute "Factory Reset," the settings you made are lost. Save the data you need to your computer using the dedicated software.

1. Press the [MENU] button.



2. Touch <FACTORY RESET>.

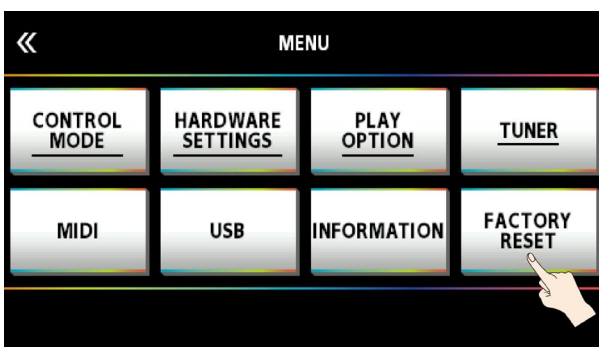

3. Specify the factory reset range by using the [1], [2] knobs to set <FROM> and <TO>.

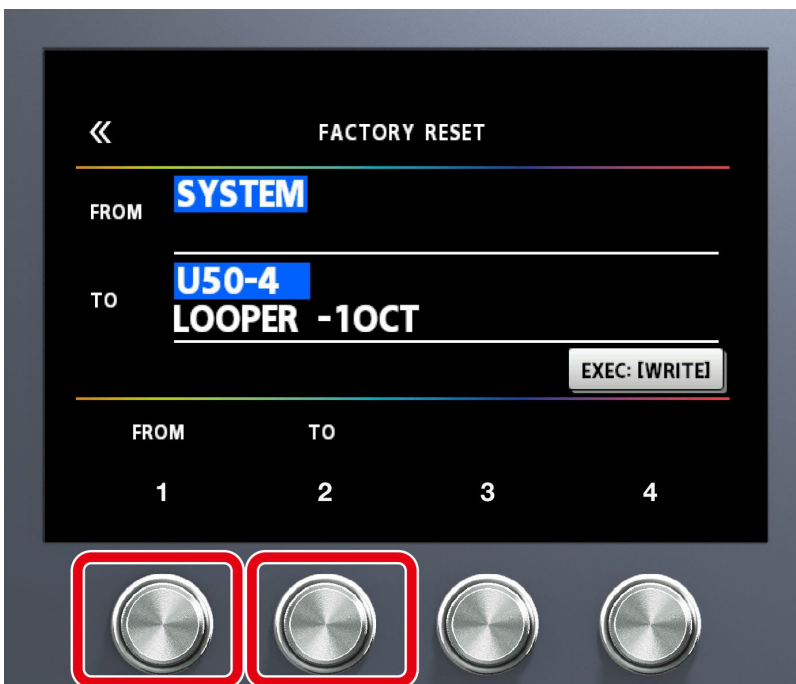

Parameter	Value	Explanation
FROM, TO	SYSTEM	System parameter settings
	U01-1-U50-5	Settings for Memory Numbers U01-1-U50-4

MEMO

You can also use the [1] knob below the screen to set the "FROM" value.
You can also use the [4] knob below the screen to set the "TO" value.

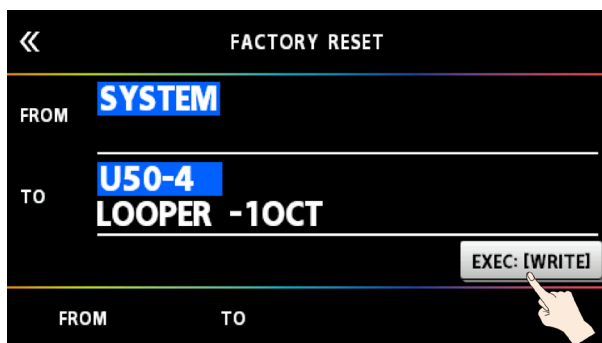
4. Touch <EXEC: [WRITE]>.

A confirmation message appears.



Touch <OK> to execute the factory reset.

To cancel factory reset, touch <CANCEL>.

Once the Factory Reset is complete, you are returned to the Play screen.

Turning Off the Auto Off Function

The GX-100 will turn off automatically when 10 hours have passed since you last played or operated the unit (Auto off function). The display will show a message approximately 15 minutes before the power turns off.

With the factory settings, this function is turned "ON" (power-off in 10 hours). If you want to have the power remain on all the time, turn it "OFF."

1. Press the [MENU] button.



2. Touch <HARDWARE SETTINGS>.

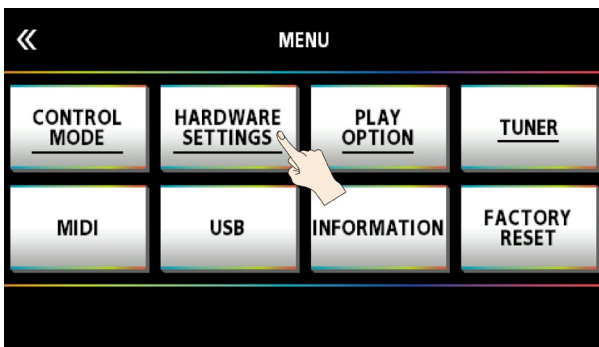

3. Touch <AUTO OFF>.

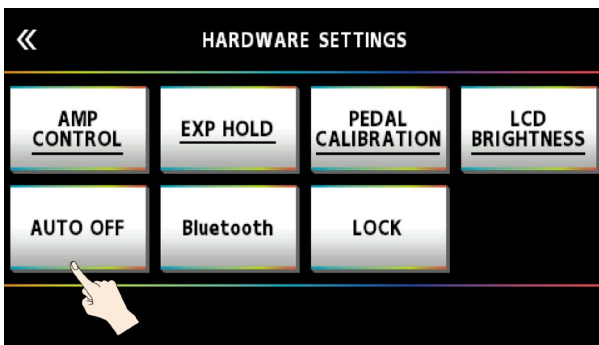

4. Touch <OFF>.

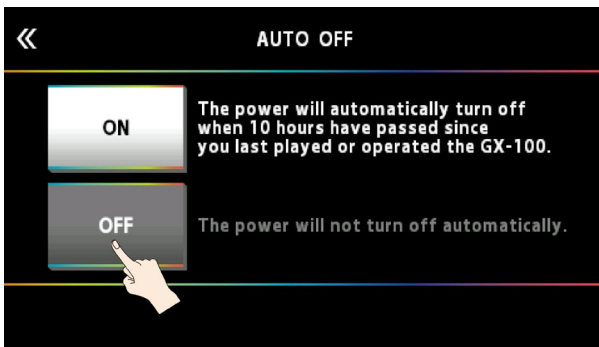

The screen switches to the one shown below, and the function that automatically turns off the power is disabled.

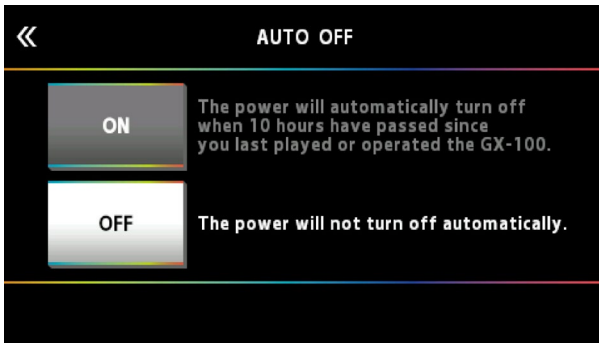

5. Press the [EXIT] button a number of times to return to the play screen.

Connecting to a Computer

By connecting the GX-100 to a computer via USB, you can do the following.

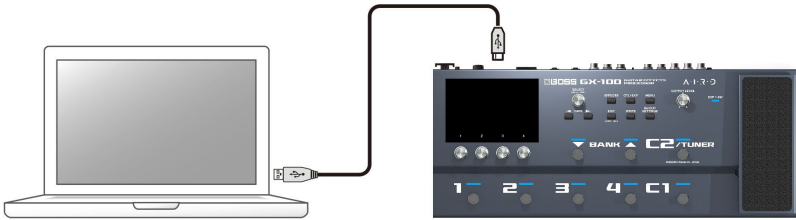

- **Transmit and receive digital audio signals between the computer and the GX-100**
- **Edit and manage memories, and display the “GX-100 Parameter Guide” on a computer using the dedicated software**
- **Download memories from our dedicated BOSS TONE CENTRAL website**
→ <http://bosstonecentral.com/>

Installing the USB Driver

You must install the USB driver before connecting to a computer.

Download the USB driver from the website shown below.

Install this special driver before making a USB connection. For further details, refer to the Readme.htm file that comes with the download.

→ <http://www.boss.info/support/>

The program you need to use, and the steps you need to take to install the USB driver will differ depending on your computer setup, so please carefully read and refer to the Readme.htm file that comes with the download.

Using the GX-100 as an Audio Interface

You can record the sound of the GX-100 on your computer, or have sound from your computer be output from the OUTPUT jacks.

- * Refer to the instruction manual for the software you are using to learn how to switch the input source of the software.

Making use of the GX-100’s dedicated software

Please download the dedicated software from the website shown below. For details on how to use the software, refer to the Readme.htm file that comes with the download.

→ <http://www.boss.info/support/>

Using the dedicated software allows you to do the following:

- **Easily download memories from our BOSS TONE CENTRAL website.**
- **Edit memory settings**
- **You can assign a name to a memory.**
- **Organize memories in order and switch them around**
- **Back up memories and system settings, and return to the backed up settings**
- **You can bring up the manuals for this unit, including the “GX-100 Startup Guide,” the “GX-100 Reference Manual” (this manual) and the “GX-100 Parameter Guide.”**

Connecting with an External MIDI Device

On the GX-100, you can use MIDI to perform the following operations.

* For details on MIDI, refer to “GX-100Parameter Guide.”

Operations from the GX-100

Operation	Explanation
Transmit program change messages	When you select a memory on the GX-100, the program change message specified by MEMORY MIDI is also transmitted. The external MIDI device that receives this program change message will switch to the corresponding settings.
Transmit control change messages	When you operate the [C1]–[C2] switches or the footswitches or expression pedals connected to the CTL 3, 4/EXP 2 jack, this is output as a control change message. These messages can control parameters on an external MIDI device.

Operations from an External MIDI Device

Operation	Explanation
Switch memory numbers	When the GX-100 receives a program change message from an external MIDI device, the GX-100 will change memories.
Receiving Control Change messages	The GX-100 can receive control change messages to control a specified parameter while you perform.
Receive data	The GX-100 can receive data that is transmitted from another GX-100 unit, or data that was saved on a MIDI sequencer.

Connection example



Settings

1. Following the steps in “4.1. Basic MENU Operations(P.35),” select the sub-menu item in [MENU] → <MIDI> →.
2. If you’ve selected “MIDI SETTINGS” in the sub-menu, drag the parameter icon up/down to change the value.

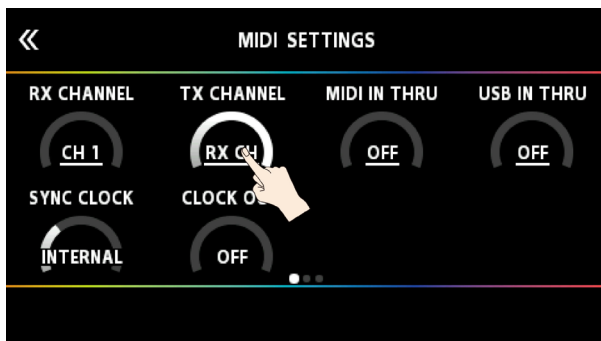

If you’ve selected “PROGRAM MAP” in the sub-menu, use knobs [1]–[4] to change the values.

PROGRAM MAP PROG

	BANK 1	BANK 2	BANK 3
PC# 1	U01-1	U26-1	P01-1
PC# 2	U01-2	U26-2	P01-2
PC# 3	U01-3	U26-3	P01-3
PC# 4	U01-4	U26-4	P01-4
PC# 5	U02-1	U27-1	P02-1

PC # MEMORY # MEMORY # MEMORY #

Wireless Connection with a Mobile Device

Attach the Bluetooth® Audio MIDI Dual Adaptor (BT-DUAL, sold separately) to the GX-100 to wirelessly play back music on your mobile device, or to edit the effects of this unit from the app on your mobile device.

- * Note that the GX-100 does not offer Bluetooth functionality. You'll need to attach the BT-DUAL (sold separately) to use Bluetooth.

Attaching the BT-DUAL

Attach the BT-DUAL to the Bluetooth ADAPTOR jack of the GX-100.

1. **Power down the GX-100 and unplug the AC adaptor from the AC outlet.**
2. **Remove the cover and screw from the Bluetooth ADAPTOR jack on the rear panel.**

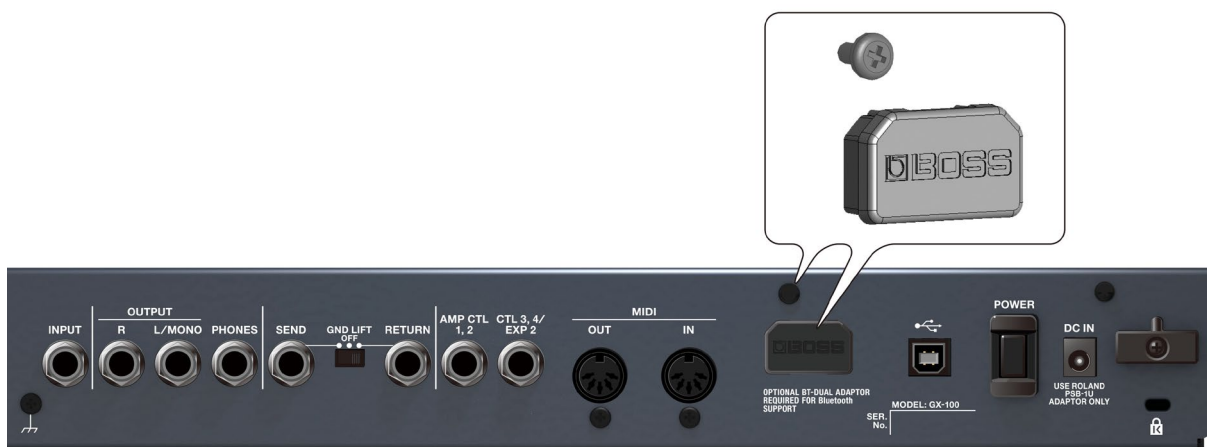

3. **Attach the BT-DUAL and fasten the screw that you removed in step 2 in place.**

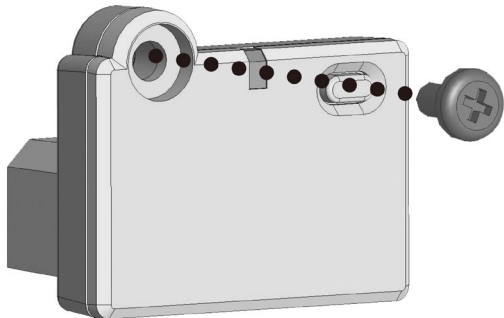

NOTE

- Be sure to use only the screw that was originally mounted on the Bluetooth ADAPTOR jack. If you use a different screw, the unit may malfunction.
- Do not touch the circuitry or the jacks.
- After you have attached the BT-DUAL, check again whether it is properly installed.

Listening to Sound via Wireless Connection with a Mobile Device

Bluetooth® audio functionality

You can output music played from your Bluetooth audio-capable mobile device from the OUTPUT jacks or the PHONES jack of the GX-100.

Registering a Mobile Device (Pairing)

“Pairing” involves registering the mobile device that you want to use with the GX-100 (making the two devices recognize each other).

Here we’ll configure the settings so that music data saved on your mobile device can be played wirelessly via the GX-100.

MEMO

The following explanation is only one example. For details, refer to the owner’s manual of your mobile device.

1. Turn on the power of the GX-100.
2. Place the mobile device that you want to connect close to the GX-100.
3. Hold down the pairing button on the BT-DUAL until the Bluetooth indicator blinks rapidly.



4. Turn on the Bluetooth function of the mobile device.

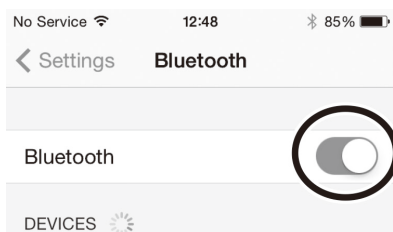

MEMO

This explanation uses the iPhone as an example. For details, refer to the owner’s manual of your mobile device.

5. Tap “GX-100 Audio” or “GX-100 MIDI” shown on the Bluetooth device screen of your mobile device.

This pairs the BT-DUAL with your mobile device. When pairing succeeds, “GX-100 Audio” is added to the list of “Paired Devices” on your mobile device.

* If you don’t complete the pairing within a certain time, the Bluetooth indicator goes dark and the unit exits pairing standby mode.

Connecting an Already-Paired Mobile Device

1. With the BT-DUAL’s Bluetooth indicator off, press the pairing button.
2. Turn on the Bluetooth function of the mobile device.

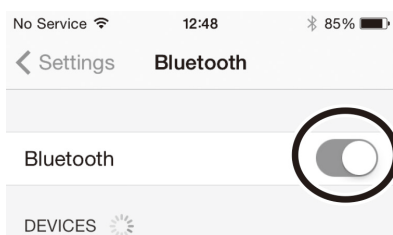

MEMO

- If you were unable to connect using the steps above, tap “GX-100 Audio,” displayed in the Bluetooth device screen of the mobile device.
- To disconnect, press the pairing button on the BT-DUAL to make the Bluetooth indicator go dark, or turn off the mobile device’s Bluetooth function.

Disabling Bluetooth Functionality

If you want to disconnect the Bluetooth connection between the BT-DUAL and your mobile device, disable Bluetooth functionality.

- 1. Press the pairing button on the BT-DUAL.**

The Bluetooth indicator goes dark.

Controlling the GX-100 from a Mobile Device App

Use the “GX-100 Editor” app to edit effects and save settings on this unit.

For details on the GX-100 Editor, see the BOSS website.

<https://www.boss.info/>

Connecting to the App

Here are the settings to make in order to use an app on your mobile device.

* Make the connection from the app’s settings, not from your mobile device’s Bluetooth settings.

1. **Turn on the power of the GX-100.**
2. **Place the mobile device that you want to connect close to the GX-100.**
3. **Turn on the Bluetooth function of the mobile device.**

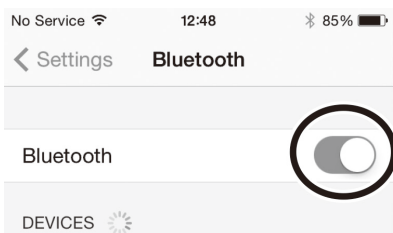

When Bluetooth audio is connected, the Bluetooth indicator on the BT-DUAL lights up. Note that the unit has not finished connecting with the app at this time.

MEMO

This explanation uses the iPhone as an example. For details, refer to the owner’s manual of your mobile device.

4. **In the app’s settings, connect to GX-100 MIDI.**

NOTE

Do not tap “GX-100 AUDIO 1,” “GX-100 MIDI 1” or similar indications shown in the Bluetooth settings of your mobile device.

Footswitch and Expression Pedal Settings

You can assign a variety of functions to each of the top panel footswitches, the expression pedal (EXP1), and the expression pedal or footswitch connected to the rear panel CTL 3, 4/EXP 2 jack.

Assigning a Function

1. Press the [CTL/EXP] button.

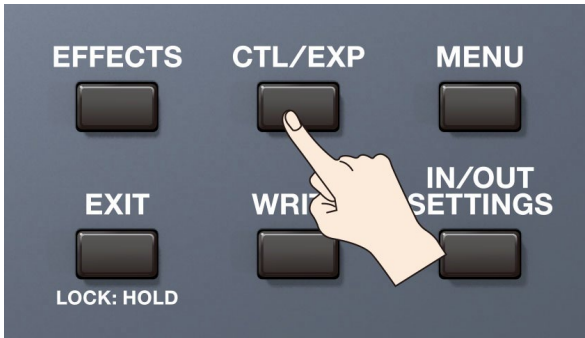

2. Touch <CONTROL FUNCTION>.

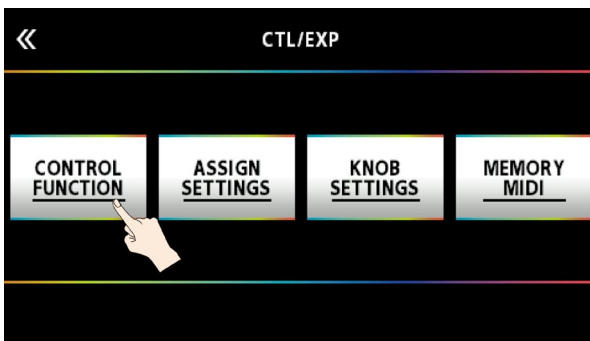

3. Turn the [SELECT] knob to select the item that you want to set.

Turning the knob will move the selected item vertically.



4. Turn knobs [1]–[4] to edit the value of the item selected for each switch.

* The footswitch and expression pedal functions must be specified for each memory; however, if you set "PREF (PREFERENCE)" to SYSTEM, all memories will use those functions in common.

MEMO

The GX-100 lets you arrange multiple pedal effects in the effect chain like FOOT VOLUME, WAH and so on. In CONTROL FUNCTION, the pedal effect placed at the beginning of the chain (or at "A CH" in DIV/MIX) is enabled.

ASSIGN SETTING

ASSIGN 1–20

For each parameter, you can specify, in detail, which controller will control which parameter. You can create 20 sets of such assignments.

1. Press the [CTL/EXP] button.

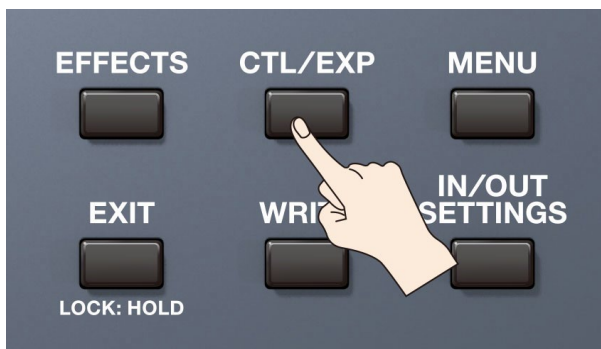

2. Touch <ASSIGN SETTINGS>.

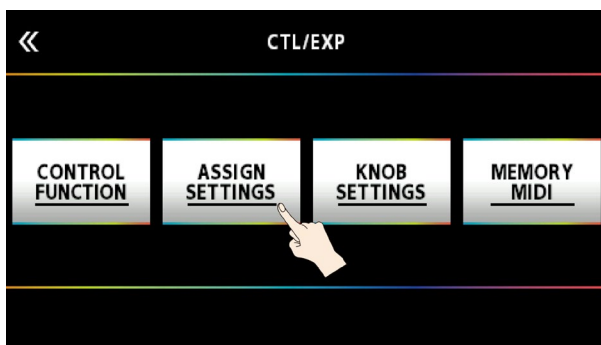

The ASSIGN SETTINGS screen appears.

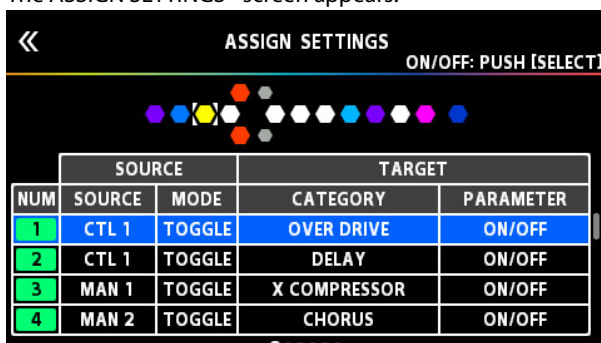

3. Turn the [SELECT] knob to select ASSIGN NUMBER (NUM).

Turning the knob will move the selected item vertically.

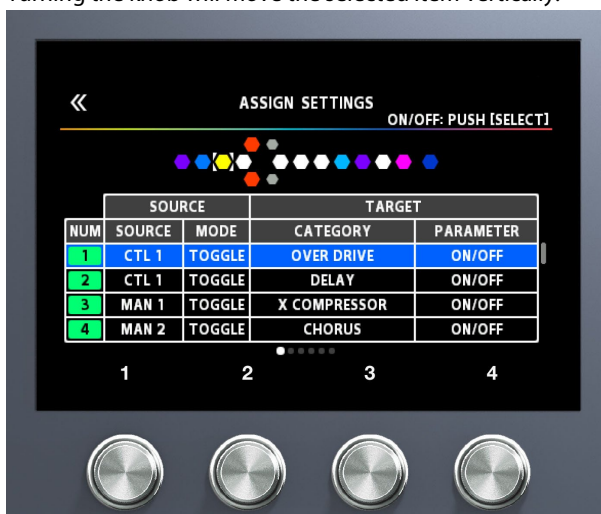

4. Use knobs [1]–[4] to select parameters or edit the values. Switch between pages using the PAGE [◀] [▶] buttons.

Page 1

SOURCE		TARGET		
NUM	SOURCE	MODE	CATEGORY	PARAMETER
1	CTL 1	TOGGLE	OVER DRIVE	ON/OFF
2	CTL 1	TOGGLE	DELAY	ON/OFF
3	MAN 1	TOGGLE	X COMPRESSOR	ON/OFF
4	MAN 2	TOGGLE	CHORUS	ON/OFF

Page 2

SOURCE		TARGET		
NUM	ACT LOW	ACT HIGH	MIN	MAX
1	0	127	OFF	ON
2	0	127	OFF	ON
3	0	127	OFF	ON
4	0	127	OFF	ON

Page 3

INTERNAL PEDAL			
NUM	TRIGGER	TIME	CURVE
1	----	----	----
2	----	----	----
3	----	----	----
4	----	----	----

Page 4

WAVE PEDAL		INPUT	
NUM	FORM	RATE	SENS
1	----	----	----
2	----	----	----
3	----	----	----
4	----	----	----

Page 5







MIDI		TARGET MIDI CC#		
NUM	CH	CC#	MIN	MAX
1	----	----	----	----
2	----	----	----	----
3	----	----	----	----
4	----	----	----	----

Page 6

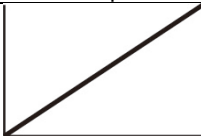
TARGET PC#			
NUM	PC	BANK MSB	BANK LSB
1	----	----	----
2	----	----	----
3	----	----	----
4	----	----	----

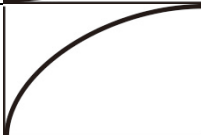
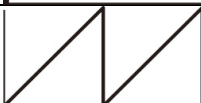
5. Press the [SELECT] knob to turn the selected ASSIGN NUMBER (NUM) on/off.

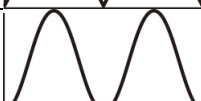
Parameter	Value	Explanation
SW	OFF, ON	Turns the ASSIGN 1–20 on/off.
TARGET	TARGET(P.53)	This selects the parameter to be changed.
	MIN	This sets the minimum value for the range in which the parameter can change. The value differs depending on the parameter assigned for TARGET parameter.
	MAX	This sets the maximum value for the range in which the parameter can change. The value differs depending on the parameter assigned for TARGET parameter.
SOURCE	SOURCE	NUM 1–NUM 4 Assigns the number switches [1]–[4] on this unit when set to memory mode.
	MAN 1–MAN 4	Assigns the number switches [1]–[4] on this unit when set to manual mode.
	CUR NUM	Assigns the same number switch as the selected memory number.
	BANK ▲	Assigns the GX-100's BANK [▲] switch.
	BANK ▼	Assigns the GX-100's BANK [▼] switch.
	CTL 1, CTL 2	Assigns the GX-100's [C1]–[C2] switch.
	CTL 3, CTL 4	Assigns the external footswitch connected to the CTL 3, 4/ EXP 2 jack.
	EXP 1 SW	Assigns the GX-100's [EXP 1] switch.
	EXP 1	Assigns the GX-100's expression pedal.
	EXP 2	Assigns the external expression pedal connected to the CTL 3, 4/ EXP 2 jack.
	INT PDL	Assigns the internal pedal. Refer to "8.1.3. Virtual Expression Pedal System (Internal Pedal / Wave Pedal)(P.66)"
	WAVE PDL	Assigns the wave pedal.
	INPUT	The assigned target parameter will change according to the input level.
	CC# 1–31, 64–95	Control Change messages from an external MIDI device.
	MODE	MOMENT
TOGGLE		The setting is toggled On (maximum value) or Off (minimum value) with each press of the footswitch.
ACT LOW	0–126	You can set the controllable range for target parameters within the source's operational range. Target parameters are controlled within the range set with ACT LOW and ACT HIGH. You should normally set ACT LOW to 0 and ACT HIGH to 127.
ACT HIGH	1–127	
SENS	0–100	
INTERNAL PEDAL(P.66)	TRIGGER *1	MEM_CHANGE This is activated when a memory is selected.
	EXP1 PDL-LOW	This is activated when the GX-100's expression pedal is set to the minimum position.
	EXP1 PDL-MID	This is activated when the GX-100's expression pedal is moved through the middle position.
	EXP1 PDL-HIGH	This is activated when the GX-100's expression pedal is set to the maximum position.
	EXP1 SW	This is activated when the [EXP 1] switch is operated.

Parameter	Value	Explanation	
	NUM1–NUM4	This is activated when the [1]–[4] switch is operated.	
	CUR NUM	This is activated when you operate the same number switch as the selected memory number.	
	EXP 2	This is activated when an external expression pedal connected to the CTL 3, 4/ EXP 2 jack.	
	CTL 1, CTL 2	This is activated when the [C1]–[C2] switch is operated.	
	CTL 3, CTL 4	This is activated when an external footswitch connected to the CTL 3, 4/ EXP 2 jack is operated.	
	BANK ▲	This is activated when the BANK [▲] switch is operated.	
	BANK ▼	This is activated when the BANK [▼] switch is operated.	
	CC#1–31, 64–95	This is activated when a control change is received.	
	TIME *1	0–100	This specifies the time over which the internal pedal will move from the toe-raised position to the toe-down position.
	CURVE *1	LINEAR	
SLOW RISE			
FAST RISE			
WAVE PEDAL (P.66)	FORM *2	SAW	
		TRI	
		SINE	
	RATE *2	0–100, BPM 	This determines the time spend for one cycle of the assumed EXP Pedal.
		<p>* When set to BPM, the value of each parameter will be set according to the value of the “MASTER BPM” specified for each memory. This makes it easier to achieve effect sound settings that match the tempo of the song.</p> <p>* If, due to the tempo, the time is longer than the range of allowable settings, it is then synchronized to a period either 1/2 or 1/4 of that time.</p>	
MIDI	CH *3 *4	SYSTEM	Transmits a message on the MIDI channel specified by the parameter TX CHANNEL in “MIDI SETTING.”
		1–16	The message is transmitted on the specified MIDI channel.
TARGET MIDI CC# *3	CC#	0–127	The message is transmitted using the specified controller number.
	MIN	0–127	Selects the minimum value of the transmitted CC# message.
	MAX	0–127	Selects the maximum value of the transmitted CC# message.
TARGET MIDI PC# *4	PC#	1–128	Specifies the program number that is transmitted.
	MSB	OFF, 0–127	Specifies the bank select MSB that is transmitted. If this is OFF, the bank select MSB is not transmitted.
	LSB	OFF, 0–127	Specifies the bank select LSB that is transmitted. If this is OFF, the bank select LSB is not transmitted.

*1 The INTERNAL PEDAL TRIGGER, INTERNAL PEDAL TIME, and INTERNAL PEDAL CURVE parameters are enabled when the SOURCE parameter is set to INT PEDAL.

*2 The WAVE PEDAL FORM and WAVE PEDAL RATE parameters are enabled when the Source parameter is set to WAVE PEDAL.

*3 The MIDI CH, TARGET MIDI CC# parameters are enabled when the TARGET is set to MIDI CC.

*4 The MIDI CH, TARGET MIDI PC# parameters are enabled when the TARGET is set to MIDI PC.

Making Assignments from the Effect Edit Screen (Quick Assign)

In the [effect edit screen](#) (P.23), you can select an effect parameter and assign that parameter to the switch of your choice.

1. Touch <EFFECTS> in the upper left of the screen (or press the [EFFECTS] button).

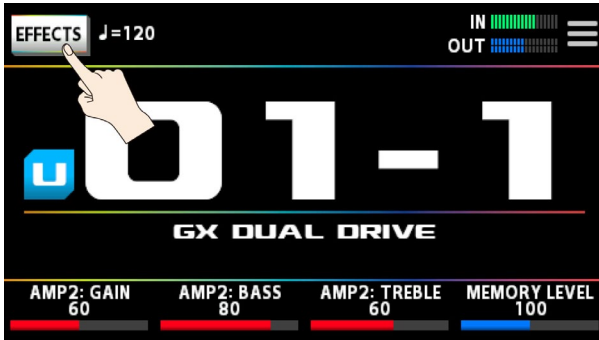

2. Touch the icon of the effect you want to edit.
3. Long-press the knob [1]–[4] for the parameter that you want to assign.

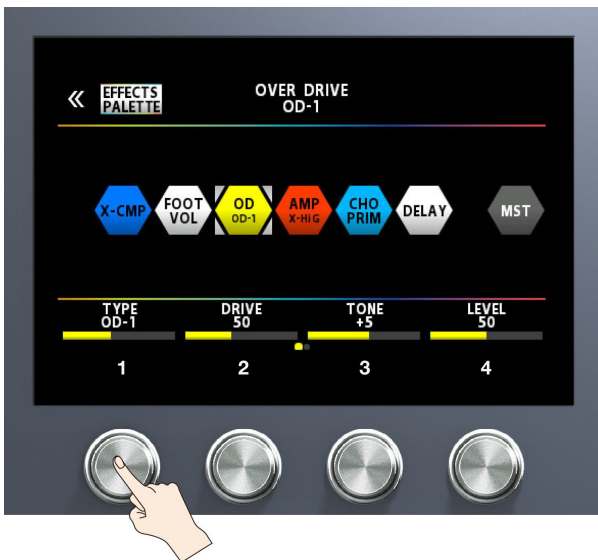

The ASSIGN SETTINGS screen appears.

The display automatically jumps to the ASSIGN NUMBER (NUM) that's off.

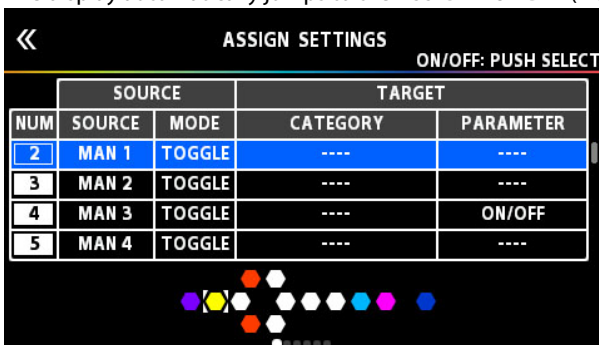

4. Press [SELECT] knob to turn the SW on.
5. Turn knobs [2]–[4] to edit parameters.

If necessary, use the PAGE [◀] [▶] buttons to switch between pages of settings.

Use SOURCE to specify the pedal or MIDI message that you will operate.

TARGET list

CATEGORY	TARGET
COMPRESSOR	ON/OFF
	TYPE
	SUSTAIN
	ATTACK
	LEVEL
	tone
	DIRECT MIX
X-COMPRESSOR	ON/OFF
	SUSTAIN
	ATTACK
	LEVEL
	tone
	RATIO
	DIRECT MIX
BOOSTER	ON/OFF
	TYPE
	BOOST
	tone
	LEVEL
	BOTTOM
	DIRECT MIX
	SOLO SW
	SOLO LEVEL
OVER DRIVE	ON/OFF
	TYPE
	DRIVE
	tone
	LEVEL
	BOTTOM
	DIRECT MIX
	SOLO SW
	SOLO LEVEL
X OVER DRIVE	ON/OFF
	DRIVE
	tone
	BOTTOM
	LEVEL
	DIRECT MIX
	SOLO SW
	SOLO LEVEL
	DISTORTION
TYPE	
DIST	
tone	
EFFECT LEVEL	
BOTTOM	
DIRECT MIX	
SOLO SW	
SOLO LEVEL	
X-DISTORTION	ON/OFF
	DRIVE
	tone
	BOTTOM
	LEVEL
	DIRECT
	SOLO SW
	SOLO LEVEL
	METAL DISTORTION
TYPE	
DRIVE	
tone	
LEVEL	
BOTTOM	

CATEGORY	TARGET
	DIRECT MIX
	SOLO SW
	SOLO LEVEL
FUZZ	ON/OFF
	TYPE
	FUZZ
	tone
	LEVEL
	BOTTOM
	DIRECT MIX
	SOLO SW
	SOLO LEVEL
PREAMP	ON/OFF
	TYPE
	GAIN
	LEVEL
	BASS
	MIDDLE
	TREBLE
	PRESENCE
	GAIN SW
	SOLO SW
	SOLO LEVEL
	BRIGHT SW
	SAG
	RESONANCE
	SP TYPE
	DIRECT MIX
	MIC TYPE
MIC DISTANCE	
MIC POSITION	
MIC LEVEL	
PARAMETRIC EQUALIZER	ON/OFF
	LOW GAIN
	HIGH GAIN
	LEVEL
	LOW-MID FREQ
	LOW-MID Q
	LOW-MID GAIN
	HIGH-MID FREQ
	HIGH-MID Q
	HIGH-MID GAIN
	LOW CUT
	HIGH CUT
GRAPHIC EQUALIZER	ON/OFF
	31.5 Hz
	63 Hz
	125 Hz
	250 Hz
	500 Hz
	1 kHz
	2 kHz
	4 kHz
	8 kHz
	16 kHz
	LEVEL
CHORUS	ON/OFF
	TYPE
	DIRECT LEVEL
	RATE
	DEPTH
	EFFECT LEVEL
LOW CUT	

CATEGORY	TARGET
	HIGH CUT
	PRE-DELAY
	WAVEFORM
	1: RATE
	1: DEPTH
	1: EFFECT LEVEL
	1: PRE-DELAY
	1: WAVEFORM
	1: LOW CUT
	1: HIGH CUT
	2: RATE
	2: DEPTH
	2: EFFECT LEVEL
	2: PRE-DELAY
	2: WAVEFORM
	2: LOW CUT
	2: HIGH CUT
OUTPUT MODE	
PRIME CHORUS	ON/OFF
	RATE
	DEPTH
	EFFECT LEVEL
	PRE-DELAY
	WAVEFORM
	LOW CUT
	HIGH CUT
	SWEETNESS
	BELL
OUTPUT MODE	
FLANGER	ON/OFF
	RATE
	DEPTH
	RESONANCE
	MANUAL
	STEP RATE
	LOW CUT
	HIGH CUT
	EFFECT LEVEL
PRIME FLANGER	ON/OFF
	RATE
	DEPTH
	RESONANCE
	MANUAL
	TURBO
	WAVE FORM
	STEP RATE
	SEPARATION
	EFFECT LEVEL
	LOW DAMP
	HIGH DAMP
	DIRECT MIX
	LOW CUT
HIGH CUT	
PHASER	ON/OFF
	STAGE
	RATE
	DEPTH
	RESONANCE
	MANUAL
	STEP RATE
EFFECT LEVEL	
DIRECT MIX	
SCRIPT PHASER	ON/OFF

CATEGORY	TARGET
	RATE
	DEPTH
	EFFECT LEVEL
	DIRECT MIX
PRIME PHASER	ON/OFF
	STAGE
	RATE
	DEPTH
	RESONANCE
	MANUAL
	WAVE FORM
	STEP RATE
	BI-PHASE
	SEPARATION
	LOW DAMP
	HIGH DAMP
	LOW CUT
	HIGH CUT
	EFFECT LEVEL
DIRECT MIX	
CLASSIC VIBE	ON/OFF
	MODE
	RATE
	DEPTH
	LEVEL
ROTARY	DIRECT MIX
	SPEED SELECT
	SLOW RATE
	FAST RATE
	EFFECT LEVEL
	RISE TIME
	FALL TIME
	MIC DISTANCE
	ROTOR/HORN
	DRIVE
DIRECT MIX	
VIBRATO	ON/OFF
	RATE
	DEPTH
	TRIGGER
	RISE TIME
	EFFECT LEVEL
PRIME VIBRATO	ON/OFF
	RATE
	DEPTH
	COLOR
	EFFECT LEVEL
	TRIGGER
	RISE TIME
	DIRECT MIX
TREMOLO	ON/OFF
	RATE
	DEPTH
	WAVE FORM
	EFFECT LEVEL
	TRIGGER
	RISE TIME
	DIRECT MIX
PAN	ON/OFF
	RATE
	DEPTH
	WAVE FORM
	EFFECT LEVEL

CATEGORY	TARGET
RING MODULATOR	DIRECT MIX
	ON/OFF
	INTELLIGENT
	FREQUENCY
	MOD RATE
	MOD DEPTH
	EFFECT LEVEL
PITCH SHIFTER	DIRECT MIX
	ON/OFF
	VOICE
	DIRECT LEVEL
	1: PITCH
	1: MODE
	1: FINE
	1: PRE-DELAY
	1: LEVEL
	1: FEEDBACK
	2: PITCH
	2: MODE
	2: FINE
	2: PRE-DELAY
	2: LEVEL
HARMONIST	ON/OFF
	VOICE
	1: HARMONY
	1: LEVEL
	1: PRE-DELAY
	1: FEEDBACK
	2: HARMONY
	2: LEVEL
	2: PRE-DELAY
	DIRECT LEVEL
	1: C
	1: D ^b
	1: D
	1: E ^b
	1: E
	1: F
	1: F [#]
	1: G
	1: A ^b
	1: A
	1: B ^b
	1: B
	2: C
	2: D ^b
	2: D
	2: E ^b
	2: E
	2: F
	2: F [#]
	2: G
	2: A ^b
	2: A
	2: B ^b
2: B	
OVERTONE	ON/OFF
	LOWER LEVEL
	UPPER LEVEL
	UNISON LEVEL
	DIRECT LEVEL
	DETUNE
OUTPUT MODE	

CATEGORY	TARGET	
	LOW	
	HIGH	
OCTAVE	ON/OFF	
	-2 OCT	
	-1 OCT	
	DIRECT LEVEL	
POLY OCTAVE	ON/OFF	
	RANGE	
	OCTAVE LEVEL	
	DIRECT LEVEL	
DELAY	ON/OFF	
	TIME	
	FEEDBACK	
	HIGH CUT	
	EFFECT LEVEL	
	DIRECT LEVEL	
	HIGH CUT	
	BPM	
	CARRYOVER	
	DELAY PLUS	ON/OFF
TYPE		
DIRECT LEVEL		
MOD RATE		
MOD DEPTH		
DUCK SENS		
DUCK PRE DEPTH		
DUCK POST DEPTH		
CARRYOVER		
TIME		
FEEDBACK		
EFFECT LEVEL		
HIGH CUT		
TAP TIME		
AUTO TRIGGER		
MODE		
1: TYPE		
1: TIME		
1: FEEDBACK		
1: EFFECT LEVEL		
1: HIGH CUT		
2: HIGH CUT		
2: TYPE		
2: TIME		
2: FEEDBACK		
2: EFFECT LEVEL		
ANALOG DELAY		ON/OFF
		TYPE
	TIME	
	FEEDBACK	
	EFFECT LEVEL	
	DIRECT LEVEL	
	HIGH CUT	
	MOD RATE	
	MOD DEPTH	
	DUCK SENS	
	DUCK PRE	
	DUCK POST	
	CARRYOVER	
SPACE ECHO	ON/OFF	
	TIME	
	FEEDBACK	
	EFFECT LEVEL	
	DIRECT LEVEL	

CATEGORY	TARGET
	HIGH CUT
	MOD RATE
	MOD DEPTH
	DUCK SENS
	DUCK PRE
	DUCK POST
	HEAD
	WOW FLUTTER
	CARRYOVER
	ON/OFF
SHIMMER DELAY	TIME
	FEEDBACK
	EFFECT LEVEL
	DIRECT LEVEL
	HIGH CUT
	MOD RATE
	MOD DEPTH
	DUCK SENS
	DUCK PRE
	DUCK POST
	PITCH
	PITCH BALANCE
	PITCH FEEDBACK
	CARRYOVER
ON/OFF	
TERA ECHO	MODE
	SPREAD TIME
	FEEDBACK
	EFFECT LEVEL
	TONE
	DIRECT LEVEL
	TRIGGER
	CARRYOVER
	ON/OFF
TWIST	MODE
	TRIGGER
	LEVEL
	RISE TIME
	FALL TIME
	FADE TIME
	CARRYOVER
	ON/OFF
WARP	TIME
	TRIGGER
	LEVEL
	CARRYOVER
REVERB	ON/OFF
	TYPE
	TIME
	PRE-DELAY
	EFFECT LEVEL
	DENSITY
	LOW CUT
	HIGH CUT
	DIRECT LEVEL
	CARRYOVER
REVERB PLUS	ON/OFF
	TYPE
	TIME
	TONE
	EFFECT LEVEL
	DENSITY
PRE-DELAY	

CATEGORY	TARGET	
	LOW CUT	
	HIGH CUT	
	LOW DAMP	
	HIGH DAMP	
	MOD RATE	
	MOD DEPTH	
	DUCK SENS	
	DUCK PRE	
	DUCK POST	
	DIRECT LEVEL	
	CARRYOVER	
	SHIMMER REVERB	ON/OFF
		TIME
TONE		
EFFECT LEVEL		
DENSITY		
PRE-DELAY		
LOW CUT		
HIGH CUT		
LOW DAMP		
HIGH DAMP		
MOD RATE		
MOD DEPTH		
DUCK SENS		
DUCK PRE		
DUCK POST		
DIRECT LEVEL		
1: PITCH		
2: PITCH		
1: LEVEL		
2: LEVEL		
CARRYOVER		
AC GUITAR SIM	ON/OFF	
	BODY	
	LOW	
	HIGH	
	LEVEL	
AC RESONANCE	ON/OFF	
	TYPE	
	RESONANCE	
	TONE	
SLOW GEAR	LEVEL	
	ON/OFF	
	SENS	
	RISE TIME	
DEFRETTER	LEVEL	
	ON/OFF	
	SENS	
	DEPTH	
	TONE	
	EFFECT LEVEL	
	ATTACK	
	RESONANCE	
	DIRECT MIX	
TOUCH WAH	ON/OFF	
	FILTER MODE	
	POLARITY	
	SENS	
	FREQUENCY	
	RESONANCE	
	DECAY	
	EFFECT LEVEL	
DIRECT MIX		

CATEGORY	TARGET
S-BEND	ON/OFF
	TRIGGER
	PITCH
	RISE TIME
	FALL TIME
WAH	ON/OFF
	WAH TYPE
	PEDAL POSITION
	PEDAL MIN
	PEDAL MAX
	EFFECT LEVEL
DIRECT MIX	
PEDAL BEND	ON/OFF
	PITCH MIN
	PITCH MAX
	PEDAL POSITION
	EFFECT LEVEL
	DIRECT MIX
FOOT VOLUME	ON/OFF
	PEDAL POSITION
	VOLUME MIN
	VOLUME MAX
NOISE SUPPRESSOR	CURVE
	ON/OFF
	THRESHOLD
	RELEASE
DIVIDER	DETECT
	MODE
	CH SELECT
	MIX MODE
	A: DYNAMIC
	A: DYNAMIC SENS
	A: FILTER
	A: CUTOFF FREQ
	B: DYNAMIC
	B: DYNAMIC SENS
	B: FILTER
B: CUTOFF FREQ	
MIXER	MODE
	A LEVEL
	B LEVEL
	A/B BALANCE
	SPREAD
SEND/RETURN	ON/OFF
	MODE
	SEND LEVEL
	RETURN LEVEL
	ADJUST
	INVERT
LOOP	LOOP LEVEL
BASS X-COMP	ON/OFF
	ATTACK
	LEVEL
	TONE
	RATIO
	DIRECT MIX
THRESHOLD	
BASS OVER DRIVE	ON/OFF
	DRIVE
	TONE
	EFFECT LEVEL
	BOTTOM
DIRECT MIX	

CATEGORY	TARGET	
X BASS OVERDRIVE	SOLO SW	
	SOLO LEVEL	
	ON/OFF	
	DRIVE	
	TONE	
	EFFECT LEVEL	
	BOTTOM	
	DIRECT MIX	
	SOLO SW	
	SOLO LEVEL	
BASS DISTORTION	ON/OFF	
	TYPE	
	DRIVE	
	TONE	
	EFFECT LEVEL	
	BOTTOM	
	DIRECT MIX	
	SOLO SW	
	SOLO LEVEL	
	BASS METAL DIST	ON/OFF
DIST		
TONE		
EFFECT LEVEL		
BOTTOM		
DIRECT MIX		
SOLO SW		
SOLO LEVEL		
BASS FUZZ		ON/OFF
		FUZZ
	TONE	
	EFFECT LEVEL	
	BOTTOM	
	DIRECT MIX	
	SOLO SW	
	SOLO LEVEL	
	BASS PREAMP	ON/OFF
		TYPE
GAIN		
LEVEL		
BASS		
MIDDLE		
TREBLE		
PRESENCE		
GAIN SW		
SOLO SW		
SOLO LEVEL		
BRIGHT SW		
SAG		
RESONANCE		
DIRECT MIX		
SP TYPE		
MIC TYPE		
MIC DISTANCE		
MIC POSITION		
MIC LEVEL		
BASS CHORUS	ON/OFF	
	TYPE	
	RATE	
	DEPTH	
	EFFECT LEVEL	
	LOW CUT	
	HIGH CUT	
	DIRECT LEVEL	

CATEGORY	TARGET
BASS FLANGER	ON/OFF
	RATE
	DEPTH
	RESONANCE
	MANUAL
	STEP RATE
	LOW CUT
	EFFECT LEVEL
	DIRECT MIX
BASS PRIME FLANGER	ON/OFF
	RATE
	DEPTH
	RESONANCE
	MANUAL
	TURBO
	WAVE FORM
	STEP RATE
	SEPARATION
	EFFECT LEVEL
	LOW DAMP
	HIGH DAMP
	DIRECT MIX
	LOW CUT
	HIGH CUT
BASS PHASER	ON/OFF
	STAGE
	RATE
	DEPTH
	RESONANCE
	MANUAL
	STEP RATE
	EFFECT LEVEL
	DIRECT MIX
BASS PRIME PHASER	ON/OFF
	STAGE
	RATE
	DEPTH
	RESONANCE
	MANUAL
	WAVE FORM
	STEP RATE
	BI-PHASE
	SEPARATION
	LOW DAMP
	HIGH DAMP
	LOW CUT
	HIGH CUT
	EFFECT LEVEL
DIRECT MIX	
BASS PITCH SHIFTER	ON/OFF
	VOICE
	DIRECT LEVEL
	1: PITCH
	1: MODE
	1: FINE
	1: PRE-DELAY
	1: LEVEL
	1: FEEDBACK
	2: PITCH
	2: MODE
	2: FINE
	2: PRE-DELAY
	2: LEVEL

CATEGORY	TARGET
BASS HARMONIST	ON/OFF
	VOICE
	1: HARMONY
	1: LEVEL
	1: PRE-DELAY
	1: FEEDBACK
	2: HARMONY
	2: LEVEL
	2: PRE-DELAY
	DIRECT LEVEL
	1: C
	1: D ^b
	1: D
	1: E ^b
	1: E
	1: F
	1: F [#]
	1: G
	1: A ^b
	1: A
	1: B ^b
	1: B
	2: C
	2: D ^b
	2: D
	2: E ^b
	2: E
	2: F
	2: F [#]
	2: G
	2: A ^b
	2: A
	2: B ^b
2: B	
BASS OCTAVE	ON/OFF
	-2 OCT
	-1 OCT
	DIRECT LEVEL
BASS SLOW GEAR	ON/OFF
	SENS
	RISE TIME
BASS DEFRETTER	LEVEL
	ON/OFF
	SENS
	ATTACK
	TONE
	EFFECT LEVEL
	DIRECT MIX
BASS TOUCH WAH	ON/OFF
	FILTER MODE
	POLARITY
	SENS
	FREQUENCY
	RESONANCE
	DECAY
	EFFECT LEVEL
DIRECT MIX	
BASS S-BEND	ON/OFF
	TRIGGER
	PITCH
	RISE TIME
	FALL TIME
BASS WAH	ON/OFF

CATEGORY	TARGET
	PEDAL POSITION
	PEDAL MIN
	PEDAL MAX
	EFFECT LEVEL
	DIRECT MIX
BASS PEDAL BEND	ON/OFF
	PITCH MIN
	PITCH MAX
	PEDAL POSITION
	EFFECT LEVEL
MASTER	DIRECT MIX
	MEMORY LEVEL
	BPM
	KEY
	INPUT SETTING
	AMP CTL1
TUNER	AMP CTL2
	ON/OFF
MIDI *	MIDI CC#
	MIDI PC#

* For more on categories aside from the effects, refer to the "GX-100 Parameter Guide."

* You can't assign MIDI parameters to the [1]–[4] knobs in "KNOB SETTING."

Virtual Expression Pedal System (Internal Pedal / Wave Pedal)

By assigning a desired parameter to the virtual expression pedal, you can produce an effect as though you were operating a physical expression pedal to change the volume or tone quality in real time.

The virtual expression pedal system provides the following two types of functions, and you can use the SOURCE setting for ASSIGN 1–20 to choose the desired type.

Internal pedal

If SOURCE is set to "INT PEDAL," the virtual expression pedal will begin operating when started by the specified trigger (TRIGGER), modifying the parameter specified by "TARGET".

The value changes in a curve

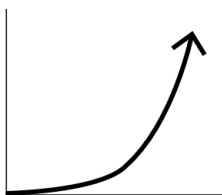

When the trigger occurs

Wave pedal

If SOURCE is set to "WAVE PDL," the virtual expression pedal will cyclically modify the parameter specified by TARGET in a fixed wave form.

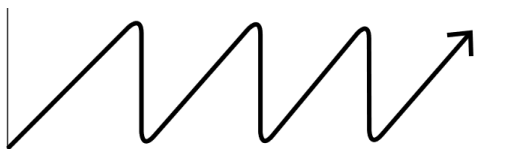

Always changes in a fixed curve regardless of the actual pedal

Adjusting the Expression Pedal (Pedal Calibration)

Although the GX-100's expression pedal has been set for optimum operation at the factory, extended use and the operating environment can result in the pedal going out of adjustment.

If you encounter problems such as being unable to fully cut off the sound with the volume pedal or being unable to switch the PEDAL FX, you can use the following procedure to readjust the pedal.

1. Press the [MENU] button.



2. Touch <HARDWARE SETTINGS>.

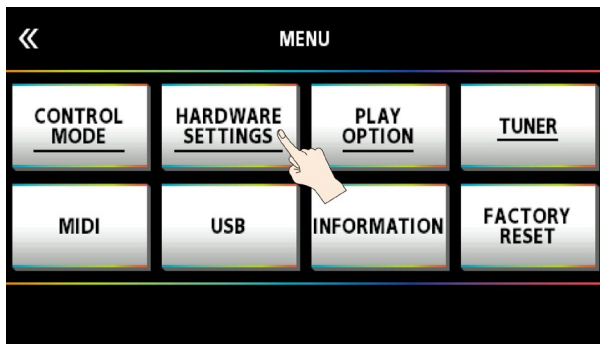

3. Touch <PEDAL CALIBRATION>.

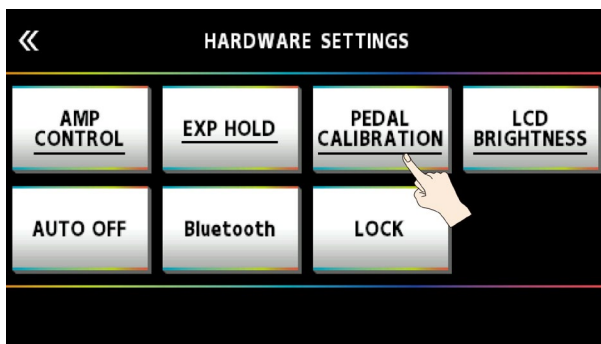

The PEDAL CALIBRATION screen appears.

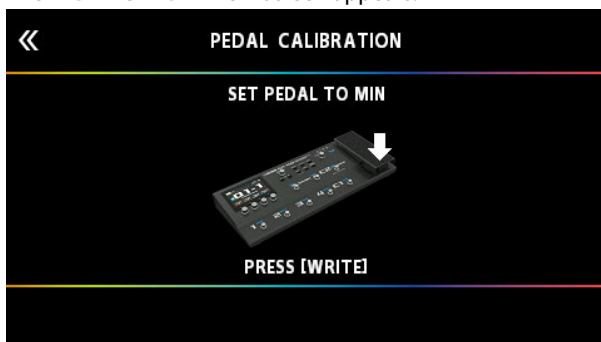

4. Press the heel end of the pedal, and press the [WRITE] button.

The screen will indicate "OK," and then a screen like the following will appear.



5. Press the toe end of the pedal, and press the [WRITE] button.

The screen will indicate "OK," and then a screen like the following will appear.

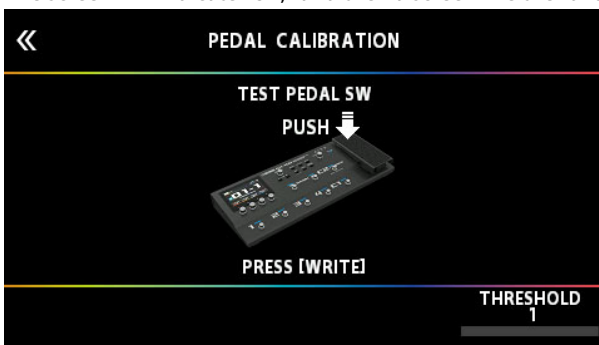

6. Strongly press the toe end of the pedal.

Verify that the PEDAL FX indicator lights when you strongly press the toe end.

If you want to change the lighting sensitivity of the PEDAL FX indicator, repeat step 4 while you adjust the THRESHOLD value with knob [4].

7. Press the [WRITE] button.

The screen will indicate "COMPLETED!"

- * When you operate the expression pedal, please be careful not to get your fingers pinched between the movable part and the panel. In places where small children are present, make sure that an adult provides supervision and guidance.

Connecting External Pedals

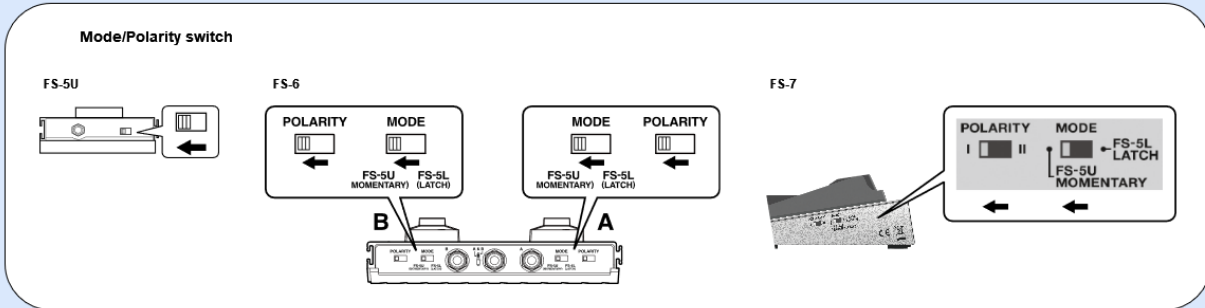
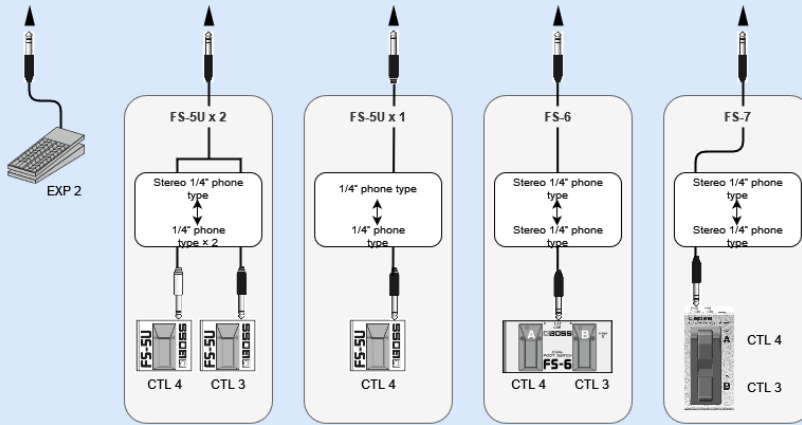

Looper

You can record a performance and play back the recorded section over and over (mono: up to 38 seconds, stereo: up to 19 seconds). You can also layer additional performances (overdubbing) with the recording as it plays back.

This lets you create real-time backing performances on the fly.

You must place the looper somewhere in the effect chain in order to use it.

Also, you need to assign the looper's record, play, and overdub functions to the switches you want. Here's an example of how you can use the [C1] switch on this unit or an external footswitch connected to CTL 3, 4/EXP jack on this unit to operate the looper.

Placing the looper in the effect chain

1. Select the memory with which you want to use the looper.
2. Follow the steps in "3.2. Effect Placement(P.26)" to place the looper in the effect chain.

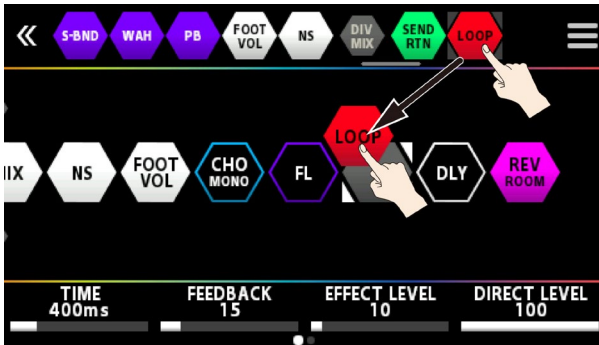

Assigning Looper Functions to Switches

1. Follow the steps in "8.1. Assigning a Function(P.49)" to display the CONTROL FUNCTION screen.
2. For "CTL 1," "CTL 3," and "CTL 4," set FUNCTION as follows.

CONTROL FUNCTION				
	BANK ▼	BANK ▲	CTL 1	CTL 2
FUNC	BANK ▼	BANK ▲	LOOP CTL	TUNER/MAN
MODE				
PREF	MEMORY	MEMORY	MEMORY	MEMORY
	1	2	3	4
FUNC	1	2	3	4
MODE				
PREF	MEMORY	MEMORY	MEMORY	MEMORY

CONTROL FUNCTION				
	EXP 1 SW		CTL 3	CTL 4
FUNC	OFF		LOOP STOP	LOOP CLEAR
MODE				
PREF	MEMORY		MEMORY	MEMORY
	EXP 1 PEDAL	EXP 2		CUR NUM
FUNC	FV/PEDAL FX	OFF		OFF
MODE				
PREF	MEMORY	MEMORY		MEMORY

Parameter	Value	Explanation
CTL 1	LOOPER CTL	Starts recording. Each time you press the switch, operation alternates between playback and overdubbing. Press twice to stop playback. Long-press to erase the recording.

Parameter	Value	Explanation
CTL 3	LOOPER STOP	Stops recording or playback.
CTL 4	LOOPER CLEAR	Clears the recording.

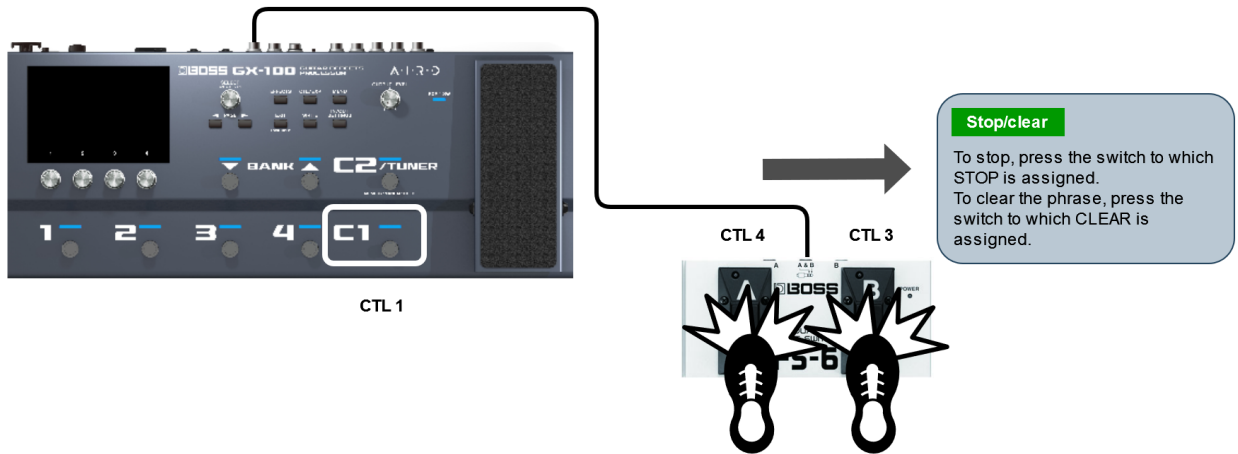
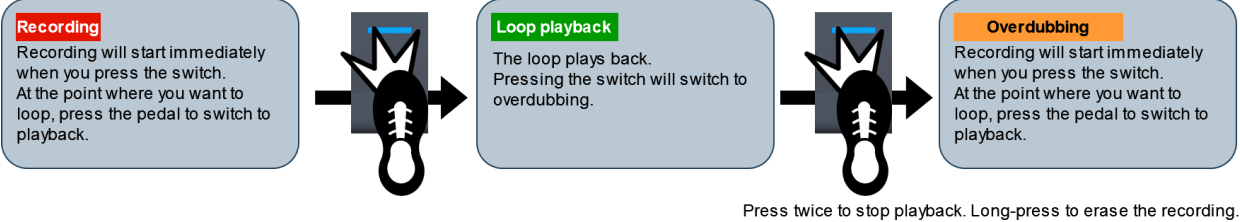

Loop Playback Level Setting

If you set the playback level at 100 (default value), the volume of the performance and that of the loop playback will be identical.

If you set the playback level to a value lower than 100, the volume of the playback will be lower than that of the performance. As a result, the sound of the performance won't get buried by the loop playback sound, even if you record a multiple number of times.

1. Following the steps in "3.1. Basic Procedure for Effect Editing(P.23)," touch the "LOOP" icon on the effect chain screen.

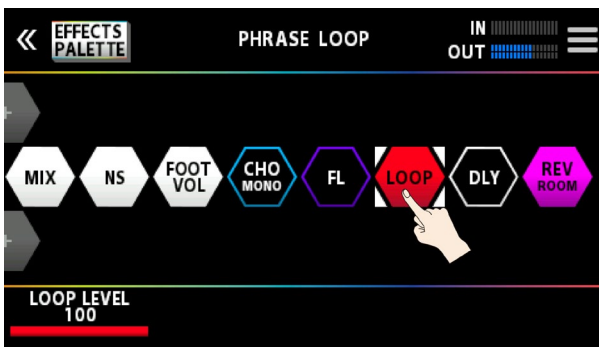

2. Turn knob [1] to specify the "PLAY LEVEL" value.

Switch Color

The switches light up in the following colors when you assign the looper function to a footswitch on this unit.

Color	Status
Red	Recording
Orange	Overdubbing
Green	Playback
Green (blink)	Stopped (phrase exists)
Blue	Stopped (no phrase)

Error Message List

Indication	Meaning
OUT OF RANGE! SET AGAIN.	Displays when the expression pedal is not correctly set during calibration.
ASSIGN SETTINGS IS FULL!	Displays when an assign shortcut cannot be made because all 20 assignments have been set and are on.
CHAIN IS FULL!	Displays when 15 effects have been placed in the chain. To add a new effect, delete an existing effect.
DSP RESOURCE IS FULL! DELETE OR OVERWRITE EXISTING FX.	Displays when the DSP resources are full. You must delete an effect from the chain in this case.
CAN NOT OVERWRITE!	Displays when overwriting is not possible due to a lack of DSP resources. You must delete another effect from the chain in this case.
THE NUMBER OF SAME FX IS LIMITED TO 9	You can only place the same effect up to nine times.
USB MIDI OFFLINE	There is a problem with the USB or MIDI cable connection. Check to make sure the cable has not been disconnected and that there is no short in the cable.

Main Specifications

Sampling Frequency	48 kHz
AD Conversion	24 bits + AF method * AF method (Adaptive Focus method) This is a proprietary method from Roland & BOSS that vastly improves the signal-to-noise (SN) ratio of the AD and DA converters.
DA Conversion	24 bits
Processing Effects	32-bit floating point 154 Types
Maximum Number of Effects	15+3 (DIVIDER/MIXER, SEND/RETURN, PHRASE LOOP) * depending on the circumstances
Memories	200 (USER) + 100 (PRESET)
Phrase Loop	38 sec. (MONO) 19 sec. (STEREO)
Tuner Internal Detection	+/-0.1 cent
Nominal Input Level	INPUT: -10 dBu RETURN: -10 dBu
Maximum Input Level	INPUT: +18 dBu RETURN1: +8 dBu
Input Impedance	INPUT: 1 M ohm RETURN: 1 M ohm
Nominal Output Level	OUTPUT (L/MONO, R): -10 dBu PHONES: -10 dBu SEND: -10 dBu
Output Impedance	OUTPUT (L/MONO, R): 1 k ohm PHONES: 44 ohms SEND: 1 k ohm
Recommended Load Impedance	OUTPUT (L/MONO, R): 10 k ohms or greater PHONES: 44 ohms or greater SEND: 10 k ohms or greater
Controls	BANK ▼ switch, BANK ▲ switch, CTL1 switch, CTL2/TUNER switch, 1--4 switches, POWER switch, EXP1 switch, GND LIFT switch, EFFECTS button, CTL/EXP button, MENU button, EXIT button, WRITE button, IN/OUT SETTINGS button, PAGE button, 1--4 knobs, SELECT knob, OUTPUT LEVEL knob, EXP1 pedal
Display	Color Graphic LCD (480 x 272 dots) Touch screen
Connectors	INPUT jack, OUTPUT (L/MONO, R) jacks, SEND jack, RETURN jack: 1/4-inch phone type PHONES jack: Stereo 1/4-inch phone type CTL3, 4/EXP2 jack, AMP CTL1, 2 jack: 1/4-inch TRS phone type MIDI (IN, OUT) connectors USB COMPUTER port: USB B type Bluetooth ADAPTOR connector: Dedicated connector DC IN jack
Power Supply	AC adaptor
Current Draw	1.2 A
Dimensions	460 (W) x 193 (D) x 73 (H) mm 18-1/8 (W) x 7-5/8 (D) x 2-7/8 (H) inches Maximum height: 460 (W) x 193 (D) x 94 (H) mm 18-1/8 (W) x 7-5/8 (D) x 3-3/4 (H) inches
Weight	3.5 kg 7 lbs 12 oz
Accessories	AC adaptor (PSB-1U + AC Cord Set) Owner's manual Leaflet "USING THE UNIT SAFELY"

Sampling Frequency	48 kHz
Options (sold separately)	Footswitch: FS-5U, FS-5L, FS-6, FS-7 Expression Pedal: EV-30, FV-500L, FV-500H, Roland EV-5 Bluetooth(R) Audio MIDI Dual Adaptor: BT-DUAL

- * 0 dBu = 0.775 Vrms
- * This document explains the specifications of the product at the time that the document was issued. For the latest information, refer to the Roland website.

GX-100

Reference Manual

01

© 2022 Roland Corporation