



---

---

# Contents

<b>Before you start</b> .....	<b>5</b>
How to read this manual .....	5
What's in the box.....	5
User guides .....	6
<b>Part names</b> .....	<b>7</b>
Top panel .....	7
Front panel .....	24
Rear panel.....	27
<b>PC/Mac setup</b> .....	<b>29</b>
Setting Utility .....	31
<b>Connections</b> .....	<b>36</b>
Connecting to the input terminals.....	36
Connecting to the output terminals .....	37
Step-by-step connections.....	38
<b>Serato DJ Pro</b> .....	<b>39</b>
Installing Serato DJ Pro .....	39
Basic operations for Serato DJ Pro.....	42
Playback.....	46
Loop .....	49
Performance Pads .....	51
Deck Pads.....	66
Dual Deck mode.....	70
Auto BPM Transition .....	71
Slip .....	72
Fader Start .....	73
Using effects .....	75

<b>rekordbox</b> .....	<b>76</b>
Installing rekordbox .....	77
Basic operations for rekordbox .....	80
Loop .....	85
Performance Pads .....	87
Deck Pads .....	100
Dual Deck mode .....	101
Auto BPM Transition .....	102
Slip .....	104
Fader Start .....	107
Beat FX .....	109
Recording .....	110
Changing the settings in rekordbox .....	111
<b>Audio output</b> .....	<b>115</b>
Outputting sound .....	115
Adjusting the sound .....	116
Setting the crossfader curve .....	116
<b>Monitoring sound</b> .....	<b>117</b>
Monitoring with headphones .....	117
Using a booth monitor .....	117
<b>Microphone</b> .....	<b>118</b>
Using a microphone .....	118
<b>AUX</b> .....	<b>119</b>
Using AUX .....	119
<b>Settings</b> .....	<b>120</b>
Changing the settings .....	120
Utility settings .....	121
<b>Using other types of DJ software</b> .....	<b>132</b>
<b>Specifications</b> .....	<b>133</b>

<b>Additional information .....</b>	<b>136</b>
Troubleshooting .....	136
Trademarks and registered trademarks .....	141
Software license notice .....	142
Cautions on copyrights.....	144



---

---

# Before you start

---

---

## How to read this manual

- Thank you for choosing this Pioneer DJ product.  
Be sure to read this manual, the Quick Start Guide and the Precautions for Use which are also included with this product. These documents include important information that you should understand before using the unit.
- In this manual the names of buttons, knobs and terminals that appear on the product, and the names of buttons, menus etc. in the software on your PC/Mac or mobile device, are indicated within square brackets ([ ]). (e.g. **[File]**, **[CUE]** button)
- Please note that the software screens and their specifications, as well as the external appearance and specifications of the hardware, are subject to change without notice.
- Please note that depending on the operating system version, web browser settings, etc. operation may differ from the ways described in this manual.
- Please note that the language on the screens of the software described in this manual may differ from the language on your screen.

---

---

## What's in the box

- AC adapter
- Power cord
- USB cable<sup>\*1</sup>
- Warranty (for some regions)<sup>\*2</sup>
- Quick Start Guide
- Precautions for Use
- Serato DJ Pro Pitch 'n Time DJ voucher<sup>\*3</sup>

\*1 One USB cable is included with the unit. To connect 2 devices to the unit, use an additional cable that conforms to USB 2.0 standards.

\*2 Only products in Europe.

Products in North America and Japan include warranty information in the Precautions for Use.

\*3 The voucher code needed to activate the function can't be reissued. Keep it in a safe place to be sure you don't lose it.

## User guides

### ❖ Serato DJ Pro software manual

Refer to the following site.

[serato.com/dj/pro/downloads](https://serato.com/dj/pro/downloads)

### ❖ rekordbox Introduction, Instruction Manual

Refer to the rekordbox Introduction to find out how to set up rekordbox, and see the Instruction Manual to find out how to use rekordbox.

Visit the URL below to find these user guides.

[rekordbox.com/manual](https://rekordbox.com/manual)

---

---

# Part names

---

---

## Top panel

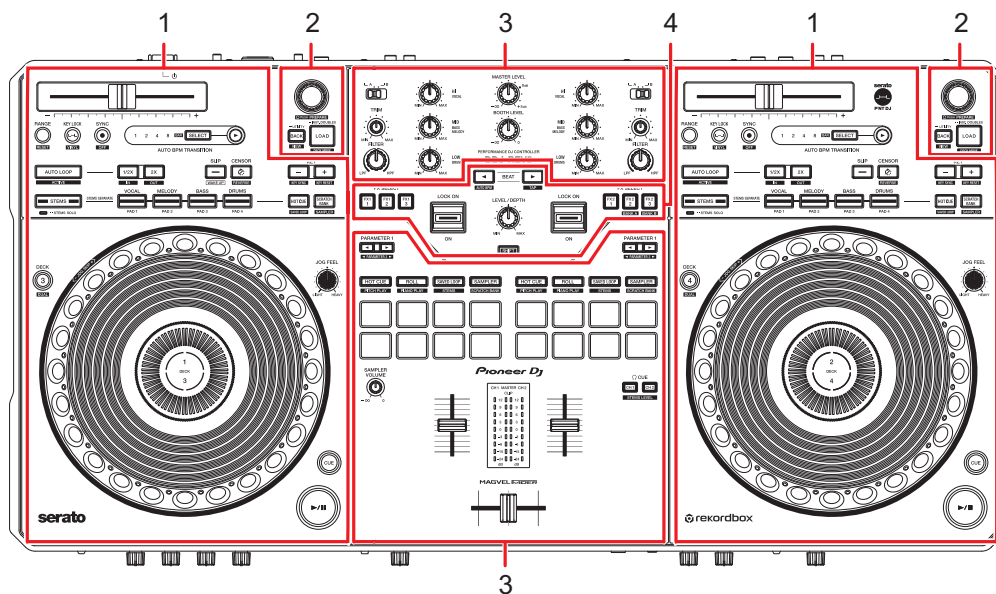

1. Deck section
2. Browse section
3. Mixer section
4. Effects section

## Deck section

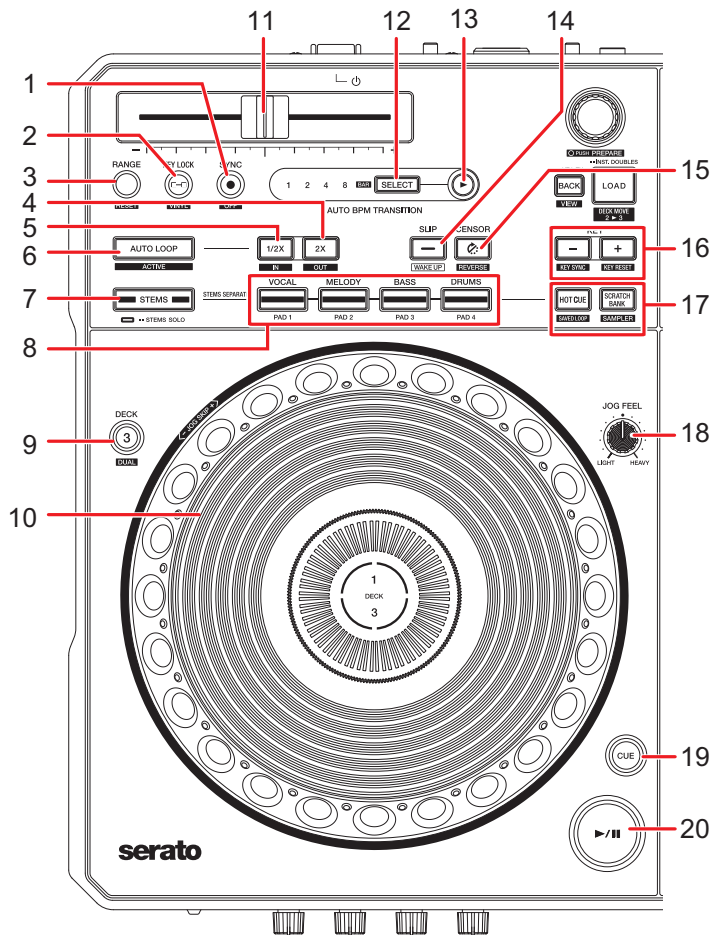

### ❖ When using Serato DJ Pro

#### 1. SYNC button

The BPM and beatgrid of the track playing on the deck whose button is pressed is synchronized to the track loaded on the other deck (page 48).

- Press while pressing the **[SHIFT]** button to turn Beat Sync off.

#### 2. KEY LOCK button

Turns Key Lock on and off (page 47).

- Press while pressing the **[SHIFT]** button to turn Vinyl mode on and off.

#### 3. RANGE button

Sets the variable range of the Tempo slider (page 46).

- Press while pressing the **[SHIFT]** button to reset to the track's original speed regardless of the Tempo slider's setting.

## 4. **2X button**

Doubles the length of a loop (page 49).

- Press while pressing the **[SHIFT]** button to set a loop-out point (page 49).
- Press while pressing the **[SHIFT]** button during loop playback to adjust a loop-out point (page 50).
- Press during Loop Roll playback to change the number of beats for the Loop Roll (page 53).

## 5. **1/2X button**

Halves the length of a loop (page 49).

- Press while pressing the **[SHIFT]** button to set a loop-in point (page 49).
- Press while pressing the **[SHIFT]** button during loop playback to adjust a loop-in point (page 50).
- Press during Loop Roll playback to change the number of beats for the Loop Roll (page 53).

## 6. **AUTO LOOP button**

Plays a loop of the specified number of beats or starts Auto Beat Loop (page 49).

- Press while pressing the **[SHIFT]** button to turn Loop Active on and off.
- You can choose whether the **[AUTO LOOP]** button starts a loop of the specified number of beats or starts Auto Beat Loop in **[LOOP options.]** in Setting Utility (page 34).

## 7. **STEMS button**

Turns Stems mode on.

- Press once to turn the Mute setting on.
- Press twice to turn the Solo setting on.

## 8. **Pad buttons**

In Stems mode, use as the **[VOCAL]**, **[MELODY]**, **[BASS]**, **[DRUMS]** buttons.

In Deck Pads mode, use as the **[PAD 1]**, **[PAD 2]**, **[PAD 3]**, **[PAD 4]** buttons.

— **[VOCAL/PAD 1]**: Press to turn mute on and off for the Vocal Stem when the Mute setting is turned on in Stems mode. Press to output only the Vocal Stem when the Solo setting is turned on. Press again to output all Stems.

Press while pressing the **[STEMS]** button to load the track from the other deck to the one you're pressing buttons on. If you do this during playback, the playback position will be matched. The deck you're pressing buttons on outputs only the Vocal Stem, and the Vocal Stem on the other deck is muted.

- **[MELODY/PAD 2]:** Press to turn mute on and off for the Melody Stem when the Mute setting is turned on in Stems mode. Press to output only the Melody Stem when the Solo setting is turned on. Press again to output all Stems.  
Press while pressing the **[STEMS]** button to load the track from the other deck to the one you're pressing buttons on. If you do this during playback, the playback position will be matched. The deck you're pressing buttons on outputs only the Melody Stem, and the Melody Stem on the other deck is muted.
- **[BASS/PAD 3]:** Press to turn mute on and off for the Bass Stem when the Mute setting is turned on in Stems mode. Press to output only the Bass Stem when the Solo setting is turned on. Press again to output all Stems.  
Press while pressing the **[STEMS]** button to load the track from the other deck to the one you're pressing buttons on. If you do this during playback, the playback position will be matched. The deck you're pressing buttons on outputs only the Bass Stem, and the Bass Stem on the other deck is muted.
- **[DRUMS/PAD 4]:** Press to turn mute on and off for the Drums Stem when the Mute setting is turned on in Stems mode. Press to output only the Drums Stem when the Solo setting is turned on. Press again to output all Stems.  
Press while pressing the **[STEMS]** button to load the track from the other deck to the one you're pressing buttons on. If you do this during playback, the playback position will be matched. The deck you're pressing buttons on outputs only the Drums Stem, and the Drums Stem on the other deck is muted.

## 9. **DECK button**

Selects the deck to use.

- Press while pressing the **[SHIFT]** button to turn Dual Deck mode on and off.

## 10. **Jog wheel**

Turn the jog wheel when Vinyl mode is on to scratch.

- Turn the outer section of the jog wheel, or turn the top of the jog wheel when Vinyl mode isn't turned on to adjust the playback speed (Pitch Bend).
- Turn the jog wheel while pressing the **[SHIFT]** button to cycle through tracks with extra speed according to the rotation direction.
- Do not place anything on it or apply strong force.

## 11. **Tempo slider**

Adjusts the playback speed of a track.

- To the **[+]** side: Increases the playback speed.
- To the **[-]** side: Decreases the playback speed.

## 12. **SELECT button** (page 71)

Press while pressing the [**SHIFT**] button to adjust the number of bars the Auto BPM Transition will occur over.

- Press a pad button ([**VOCAL/PAD 1**], [**MELODY/PAD 2**], [**BASS/PAD 3**], [**DRUMS/PAD 4**]) while pressing the [**SELECT**] button to turn mute on for the Stem assigned to the button you press when Auto BPM Transition starts.

## 13. **▶ (Auto BPM Transition Start) button**

Starts Auto BPM Transition (page 71).

## 14. **SLIP button**

Turns Slip mode on and off (page 72).

## 15. **CENSOR button**

Plays the loaded track in reverse (Slip Reverse) while you're pressing the button (page 46).

- Press while pressing the [**SHIFT**] button to play a track in reverse. Reverse playback continues even if you release the buttons. Press while pressing the [**SHIFT**] button again to return to normal playback.
- Maintaining reverse playback from one track to the next isn't possible.
- You may not be able to scratch if you start loop playback, etc. during reverse playback.

## 16. **KEY -, KEY + buttons**

Adjusts the key (page 48).

- Press the [**KEY -**] button while pressing the [**SHIFT**] button to match the key of the track on the deck with the key of the track loaded on the other deck (Key Sync).
- Press the [**KEY +**] button while pressing the [**SHIFT**] button to reset the key of the track on the deck to its original key (Key Reset).

## 17. **Deck Pads mode buttons**

Turns on the pad mode assigned to the pressed button (page 66).

## 18. **JOG FEEL knob**

Adjusts the 'weight' of the jog wheel.

- Turn clockwise to increase the weight and counterclockwise to decrease it.

## 19. **CUE button**

Sets, plays from, or calls up a cue point.

- Press during pause to set a cue point.
- Press during playback to return to a cue point and pause (Back Cue).

- Press and hold after playback point returns to a cue point to continue playback while pressing the button (Cue Point Sampler).
- Press while pressing the [**SHIFT**] button to return playback point to the beginning of a track.

## 20. ▶/|| button

Plays or pauses a track.

- Press while pressing the [**SHIFT**] button to return to a temporary cue point and continue playback (Stutter).

## ❖ When using rekordbox

### 1. SYNC button

The BPM and beatgrid of the track on the deck whose button is pressed is synchronized to the track loaded on the master deck (page 101).

- Press while pressing the [**SHIFT**] button to set the deck as a master deck.
- Press during Beat Sync to turn it off.

### 2. KEY LOCK button

Resets the key of a track playing to its original key.

- Press while pressing the [**SHIFT**] button to turn Vinyl mode on and off.

### 3. RANGE button

Sets the variable range of the Tempo slider.

### 4. 2X button

Doubles the length of the loop (page 85).

- Press while pressing the [**SHIFT**] button to set a loop-out point (page 85).
- Press while pressing the [**SHIFT**] button during loop playback to adjust a loop-out point (page 86).

### 5. 1/2X button

Halves the length of the loop (page 85).

- Press while pressing the [**SHIFT**] button to set a loop-in point (page 85).
- Press while pressing the [**SHIFT**] button during loop playback to adjust a loop-in point (page 86).

### 6. AUTO LOOP button

Plays a loop (page 85).

- Press while pressing the [**SHIFT**] button to turn Loop Active on and off.
- You can choose the function applied when the [**AUTO LOOP**] button is pressed in [**AUTO BEAT LOOP**] under [**Preferences**] on the rekordbox screen (page 111).



## 7. **STEMS button**

Turns Active Part mode on.

- Press once to turn the Mute setting on.
- Press twice to turn the Solo setting on.

## 8. **Pad buttons** (page 100)

In Active Part mode, use the buttons to control the Vocal, INST, or Drums part.

In Deck Pads mode, use as the **[PAD 1]**, **[PAD 2]**, **[PAD 3]**, **[PAD 4]** buttons.

- **[VOCAL/PAD 1]**: Press to turn mute on and off for the Vocal part when the Mute setting is turned on in Active Part mode. Press to output only the Vocal part when the Solo setting is turned on. Press again to output all parts.

Press while pressing the **[STEMS]** button to load the track from the other deck to the one you're pressing buttons on. If you do this during playback, the playback position will be matched. The deck you're pressing buttons on outputs only the Vocal part, and the Vocal part on the other deck is muted.

- **[MELODY/PAD 2], [BASS/PAD 3]**: Press to turn mute on and off for the INST part when the Mute setting is turned on in Active Part mode. Press to output only the INST part when the Solo setting is turned on. Press again to output all parts.

Press while pressing the **[STEMS]** button to load the track from the other deck to the one you're pressing buttons on. If you do this during playback, the playback position will be matched. The deck you're pressing buttons on outputs only the INST part, and the INST part on the other deck is muted.

- **[DRUMS/PAD 4]**: Press to turn mute on and off for the Drums part when the Mute setting is turned on in Active Part mode. Press to output only the Drums part when the Solo setting is turned on. Press again to output all parts.

Press while pressing the **[STEMS]** button to load the track from the other deck to the one you're pressing buttons on. If you do this during playback, the playback position will be matched. The deck you're pressing buttons on outputs only the Drums part, and the Drums part on the other deck is muted.

## 9. **DECK button**

Selects the deck to use.

- Press while pressing the **[SHIFT]** button to turn Dual Deck mode on and off.

## 10. **Jog wheel**

Turn the jog wheel when Vinyl mode is on to scratch.

- Turn the outer section of the jog wheel, or turn the top of the jog wheel when Vinyl mode isn't turned on to adjust the playback speed (Pitch Bend).
- Turn the jog wheel while pressing the **[SHIFT]** button to cycle through tracks with extra speed according to the rotation direction.

- Do not place anything on it or apply strong force.

## 11. **Tempo slider**

Adjusts the playback speed of a track.

- To the **[+]** side: Increases the playback speed.
- To the **[-]** side: Decreases the playback speed.

## 12. **SELECT button** (page 102)

Press while pressing the **[SHIFT]** button to adjust the number of bars the Auto BPM Transition will occur over.

- Press a pad button (**[VOCAL/PAD 1]**, **[MELODY/PAD 2]**, **[BASS/PAD 3]**, **[DRUMS/PAD 4]**) while pressing the **[SELECT]** button to turn mute on for the part assigned to the button you press when Auto BPM Transition starts.

## 13. **▶ (Auto BPM Transition Start) button**

Starts Auto BPM Transition (page 102).

## 14. **SLIP button**

Turns Slip mode on and off (page 104).

## 15. **CENSOR button**

Plays a track in reverse while you're pressing the button. Normal playback continues in the background during reverse playback, but you can't hear this. If you release the button, normal playback starts from the exact point the track would have reached by then.

- Press while pressing the **[SHIFT]** button to play a track in reverse. Reverse playback continues even if you release the buttons. Press while pressing the **[SHIFT]** button again to return to normal playback.

## 16. **KEY -, KEY + buttons**

Adjusts the key.

- Press the **[KEY -]** button to lower the key of the track playing on the deck by a semitone.
- Press the **[KEY +]** button to raise the key of the track playing on the deck by a semitone.
- Press the **[KEY -]** button while pressing the **[SHIFT]** button to match the key of the track on the deck with the key of the track loaded on the other deck (Key Sync).
- Press the **[KEY +]** button while pressing the **[SHIFT]** button to reset the key of the track on the deck to its original key (Key Reset).

## 17. **Deck Pads mode buttons**

Turns on the pad mode assigned to the pressed button (page 100).

## 18. **JOG FEEL knob**

Adjusts the 'weight' of the jog wheel.

- Turn clockwise to increase the weight and counterclockwise to decrease it.

## 19. **CUE button**

Sets, plays from, or calls up a cue point.

- Press during pause to set a cue point.
- Press during playback to return to a cue point and pause (Back Cue).
- Press and hold after playback point returns to a cue point to continue playback while pressing the button (Cue Point Sampler).
- Press while pressing the [**SHIFT**] button to return playback point to the beginning of a track.

## 20. **▶/|| button**

Plays or pauses a track.

## Browse section

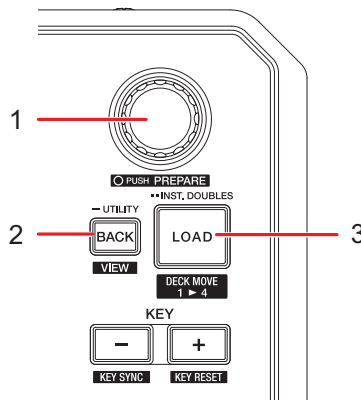

### ❖ When using Serato DJ Pro

#### 1. Rotary selector

Moves the cursor up and down in the track list or on the crates list of the Serato DJ Pro screen.

- Press when the cursor is in the track list or on the crates list to move the cursor between the track list and crates list.
- Press when the cursor is on the **[Files]** panel to move the cursor the next level down.
- Press when the cursor is on the **[Browse]** panel to move the cursor to the next category.
- Press while pressing the **[SHIFT]** button to load a track to the **[Prepare]** panel on the Serato DJ Pro screen.

#### 2. BACK button

Moves the cursor between the track list and the crates list of the Serato DJ Pro screen.

- Press when an item selected on the crates list has a subcrate to open or close the crate.
- Press when the cursor is on the **[Files]** panel to move the cursor the next level up.
- Press when the cursor is on the **[Browse]** panel to move the cursor to the previous category.
- Press while pressing the **[SHIFT]** button to switch the layout of the Serato DJ Pro screen.

#### 3. LOAD button

Loads the selected track to the deck.

- Press twice to load the track loaded on the other deck to the deck whose button is pressed (the playback position will be the same).
- Press the [**LOAD**] button on the left deck while pressing the [**SHIFT**] button to move a track from deck 2 to deck 3.
- Press the [**LOAD**] button on the right deck while pressing the [**SHIFT**] button to move a track from deck 1 to deck 4.

## ❖ When using rekordbox

### 1. Rotary selector

Moves the cursor up and down on the rekordbox screen.

- Press to move the cursor between the tree view and track list on the rekordbox screen.
- Press when the playlist palette is displayed to move the cursor between the tree view, track list, and playlist. For details on the tree view, track list, and playlist palette, see the rekordbox Instruction Manual (page 6).
- Turn while pressing the [**SHIFT**] button to enlarge or reduce the enlarged waveform on the rekordbox screen.
- Press while pressing the [**SHIFT**] button to add a track to the tag list in rekordbox.

### 2. BACK button

Moves the cursor between the tree view and track list on the rekordbox screen.

- Press when the playlist palette is displayed to move the cursor between the tree view, track list, and playlist. For details on the tree view, track list, and playlist palette, see the rekordbox Instruction Manual (page 6).
- Press while pressing the [**SHIFT**] button to switch the layout of the rekordbox screen.

### 3. LOAD button

Loads the selected track to the deck.

- Press twice to load the track loaded on the other deck to the deck whose button is pressed (the playback position will be the same).
- Press the [**LOAD**] button on the left deck while pressing the [**SHIFT**] button to move a track from deck 2 or 4 to deck 3.
- Press the [**LOAD**] button on the right deck while pressing the [**SHIFT**] button to move a track from deck 1 or 3 to deck 4.

## Mixer section

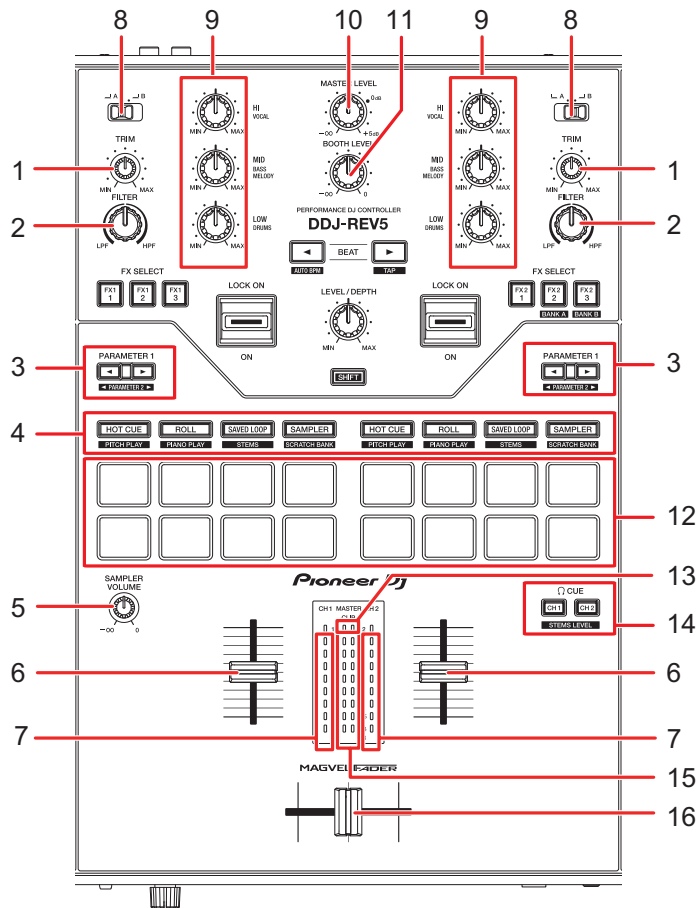

### ❖ When using Serato DJ Pro

1. **TRIM knob**  
Adjusts the volume for the channel input sound.
2. **FILTER knob**  
Adjusts a filter.
3. **PARAMETER 1 ◀, ▶ buttons**  
Sets the parameters.
4. **Pad mode buttons**  
Turns on the pad mode assigned to the pressed button (page 51).
5. **SAMPLER VOLUME knob**  
Adjusts the sampler volume.

## 6. **Channel fader**

Adjusts the volume for the channel output sound. Moving it up increases the volume, and down decreases the volume.

## 7. **Channel level indicator**

Displays the volume level before the sound passes through the channel fader.

## 8. **Input selector switch**

Selects an input sound source.

—  **A**: Selects a PC/Mac connected to the **[USB A]** terminal.

—  **B**: Selects a PC/Mac connected to the **[USB B]** terminal.

## 9. **HI, MID, LOW knobs**

Adjusts the volume of each frequency band in EQ mode.

Adjusts the volume of each Stem in Stems Level mode.

— **[HI]**: Adjusts the volume of the Vocal Stem.

— **[MID]**: Adjusts the volume of the Melody and Bass Stems.

— **[LOW]**: Adjusts the volume of the Drums Stem.

## 10. **MASTER LEVEL knob**

Adjusts the volume for the master sound output to the **[MASTER 1]** or **[MASTER 2]** terminals.

## 11. **BOOTH LEVEL knob**

Adjusts the volume for the sound output to a booth monitor.

## 12. **Performance Pads** (page 51)

## 13. **CLIP indicator**

Blinks when excessive volume is output from the **[MASTER 1]** or **[MASTER 2]** terminals.

## 14. **CUE button**

Selects the sound output to the PHONES terminals in EQ mode.

— **[CH 1]**: Outputs the sound of CH 1 and/or CH 3.

— **[CH 2]**: Outputs the sound of CH 2 and/or CH 4.

- Press while pressing the **[SHIFT]** button to switch between EQ mode and Stems Level mode.

## 15. **Master level indicator**

Displays the volume level of the master sound output to the **[MASTER 1]** and **[MASTER 2]** terminals.

## 16. **Crossfader**

Adjusts the volume balance between the channel output sounds according to the crossfader curve specified with the **[CURVE]** knob (page 25). Moving it to the Deck 1 (left) side outputs the sound of Deck 1, and to the Deck 2 (right) side outputs the sound of Deck 2.

## ❖ **When using rekordbox**

### 1. **TRIM knob**

Adjusts the volume for the channel input sound.

### 2. **FILTER knob**

Adjusts a filter or an effect.

### 3. **PARAMETER 1 ◀, ▶ buttons**

Sets the parameters.

### 4. **Pad mode buttons**

Turns on the pad mode assigned to the pressed button (page 87).

### 5. **SAMPLER VOLUME knob**

Adjusts the sampler volume.

### 6. **Channel fader**

Adjusts the volume for the channel output sound. Moving it up increases the volume, and down decreases the volume.

### 7. **Channel level indicator**

Displays the volume level before the sound passes through the channel fader.

### 8. **Input selector switch**

Selects an input sound source.

—  **A**: Selects a PC/Mac connected to the **[USB A]** terminal.

—  **B**: Selects a PC/Mac connected to the **[USB B]** terminal.

### 9. **HI, MID, LOW knobs**

Adjusts the volume of each frequency band in EQ mode.

Adjusts the volume of each part in Part ISO mode.

— **[HI]**: Adjusts the volume of the Vocal part.

— **[MID]**: Adjusts the volume of the INST part.

— **[LOW]**: Adjusts the volume of the Drums part.



## 10. **MASTER LEVEL knob**

Adjusts the volume for the master sound output to the **[MASTER 1]** or **[MASTER 2]** terminals.

## 11. **BOOTH LEVEL knob**

Adjusts the volume for the sound output to a booth monitor.

## 12. **Performance Pads** (page 87)

## 13. **CLIP indicator**

Blinks when excessive volume is output from the **[MASTER 1]** or **[MASTER 2]** terminals.

## 14. **CUE button**

Adjusts the volume for the sound output from the PHONES terminals in EQ mode.

— **[CH 1]**: Outputs the sound of CH 1 and/or CH 3.

— **[CH 2]**: Outputs the sound of CH 2 and/or CH 4.

- Press while pressing the **[SHIFT]** button to switch between EQ mode and Part ISO mode.

## 15. **Master level indicator**

Displays the volume level of the master sound output to the **[MASTER 1]** and **[MASTER 2]** terminals.

## 16. **Crossfader**

Adjusts the volume balance between the channel output sounds according to the crossfader curve specified with the **[CURVE]** knob (page 25). Moving it to the Deck 1 (left) side outputs the sound of Deck 1, and to the Deck 2 (right) side outputs the sound of Deck 2.

## Effects section

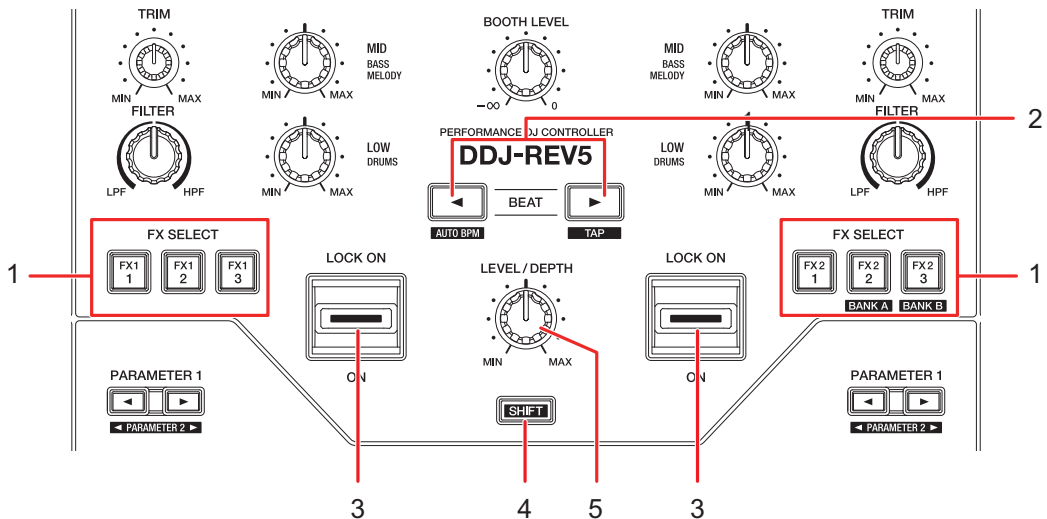

### ❖ When using Serato DJ Pro

#### 1. FX SELECT buttons

Select an effect.

- Press the [FX2-2] button while pressing the [SHIFT] button to select Bank A, and press the [FX2-3] button while pressing the [SHIFT] button to select Bank B.
- Turn the rotary selector while pressing the [FX SELECT] button to select an effect type.
- Press multiple [FX SELECT] buttons at the same time to use multiple effects.

#### 2. BEAT ◀, ▶ button

Sets the number of beats for an effect.

- Press the [◀] button while pressing the [SHIFT] button to automatically set BPM (Auto BPM).
- Press the [▶] button while pressing the [SHIFT] button to manually set BPM according to the average time between taps (Tap mode).

#### 3. Effect lever

Applies an effect.

- [LOCK ON]: Continues applying an effect even after you release the effect lever leaving it in the [LOCK ON] position. Return the effect lever to the center position to turn the effect off.

- **[ON]**: Applies an effect while you hold the effect lever in the **[ON]** position. Release the lever to return it to the center position and turn the effect off.

#### 4. **SHIFT button**

#### 5. **LEVEL/DEPTH knob**

Adjusts the quantitative parameters for effects.

### ❖ **When using rekordbox**

#### 1. **FX SELECT buttons**

Select an effect.

- Press the **[FX2-2]** button while pressing the **[SHIFT]** button to select Bank A, and press the **[FX2-3]** button while pressing the **[SHIFT]** button to select Bank B.
- Press multiple **[FX SELECT]** buttons at the same time to use multiple effects.

#### 2. **BEAT ◀, ▶ button**

Sets the number of beats for an effect.

Decreases the number of beats for synchronizing the Beat FX sound each time the **[◀]** button is pressed.

Increases the number of beats for synchronizing the Beat FX sound each time the **[▶]** button is pressed.

- Press the **[◀]** button while pressing the **[SHIFT]** button to apply BPM Auto mode to Beat FX. Track's BPM value will be the reference for the BEAT FX tempo.
- Press the **[▶]** button while pressing the **[SHIFT]** button to manually set BPM according to the average time between taps (Tap mode).

#### 3. **Effect lever**

Applies an effect.

- **[LOCK ON]**: Continues applying an effect even after you release the effect lever leaving it in the **[LOCK ON]** position. Return the effect lever to the center position to turn the effect off.
- **[ON]**: Applies an effect while you hold the effect lever in the **[ON]** position. Release the lever to return it to the center position and turn the effect off.

#### 4. **SHIFT button**

#### 5. **LEVEL/DEPTH knob**

Adjusts the quantitative parameters for effects.

## Front panel

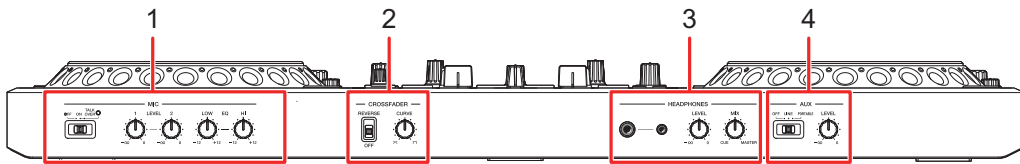

1. **MIC section**
2. **Crossfader section**
3. **Headphones section**
4. **AUX section**

---

## MIC section

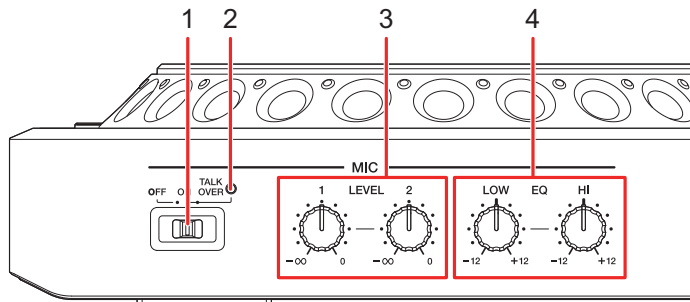

### 1. **OFF, ON, TALKOVER selector switch**

Sets the microphone sound output.

- **[OFF]**: Turns the microphone off.
- **[ON]**: Turns the microphone on.
- **[TALKOVER]**: Turns microphone talkover on. When sound of -10 dB or more is input to the microphone, the volume other than the microphone channel is attenuated by -18 dB.

- You can change the attenuation level of talkover mode in **[MIC TALKOVER LEVEL]** in Utility mode (page 123).

### 2. **MIC indicator**

Indicates the status of the **[OFF, ON, TALKOVER]** selector switch as follows.

- Off: Set to **[OFF]**.
- Lights up: Set to **[ON]**.
- Blinks: Set to **[TALKOVER]**.

### 3. LEVEL 1, 2 knobs

Adjusts the volume of sound input from the **[MIC 1]** or **[MIC 2]** terminals.

### 4. EQ HI, EQ LOW knobs

Adjusts the volume of sound input from the **[MIC 1]** or **[MIC 2]** terminals.  
Each knob adjusts in the following range.

- **[HI]**: -12 dB to +12 dB (10 kHz)
- **[LOW]**: -12 dB to +12 dB (100 kHz)

## Crossfader section

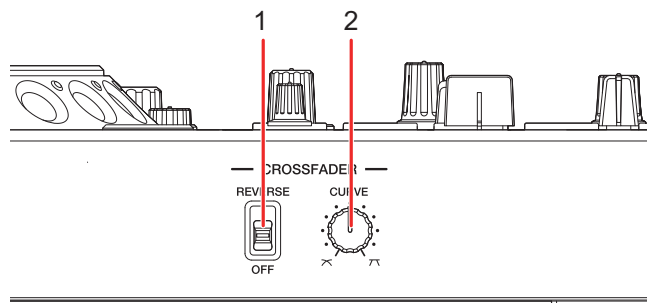



### 1. REVERSE switch

Turns the crossfader reverse function on and off.

### 2. CURVE knob

Sets the crossfader curve.

-  : Gradually raises the volume of the sound assigned to the other side as the crossfader is moved from one side (CH 1 or CH 2 side) to the other, and decreases the volume of the sound on the side it's moving away from.
-  : Steeply raises the volume of the sound assigned to the other side as the crossfader is moved from one side (CH 1 or CH 2 side) to the other.

## Headphones section

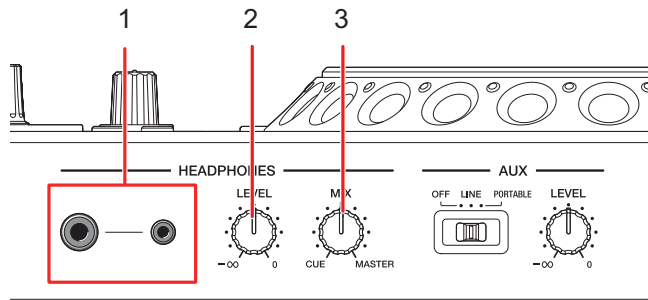

1. **PHONES terminals** (stereo phone plugs Ø 6.3 mm, Ø 3.5 mm)  
Connect headphones to one of the terminals (1/4" stereo jack or 3.5 mm stereo mini-jack). If you use both terminals at the same time, when you insert or remove headphones into/from a terminal, the volume for headphones connected to the other terminal may suddenly increase or decrease.
2. **LEVEL knob**  
Adjusts the volume for the sound output from the PHONES terminals.
3. **MIX knob**  
Adjusts the volume balance between the master sound and the channel selected with the [🎧 **CUE**] button.
  - Set the knob to [**CUE**] to monitor only the channel sound, and to [**MASTER**] to monitor only the master sound.

---

## AUX section

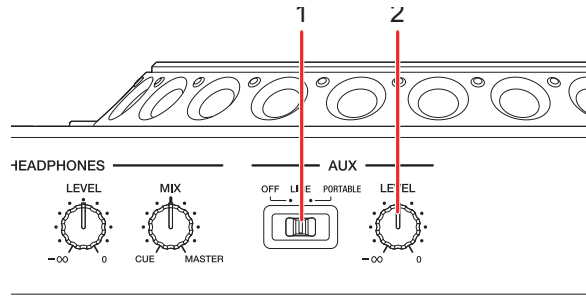

### 1. AUX (OFF, LINE, PORTABLE) switch

- **[OFF]**: Mutes the input sound (AUX isn't used).
- **[LINE]**: Sound is input from devices other than a mobile device.
- **[PORTABLE]**: Sound is input from a mobile device.

### 2. LEVEL knob

Adjusts the volume for the input sound of the AUX channel.

---

## Rear panel

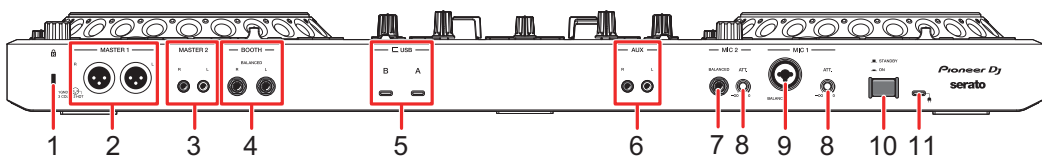

### 1. Kensington security slot

Connect a cable lock.

### 2. MASTER 1 terminals (balanced XLR)

Connect to analog input terminals on a power amplifier, etc.

- Use the terminals for balanced output only. Connecting the terminals to unbalanced inputs (RCA, etc.) with an XLR-RCA conversion cable (conversion adapter), etc. results in unwanted noises and/or poor sound quality.
- Do not connect a power cord from another product to the terminals.

- Do not connect to a terminal that can supply phantom power.
3. **MASTER 2 terminals (RCA)**  
Connect to analog input terminals on a power amplifier, etc.
    - Use the [**MASTER 2**] terminals for unbalanced input (RCA, etc.).
  4. **BOOTH terminals (1/4"/6.35 mm, TRS)** (page 117)  
Connect a booth monitor.
    - Use the terminals for balanced output only. Connecting the terminals to unbalanced inputs results in unwanted noises and/or poor sound quality.
  5. **USB ports** (page 36)  
Connect a PC/Mac.
  6. **AUX terminals** (pages 36, 119)  
Connect a line-level output device.
  7. **MIC 2 terminal (1/4"/6.35 mm, TRS)** (pages 36, 118)
  8. **ATT. knob** (page 118)  
Adjusts the sound level input to the [**MIC 1**] and [**MIC 2**] terminals.
    - Microphone gain varies depending on the microphone you use. Adjust the sound level according to your microphone before using it.  
To adjust the microphone volume during a performance, use the [**LEVEL 1**] or [**LEVEL 2**] knob in the MIC section on the front panel (page 24).
  9. **MIC 1 terminal (XLR or 1/4"/6.35 mm, TRS)** (pages 36, 118)
  10. **⏻ button**  
Turns the unit on (⏻) and off (■).
  11. **DC IN terminal**  
Connect to a power outlet with the supplied AC adapter and power cord (page 36).



---

---

# PC/Mac setup

To input or output your PC/Mac's audio to/from the unit, install the dedicated audio driver software and/or Setting Utility on your computer.

If you install the audio driver software to your PC (Windows), Setting Utility will also be installed with the driver software.

If you use a Mac, install Setting Utility only.

- For information on the latest system requirements, compatibility, and supported operating systems, visit the URL below.

[pioneerdj.com/support/](http://pioneerdj.com/support/)

- Operation isn't guaranteed on all PC/Mac models, even if the system requirements are met.
- Operation isn't guaranteed when multiple units are connected to a PC/Mac.
- If a PC (Windows) without the dedicated audio driver software installed is connected to the unit, errors may occur on the PC.
- Malfunctions may occur due to incompatibility with other software installed on a PC/Mac.
- The [KEY -] and [KEY +] buttons blink when a PC/Mac without the dedicated audio driver software and/or Setting Utility is connected to the unit.

---

## Installation

### ❖ Notes on installation

- Turn the unit off and disconnect the USB cable connected to the unit and the PC/Mac before installation.
- Close all applications running on the PC (Windows) before installation.
- You'll need admin rights to install the dedicated audio driver software to your PC (Windows).
- Read the License Agreement terms carefully before installation.
- If you quit the installation halfway through, perform the installation procedure from the beginning again.
- After the installation is complete, connect the PC/Mac to the unit.
- Operation isn't guaranteed on all PC/Mac models.

---

## Downloading the dedicated software

**1 Visit the URL below.**

[pioneerdj.com/support/](http://pioneerdj.com/support/)

**2 Click [Software & firmware updates].**

**3 Click [DDJ-REV5] under [DJ CONTROLLER].**

**4 Click [Drivers].**

**5 Click [Download link] and save the file.**

- Download the audio driver software dedicated to your PC/Mac.

---

## Installing the dedicated software

**1 Unzip the downloaded dedicated software.**

**2 Double-click the installation file.**

- Double-click “DDJ-REV5\_#.###.exe” if you’re using a PC (Windows), or “DDJ-REV5\_M\_#.###.dmg” → “DDJ-REV5SettingUtility.pkg” if you’re using a Mac (# indicates the version number of the software).

**3 Read the Software end user license agreement carefully. If you agree to the terms, mark the [Agree] check box and click [OK].**

- If you don’t agree to the license agreement terms, click [Disagree] (for Mac)/[Cancel] (for Windows) to cancel the installation.

**4 Follow the on-screen instructions to complete the installation.**

---

## Setting Utility

Once you've installed the dedicated software on your PC/Mac, you can use the Setting Utility to check and set connections between the unit and a PC/Mac.

---

### Launching Setting Utility

#### ❖ For Mac

- 1 Open the [Applications] folder in Finder.
- 2 Click [Pioneer] → [DDJ-REV5] → [DDJ-REV5 Setting Utility].

#### ❖ For Windows 11

- 1 Open the Start menu and click [All Apps] → [Pioneer] → [DDJ-REV5 Setting Utility].

#### ❖ For Windows 10

- 1 Open the Start menu and click [Pioneer] → [DDJ-REV5 Setting Utility].

---

## Adjusting the buffer size (for Windows ASIO)

- Close any running applications (DJ applications, etc.) which use the unit as the default audio device before adjusting the buffer size.

**1 Click the [ASIO] tab.**

**2 Adjust the buffer size with the slider.**



- Breaks in sound are less likely to occur if you set a large buffer size, but this increases lag time due to the latency of audio data transmission.

## Changing the settings

- 1 Click the [PREFERENCES] tab.
- 2 Change the settings.

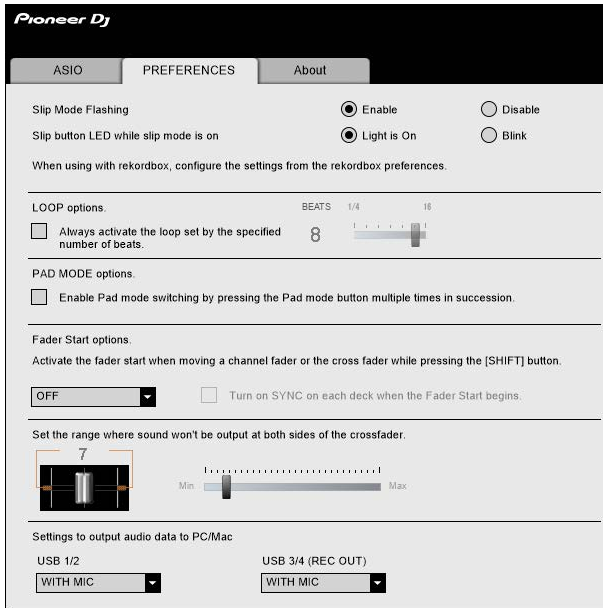

Setting item	Description
<b>Slip Mode Flashing</b>	<p>Sets whether the LEDs of buttons and knobs used for Slip operations blink (enable/disable Slip Mode Flashing) when Slip mode is turned on in Serato DJ Pro.</p> <ul style="list-style-type: none"> <li>• For rekordbox, set from [Preferences] on the rekordbox screen (page 111).</li> </ul>
<b>Slip button LED while slip mode is on</b>	<p>Sets whether to light up or blink the [SLIP] button when Slip mode is turned on in Serato DJ Pro.</p> <ul style="list-style-type: none"> <li>— [Light is on]: Lights up the [SLIP] button when Slip mode is turned on, and blinks it during slip playback.</li> <li>— [Blink]: Blinks the [SLIP] button when Slip mode is turned on.</li> </ul> <ul style="list-style-type: none"> <li>• For rekordbox, set from [Preferences] on the rekordbox screen (page 111).</li> </ul>

Setting item	Description
<b>LOOP options.</b>	<p>When using the unit with Serato DJ Pro, mark the check box to activate the loop length set by the slider.</p> <p>Clear the check box to set the <b>[AUTO LOOP]</b> button on the unit to work as the Auto Beat Loop button.</p> <ul style="list-style-type: none"> <li>For rekordbox, set this function from <b>[Preferences]</b> on the rekordbox screen (page 111).</li> </ul>
<b>PAD MODE options.</b>	<p>Mark the check box to enable Pad mode switching by pressing a Pad mode button a few times in succession.</p> <ul style="list-style-type: none"> <li>When 2 computers (PC/Mac) are connected to the unit and the input selector switches for CH 1 and CH 2 are set to the different computers, this setting will be valid when it's enabled on each PC/Mac.</li> </ul>
<b>Fader Start options.</b>	<p>To enable the Fader Start function, select <b>[CUE]</b> or <b>[HOT CUE]</b> from the pull-down list.</p> <p>To enable Sync function for the Fader Start function, mark the check box.</p> <ul style="list-style-type: none"> <li>The check box is valid when using Serato DJ Pro.</li> <li>Only Hot Cue A works when <b>[HOT CUE]</b> is selected.</li> <li>The <b>[HOT CUE]</b> setting doesn't work properly when the <b>[During Pause, GATE playback is applied.]</b> check box is marked in <b>[Preferences]</b> → <b>[Deck]</b> → <b>[Hot Cue]</b> in rekordbox.</li> </ul> <p> Read more: Fader Start (page 73), Fader Start (page 107)</p>
<b>Set the range where sound won't be output at both sides of the crossfader.</b>	<p>Use the slider to set the range where sound won't be output at both ends of the crossfader.</p>
<b>Settings to output audio data to PC/Mac</b>	<p>Sets whether or not to output the microphone sound to the recording channel (<b>[WITH MIC]</b>/<b>[WITHOUT MIC]</b>).</p>

## Checking the firmware and dedicated software versions

### 1 Click the [About] tab.

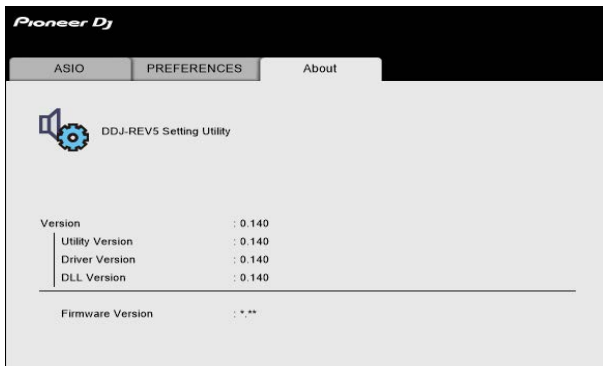

---

---

# Connections

Turn the unit off and disconnect the power cord before connecting other units.

Connect the power cord after all the connections are complete.

- Use the supplied AC adapter and power cord.
- Take care so that no load is put on the cable and connector of the AC adapter, for example, by placing the unit and the AC adapter at the same level.
- Read the instruction manuals for the devices you are going to connect with the unit.
- Connect the unit directly to your PC/Mac with the supplied USB cable or a USB cable that conforms to USB 2.0 standards.
  - To connect to a USB Type-C port: Use the USB cable supplied with the unit or a USB 2.0 compliant cable
  - To connect to a USB Type-A port: Use a standard USB cable of 3 m or less in length.

---

---

## Connecting to the input terminals

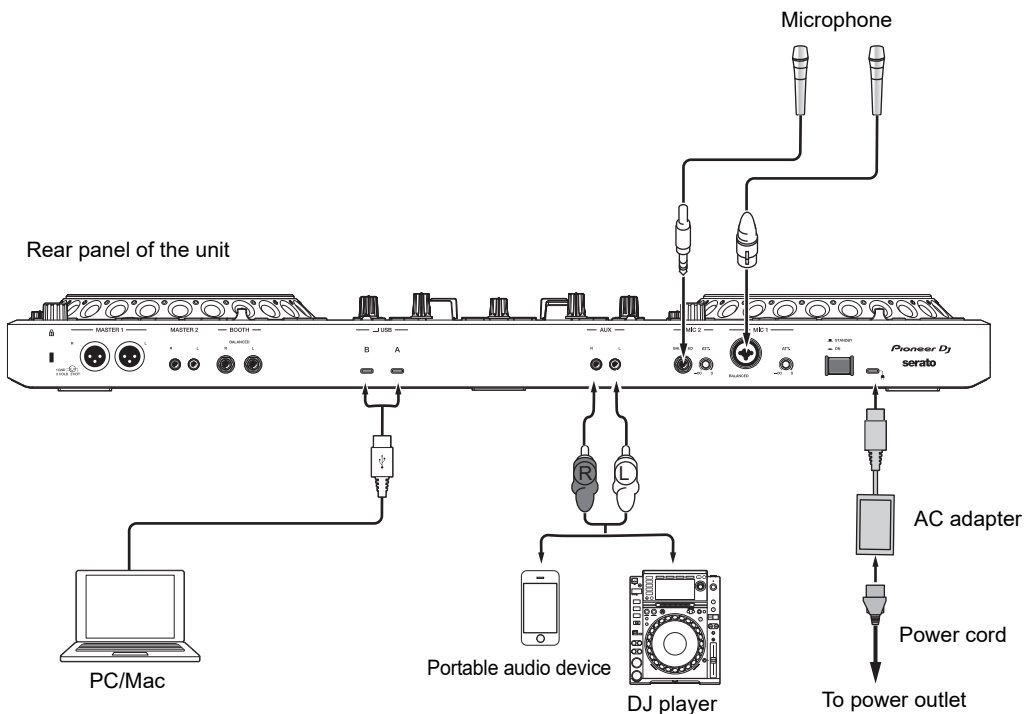



## Connecting to the output terminals

### ❖ Front panel

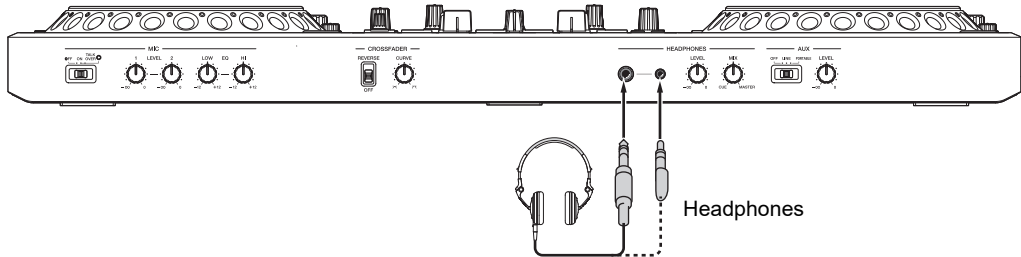

- Connect headphones to one of the terminals (1/4" stereo jack or 3.5 mm stereo mini-jack). If you use both terminals at the same time, when you insert or remove headphones into/from a terminal, the volume for headphones connected to the other terminal may suddenly increase or decrease.

### ❖ Rear panel

Power amplifier,  
powered speakers, etc.

Power amplifier (for booth monitor),  
powered speakers, etc.

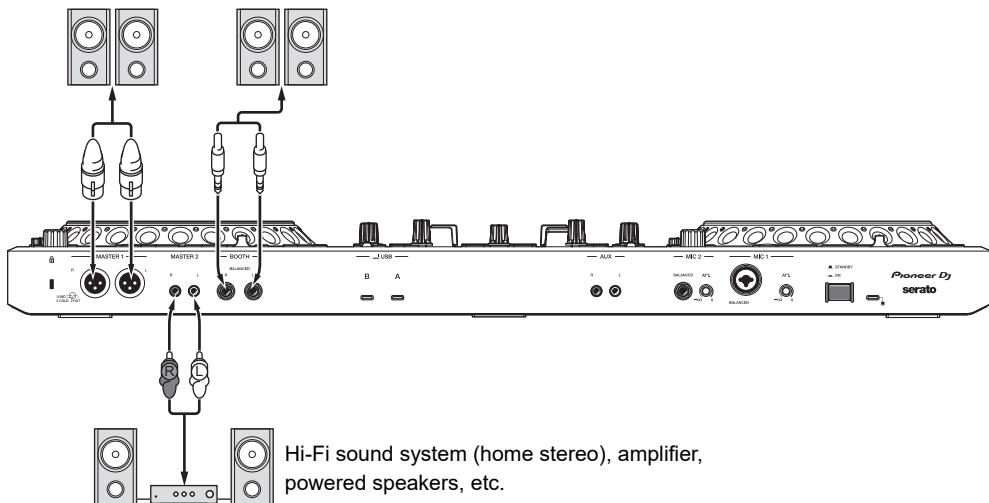

- Use the **[MASTER 1]** terminals for balanced output only. Connecting the terminals to unbalanced inputs (RCA, etc.) with an XLR-RCA conversion cable (conversion adapter), etc. results in unwanted noises and/or poor sound quality.
- Use the **[MASTER 2]** terminals for unbalanced input (RCA, etc.).
- Do not connect a power cord from another product to the **[MASTER 1]** terminals.

- Do not connect the **[MASTER 1]** terminals to a terminal that can supply phantom power.
- Use the **[BOOTH]** terminals for balanced output only. Connecting the terminals to unbalanced inputs with a TRS-RCA conversion cable (conversion adapter) or TS cable, etc. results in unwanted noises and/or poor sound quality.

---

---

## Step-by-step connections

- 1 Connect headphones to one of the PHONES terminals on the front panel.**
- 2 Connect an output device such as a power amplifier to the [MASTER 1] or [MASTER 2] terminals.**
  - To use a booth monitor, connect it to the **[BOOTH]** terminals.
- 3 Connect a PC/Mac to the unit with a USB cable.**
- 4 Turn the PC/Mac on.**
- 5 Connect the AC adapter to the unit.**
- 6 Turn the unit on.**
  - The “Getting Windows ready” message may appear if you’re using a PC (Windows). Wait until the PC gets ready.
  - If you use an input device such as a microphone or DJ player, turn the device on.
- 7 Turn on the device connected to the [MASTER 1] or [MASTER 2] terminals.**

---

---

# Serato DJ Pro

Serato DJ Pro is DJ software from Serato Limited.

The Serato DJ Pro software isn't included with the unit. Download the software from the URL below.

[serato.com/dj/pro/downloads](http://serato.com/dj/pro/downloads)

- For information on the latest system requirements, compatibility, and supported operating systems, visit the URL below.

[serato.com/dj/pro/downloads](http://serato.com/dj/pro/downloads)

- Operation isn't guaranteed on all PC/Mac models, even if the system requirements are met.
- Depending on power-saving settings and other conditions of your PC/Mac, the CPU and hard disk may not provide sufficient processing capabilities. For laptops in particular, make sure the PC/Mac is in the best condition to provide constant high-level performance when using Serato DJ Pro (for example by keeping the AC power connected).

---

---

## Installing Serato DJ Pro

- Do not connect your PC/Mac to the unit until the installation is complete.
- Close all applications running on your PC/Mac before starting the installation.

### ❖ For Mac

**1 Unzip the downloaded Serato DJ Pro software file.**

**2 Double-click the unzipped software file.**

The installer launches.

**3 Read the License Agreement terms carefully.  
If you agree to the terms, click [Agree].**

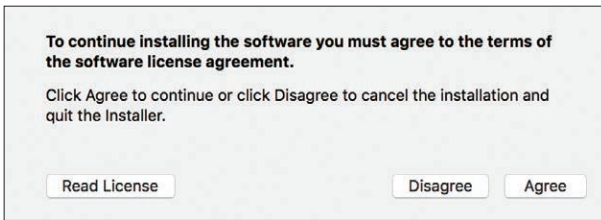

- If you don't agree to the License Agreement terms, click **[Disagree]** to cancel the installation.

## 4 Click **[Install]**.

## 5 Follow the on-screen instructions to complete the installation.

## 6 Click **[Close]**.

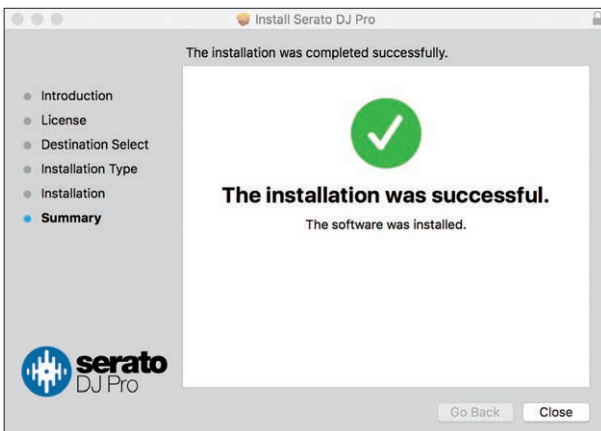

The installer closes.

## ❖ For Windows

### 1 Log in to your PC (Windows) with admin rights.

### 2 Unzip the downloaded Serato DJ Pro software file.

### 3 Double-click the unzipped software file.

The installer launches.

## 4 Read the License Agreement terms carefully.

If you agree to the terms, select **[I agree to the license terms and conditions]** then click **[Install]**.

- If you don't agree to the License Agreement terms, click **[Close]** to cancel the installation.

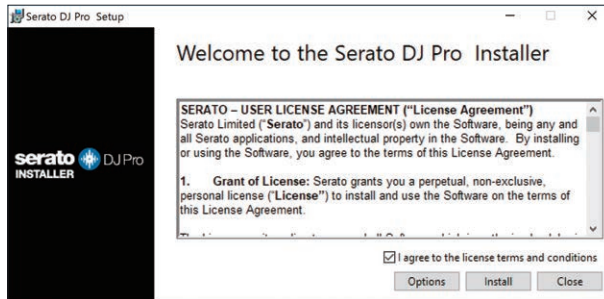

The installation completion screen appears when it's finished.

## 5 Click **[Close]**.



The installer closes.

---

---

## Basic operations for Serato DJ Pro

This section describes the basic operations for using Serato DJ Pro with the unit.

- For details on the operations of Serato DJ Pro, refer to the Serato DJ Pro software manual (page 6).
- Connect your PC/Mac to the unit correctly beforehand (page 36).

---

---

## Launching Serato DJ Pro

This section focuses on the functions of the hardware of the unit.

- For details on the operations of Serato DJ Pro, refer to the Serato DJ Pro software manual (page 6).

### ❖ For Mac

- 1 Open the [Applications] folder in Finder.
- 2 Click [Serato DJ Pro].

### ❖ For Windows 11

- 1 Open the Start menu and click [All Apps] → [Serato] → [Serato DJ Pro].

### ❖ For Windows 10

- 1 Open the Start menu and click [Serato] → [Serato DJ Pro].

## Serato DJ Pro screen immediately after it launches



- You don't need to activate the software or buy the license when you use the DDJ-REV5. When you launch Serato DJ Pro for the first time, [Login to Serato.com] may be displayed on the right side of the screen. Log in to your account to activate any expansion packs you own.

---

## Importing a track

The following instructions describe the basic operation to import tracks to Serato DJ Pro.

- For other importing methods, refer to the Serato DJ Pro software manual (page 6).
- In Serato DJ Pro, you can use libraries created with other DJ software from Serato Limited, such as Scratch Live, ITCH, Serato DJ Intro, and Serato DJ Lite.  
To use a library created with Serato DJ Intro, you may need to analyze tracks when using Serato DJ Pro.

### 1 Click [Files] on the Serato DJ Pro screen.

The [Files] panel opens and the contents of the PC/Mac and any connected devices (e.g. external hard drives) are displayed.

### 2 Click a folder which include tracks you want to add to the library.

The folder is selected.

### 3 Drag and drop the selected folder to the crates list.

A crate is created and the tracks are added to the library.



2

1. Files panel
2. crates list

## Loading a track to a deck

- 1 Press the [BACK] button to move the cursor to the crates list.**
- 2 Turn the rotary selector to highlight a crate.**
- 3 Press the rotary selector.**

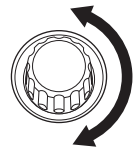

The cursor moves to the track list of the selected crate.

- 4 Turn the rotary selector to highlight a track.**
- 5 Press the [LOAD] button.**

The track is loaded to the corresponding deck.



## Serato DJ Pro screen when a track is loaded

Click [**Library**] in the top left of the screen and select [**Vertical**] or [**Horizontal**] from the pull-down menu to switch the Serato DJ Pro screen.

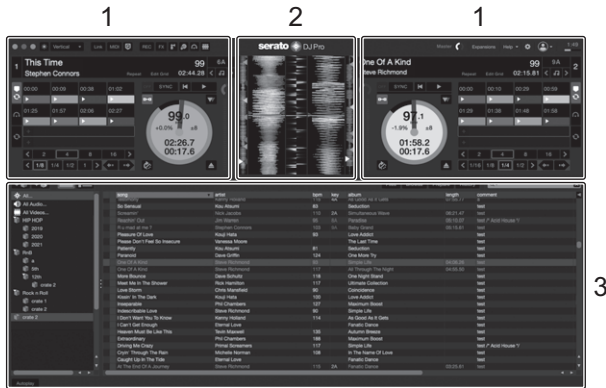

### 1. Deck panel

Displays the name of the loaded track as well as the artist name, track information such as BPM, and the overall waveform.

### 2. Waveform panel

Displays the waveform for the loaded track.

### 3. Browse panel

Displays tracks in a library or crate.

---

## Playback

---

---

### Play/pause

#### 1 Press the button.

During pause: Starts playing the loaded track.

During playback: Pauses the track.

---

### Reverse playback

#### 1 Press the [CENSOR ] button.

The loaded track plays in reverse (Slip Reverse) until you release the button (page 72).

- Press the [CENSOR ] button while pressing the [SHIFT] button to start reverse playback. Reverse playback continues even after you release the button. Press the buttons at the same time again to resume normal playback.
  - Maintaining reverse playback from one track to the next isn't possible.
  - You may not be able to scratch if you start loop playback, etc. during reverse playback.
- 

### Adjusting the playback speed (tempo control)

#### 1 Move the Tempo slider.

To the [+] side: Increases the playback speed.

To the [-] side: Decreases the playback speed.

- The variable range of the Tempo slider changes in the order of  $\pm 8\% \rightarrow \pm 16\% \rightarrow \pm 50\% \rightarrow \pm 100\% \rightarrow \pm 8\%$ ... each time you press the [RANGE] button.
- Press the [RANGE] button while pressing the [SHIFT] button to reset to the track's original speed regardless of the Tempo slider's setting.

---

## Adjusting the playback speed without changing the pitch (Key Lock)

If you turn Key Lock on, you can change the playback speed of a track using the Tempo slider without changing the pitch.

### 1 Press the [Key Lock] button to turn Key Lock on.

The button lights up when Key Lock is turned on.

- Press the [Key Lock] button again to turn Key Lock off.

---

## Using the jog wheels

You can use the following features in combination with the jog wheel.

Function	Description
Scratch	Turn the jog wheel while touching the top during playback in Vinyl mode to scratch a track. Release the jog wheel to resume normal playback.
Pitch Bend	Turn the outer section of the jog wheel, or turn the top of the jog wheel when Vinyl mode isn't turned on to adjust the playback speed.
Jog Skip	Turn the top of the jog wheel while pressing the [SHIFT] button to cycle through tracks with extra speed according to the rotation direction. If you release the [SHIFT] button, it changes to scratch operation and you can fine-adjust the playback position.

---

## Beat Sync

If you turn Beat Sync on, BPM and the beat position of tracks on the left and right decks automatically synchronize.

- Beat Sync can't be used with tracks that haven't been analyzed by Serato DJ Pro.

**1 Play a track that has been analyzed by Serato DJ Pro on the Deck 1 or Deck 2.**

**2 Press the [SYNC] button on the deck to synchronize a track with the track playing on another deck.**

Beat Sync turns on.

- Press the [SYNC] button while pressing the [SHIFT] button to turn Beat Sync off.

---

## Key Sync

If you turn Key Sync on, the keys of tracks on the left and right decks are automatically matched.

- You can't adjust the key for tracks that haven't been analyzed by Serato DJ Pro.

**1 Play a track that has been analyzed by Serato DJ Pro on Deck 1 or Deck 2.**

**2 Press the [KEY -] button while pressing the [SHIFT] button on the deck to match the key of the track with the one playing on the other deck.**

Key Sync turns on.

The key is adjusted to the key with the least change among the following.

- Same key
- Dominant key
- Subdominant key
- Relative key
- Relative key of dominant key

— Relative key of subdominant key

- Press the [KEY +] button while pressing the [SHIFT] button to reset to the original key.

---

---

## Loop

---

### Setting a loop automatically

- 1 Press the [AUTO LOOP] button during playback.

Loop playback starts from the position where the button is pressed.

---

### Setting a loop manually

- 1 Press the [SHIFT] and [1/2X] buttons at the point where you want to start the loop (loop-in point) during playback.
- 2 Press the [SHIFT] and [2X] buttons at the point where you want the loop to end (loop-out point).

Loop playback of the specified section starts.

---

### Halving the length of a loop

- 1 Press the [1/2X] button during loop playback.

The loop length is halved each time you press the button.

---

### Doubling the length of a loop

- 1 Press the [2X] button during loop playback.

The loop length is doubled each time you press the button.

## Fine-adjusting loop points

**1 Press the [1/2X] or [2X] button while pressing the [SHIFT] button during loop playback.**

- [1/2X]: Adjusts the loop-in point.
- [2X]: Adjusts the loop-out point.

**2 Turn the jog wheel to fine-adjust the loop point.**

- Press the [1/2X] or [2X] button while pressing the [SHIFT] button to resume loop playback.

## Performance Pads

You can use 2 modes at the same time using Performance Pads and Deck Pads (page 66).

### Pad mode buttons

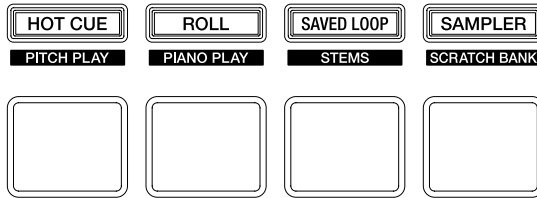

The unit switches to the following modes depending on how you operate the Pad mode buttons.

Operation	[HOT CUE] button	[ROLL] button	[SAVED LOOP] button	[SAMPLER] button
Press	Hot Cue mode	Roll mode	Saved Loop mode	Sampler mode
Press while pressing the [SHIFT] button	Pitch Play mode	Piano Play mode	Stems mode	Scratch Bank mode
Press twice	Saved Flip mode	Slicer Loop mode	User mode 1	User mode 2

### Combo Pad mode

If you press a Pad mode button while pressing another Pad mode button, you can use 2 Pad modes at the same time (the supported modes are Hot Cue, Roll, Saved Loop, and Sampler modes).

The Pad mode of the button you press first is assigned to the top 4 Performance Pads and the Pad mode of the button you press next is assigned to the bottom 4 Performance Pads. The Pad modes assigned to the top and bottom Performance Pads work as Pads 1 to 4 respectively.

---

## Hot Cue mode

You can call up a Hot Cue quickly and start playback by pressing a Performance Pad.

- You can set up to 8 Hot Cues per track.
- You can also use the Deck Pads (pad buttons) to control Hot Cues (page 66).

### 1 Press the [HOT CUE] button.

The unit switches to Hot Cue mode.

### 2 Press a Performance Pad at the point where you want to set a Hot Cue during playback or pause.

A Hot Cue is set.

- Hot Cues are assigned to Performance Pads as follows.

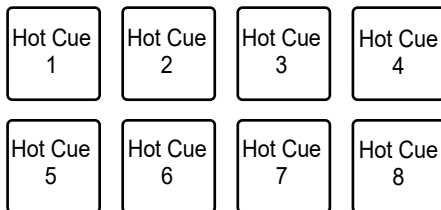

### 3 Press a Performance Pad that has a Hot Cue set.

Playback starts from the Hot Cue point.

- Press a Performance Pad while pressing the [SHIFT] button to clear a Hot Cue point set to the pad.



---

## Roll mode

Loop Roll playback continues according to the number of beats assigned to a Performance Pad while you press the pad.

### 1 Press the [ROLL] button.

The unit switches to Roll mode.

### 2 Press the [PARAMETER 1 ◀] or [PARAMETER 1 ▶] button.

The numbers of beats assigned to Performance Pads change as follows each time the button is pressed:

- 1/32 to 4 beats
- 1/16 to 8 beats
- 1/8 to 16 beats
- 1/4 to 32 beats

Example: When set to 1/8 to 16 beats, the numbers of beats are assigned to the Performance Pads as follows:

1/8	1/4	1/2	1
2	4	8	16

The numbers of beats are displayed on the Serato DJ Pro screen.



### 3 Press the Performance Pad assigned with the number of beats you want to play in a loop.

Loop Roll playback continues according to the number of beats assigned to the Performance Pad until you release the pad.

- Press the [1/2X] or [2X] button during Loop Roll playback to change the number of beats in Loop Roll being played.

- Normal playback continues with its original rhythm in the background during Loop Roll playback, but you can't hear this.
- Release the Performance Pad to end Loop Roll playback. Normal playback starts from the exact point the track would have reached by then.

---

## Saved Loop mode

You can save a loop to a loop slot in Serato DJ Pro and call up the saved loop.

- You can also use the Deck Pads (pad buttons) to control Saved Loop mode (page 68).

### 1 Press the [SAVED LOOP] button.

The unit switches to Saved Loop mode.

### 2 Press a Performance Pad during loop playback.

Loops are assigned to the loop slots in Serato DJ Pro as follows:

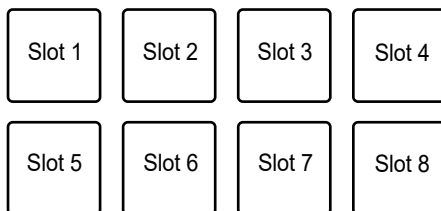

### 3 Press a Performance Pad assigned with a loop while pressing the [SHIFT] button.

Loop playback starts from the beginning of the loop.

- Press the [PARAMETER 1 ◀] or [PARAMETER 1 ▶] button during loop playback to change the length of the loop that's playing. The setting of the loop is overwritten with the new setting.
- Press the [PARAMETER 1 ◀] or [PARAMETER 1 ▶] button while pressing the [SHIFT] button during loop playback to move a loop without changing the loop length. The setting of the loop is overwritten with the new setting.
- Press the Performance Pad again to cancel loop playback.

---

## Sampler mode

You can start playback of a track loaded in a Sampler slot using a Performance Pad.

- You can also use the Deck Pads (pad buttons) to control Sampler mode (page 69).

### 1 Display the [SAMPLER] panel on the Serato DJ Pro screen.

### 2 Press the [SAMPLER] button on the unit.

The unit switches to Sampler mode.

### 3 Press the [PARAMETER 1 ◀] or [PARAMETER 1 ▶] button to switch Sampler Banks.

There are 4 banks (A, B, C, D) to switch between.

- Each bank has 8 slots.

### 4 Drag and drop a track to each slot on the [SAMPLER] panel to load it on the Serato DJ Pro screen.

The Sampler settings and the loaded tracks are saved.

### 5 Press a Performance Pad matching the slot (track) you want to play.

Slot playback starts.

- Slots are assigned to Performance Pads as follows:

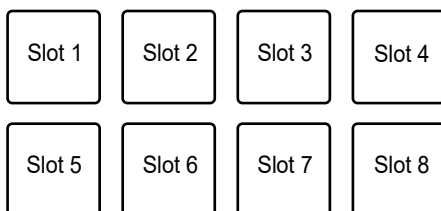

### 6 Turn the [SAMPLER VOLUME] knob to adjust the volume of the Sampler sound.

- Playback methods differ according to the Sampler mode set in Serato DJ Pro. For details, refer to the Serato DJ Pro software manual (page 6).
- Press the Performance Pad while pressing the [**SHIFT**] button to stop slot playback.

---

## Pitch Play mode

Pitch Play is a function of Pitch 'n Time DJ.

- To use Pitch 'n Time DJ, activate the supplied license first. For details, visit the URL below.  
[serato.com](http://serato.com)

### 1 Press the [**HOT CUE**] button while pressing the [**SHIFT**] button.

The unit switches to Pitch Play mode.

### 2 Press a Performance Pad while pressing the [**SHIFT**] button.

The Hot Cue assigned to the Performance Pad is selected.

### 3 Press a Performance Pad.

Playback starts from the selected Hot Cue point according to the pitch assigned to the Performance Pad.

- Press the [**PARAMETER 1 ◀**] or [**PARAMETER 1 ▶**] button during Pitch Play playback to change the pitch range. Each press switches between Up range, Middle range, and Down range.

#### — Up range:

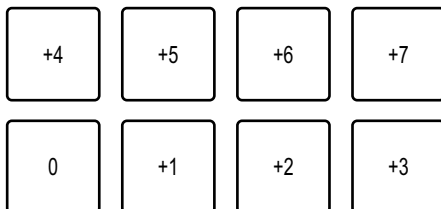

— **Middle range:**

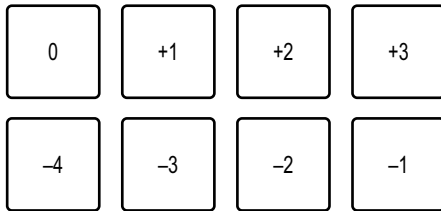

— **Down range:**

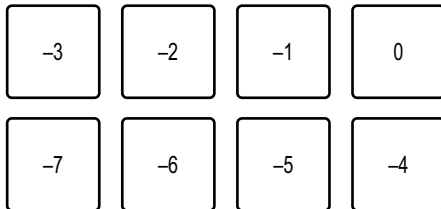

- Press the [**PARAMETER 1 ◀**] or [**PARAMETER 1 ▶**] button while pressing the [**SHIFT**] button to shift the pitch range by a semitone.

## Piano Play mode

### 1 Press the [**ROLL**] button while pressing the [**SHIFT**] button.

The unit switches to Piano Play mode.

- Pitches are assigned to the 16 Performance Pads in a piano layout. Pad mode on the other deck is disabled.

### 2 Press a Performance Pad while pressing the [**SHIFT**] button.

The Hot Cue point assigned to the Performance Pad is selected.

### 3 Press a Performance Pad.

Playback starts from the selected Hot Cue point according to the pitch assigned to the Performance Pad.

- Press the [**PARAMETER 1 ◀**] or [**PARAMETER 1 ▶**] button on the left deck to change the pitch range. Each press switches between Up range, Middle range, and Down range.

- Press the [PARAMETER 1 ◀] or [PARAMETER 1 ▶] button on the right deck to change the scale display for Performance Pads. The scale display changes in the order of minor pentatonic ↔ major ↔ major pentatonic. Pitches assigned to the Performance Pads don't change, even if the scale display is changed.

— **Up range:**

	+1	+3		+6	+8	+10	
0	+2	+4	+5	+7	+9	+11	+12

— **Middle range:**

-6	-4	-2		+1	+3		+6
-5	-3	-1	0	+2	+4	+5	+7

— **Down range:**

	-11	-9		-6	-4	-2	
-12	-10	-8	-7	-5	-3	-1	0

- The unit exits Piano Play mode if you do any of the following.
  - Switch to another pad mode.
  - Switch the deck with the [DECK] button.
  - Switch to another input source with the input selector switch.

---

## Stems mode

- 1 Press the **[SAVED LOOP]** button while pressing the **[SHIFT]** button.

The unit switches to Stems mode.

- 2 Press the **Performance Pad** assigned with the **Stem** you want to play.

- Stems are assigned to the Performance Pads as follows:

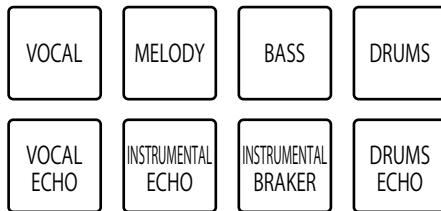

---

## Scratch Bank mode

You can load sound of a Scratch Bank.

- You can also use the Deck Pads (pad buttons) to control Scratch Bank mode (page 67).

- 1 Display the **[SCRATCH BANK]** panel on the **Serato DJ Pro** screen.

- 2 Press the **[SAMPLER]** button while pressing the **[SHIFT]** button on the unit.

The unit switches to Scratch Bank mode.

- 3 Press the **Performance Pad** assigned with the **Scratch Bank** you want to load.

Sound of the Scratch Bank are loaded to the unit.

- Slots are assigned to Performance Pads as follows:

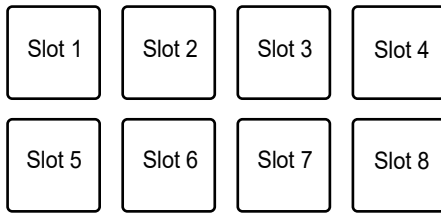

- Press a Performance Pad while pressing the **[SHIFT]** button to load the last loaded track.

---

## Saved Flip mode

Serato Flip is a function that enables you to record a sequence, or call up a recorded sequence, of Hot Cues. The recorded sequence of Hot Cues is called a Flip.

You can save and play a Flip using Performance Pads on the unit.

- To use Saved Flip mode, you need to buy and activate Serato Flip. For details, visit the URL below.

[serato.com](http://serato.com)

### ❖ Saving a Flip to a slot

#### 1 Create a Flip using Serato DJ Pro.

- For details on how to create a Flip, refer to the Serato DJ Pro software manual (page 6).

#### 2 Press the **[HOT CUE]** button twice.

The unit switches to Saved Flip mode.

#### 3 Press the Performance Pad for the slot you want to save the Flip to.

The Flip is saved to the slot.



- Slots are assigned to Performance Pads as follows:

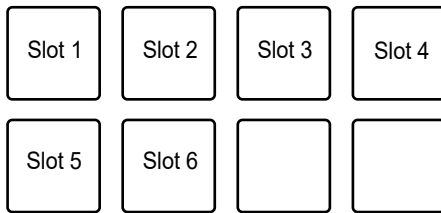

- You can't save a Flip to a slot if all slots have saved Flips already. Delete a Flip on the slot screen in Serato DJ Pro to free up a slot for a new Flip.

## ❖ Calling up and playing a Flip

### 1 Press the [HOT CUE] button twice.

The unit switches to Saved Flip mode.

### 2 Press the Performance Pad assigned with the slot (Flip) you want to play.

The Flip is called up and playback starts from the beginning of the Flip.

- Slots are assigned to Performance Pads as follows:

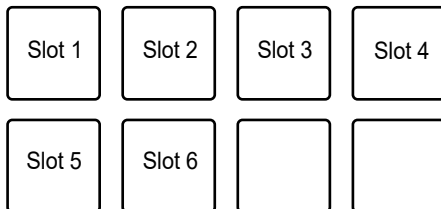

- If you call up a Flip by pressing a Performance Pad while pressing the [SHIFT] button, playback doesn't start from the beginning. Instead, Flip playback starts when the playback of the track reaches the beginning of the Flip.
- Press a Performance Pad during Flip playback to move to the beginning of the Flip that's playing.
- Press the Performance Pad while pressing the [SHIFT] button to cancel Flip playback and resume normal playback.

## Slicer Loop mode

A specified range is applied to the track and divided into 8 sections. The divided sections are assigned to different Performance Pads.

Loop playback of the section assigned to a Performance Pad continues while you press the Performance Pad.

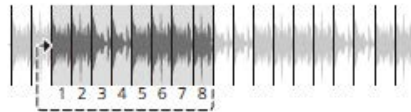

- You can't use Slicer Loop with a track that doesn't have beatgrid set. For details on how to set beatgrid, refer to the Serato DJ Pro software manual (page 6).

### 1 Press the [ROLL] button twice.

The unit switches to Slicer Loop mode.

### 2 Press the [PARAMETER 1 ◀] or [PARAMETER 1 ▶] button while pressing the [SHIFT] button to specify the range (DOMAIN) to divide into 8 sections.

- Each press of the button sets the domain as follows from the position where the button is pressed:
  - 2 beats
  - 4 beats
  - 8 beats
  - 16 beats
  - 32 beats
  - 64 beats
- The 8 sections of a divided domain are assigned to the Performance Pads as follows:
 

**Sections 1 to 8:**

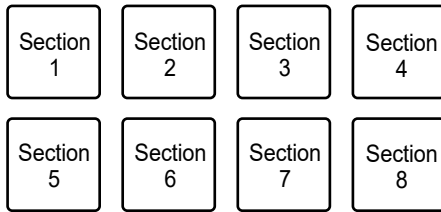

**Performance Pad assignment:**

### 3 Press the [PARAMETER 1 ◀] or [PARAMETER 1 ▶] button to set Quantization.

Each press of the button sets Quantization as follows:

- 1/8 (plays a loop of 1/8 length from the beginning of a section)
- 1/4 (plays a loop of 1/4 length from the beginning of a section)
- 1/2 (plays a loop of 1/2 length from the beginning of a section)
- 1 (plays the entire section)

### 4 Press the Performance Pad assigned with the section you want to play in a loop.

Loop playback continues until you release the Performance Pad.

- Normal playback continues with its original rhythm in the background during Slicer Loop playback, but you can't hear this.
- Release a Performance Pad to end Slicer Loop playback. Normal playback starts from the exact point the track would have reached by then.
- Playback returns to and continues from the beginning of section 1 if playback reaches the end of the domain.

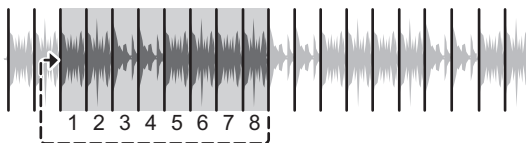

---

## User mode

You can assign DJ software functions to the Performance Pads on the unit using the MIDI assigning mode in most types of DJ software.

The unit supports two User modes and you can assign functions to 8 pads in each User mode.

This section describes an example of how to use User modes with Serato DJ Pro.

- Find out about the MIDI assigning mode of your DJ software in the relevant user manual.

### 1 Press the [SAVED LOOP] or [SAMPLER] button twice.

- [SAVED LOOP]: Switches to User mode 1.
- [SAMPLER]: Switches to User mode 2.

### 2 Click [MIDI] on the Serato DJ Pro screen.

Serato DJ Pro switches to MIDI assigning mode.

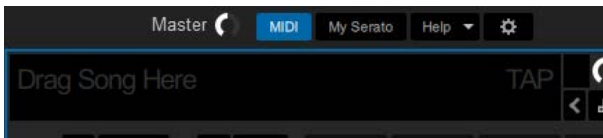

### 3 Click a function to assign to a Performance Pad on the unit.

Example: When assigning [▶] (PLAY/PAUSE)

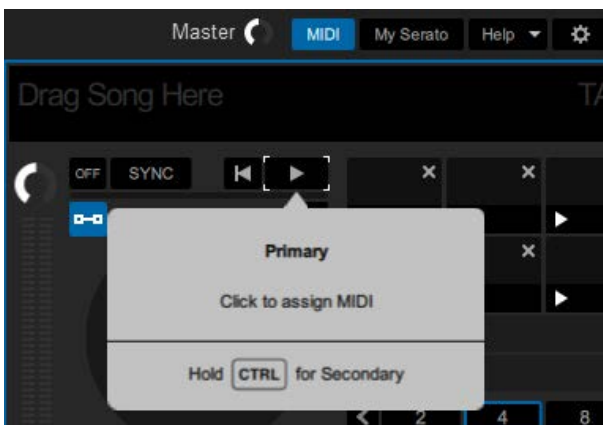

## 4 Press a Performance Pad to assign the selected function to.

If the assignment works, the confirmation message appears.

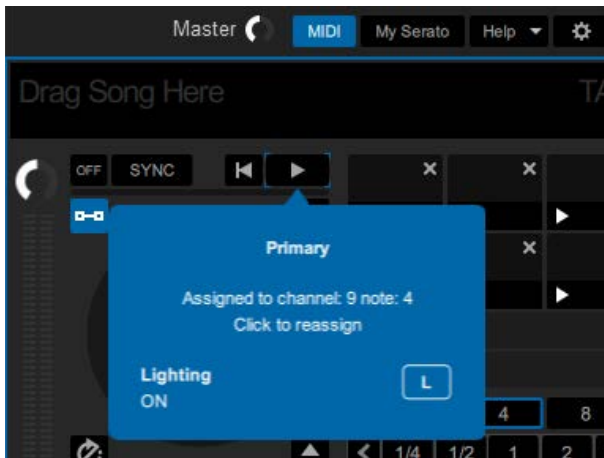

- Click **[MIDI]** to exit MIDI assigning mode.
- Switch to the relevant User mode after you've finished making settings to use the Serato DJ Pro functions assigned to the Performance Pads.

## Deck Pads

You can use 2 modes at the same time using Performance Pads (page 51) and Deck Pads.

### Deck Pads mode buttons

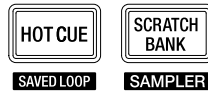

The unit switches to the following modes depending on how you operate the Deck Pads mode buttons.

Operation	[HOT CUE] button	[SCRATCH BANK] button
Press	Hot Cue mode	Scratch Bank mode
Press while pressing the [SHIFT] button	Saved Loop mode	Sampler mode

### Hot Cue mode

You can call up a Hot Cue quickly and start playback by pressing the Pad buttons ([VOCAL/PAD 1], [MELODY/PAD 2], [BASS/PAD 3], [DRUMS/PAD 4]).

- You can set up to 4 Hot Cues (1 to 4) per track.
- You can also use the Performance Pads to control Hot Cues (page 52).

#### 1 Press the [HOT CUE] button.

The unit switches to Hot Cue mode.

#### 2 Press a pad button at the point where you want to set a Hot Cue during playback or pause.

A Hot Cue is set.

- Hot Cues are assigned to the pad buttons as follows.

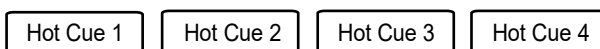

## 3 Press a pad button that has a Hot Cue set.

Playback starts from the Hot Cue point.

- Press a pad button while pressing the **[SHIFT]** button to clear a Hot Cue point set to the button.

---

## Scratch Bank mode

You can load sound of Scratch Bank slots 1 to 4.

- You can also use the Performance Pads to control Scratch Bank (page 59).

## 1 Display the **[SCRATCH BANK]** panel on the Serato DJ Pro screen.

## 2 Press the **[SCRATCH BANK]** button on the unit.

The unit switches to Scratch Bank mode.

## 3 Press a pad button assigned with the Scratch Bank you want to load.

Sound of the Scratch Bank is loaded to the unit.

- Slots are assigned to the pad buttons as follows:



- Press a pad button while pressing the **[SHIFT]** button to load the last loaded track.

---

## Saved Loop mode

You can save loops to loop slots 1 to 4 in Serato DJ Pro and call up the saved loop.

- You can also use the Performance Pads to control Saved Loop mode (page 54).

### 1 Press the [HOT CUE] button while pressing the [SHIFT] button.

The unit switches to Saved Loop mode.

### 2 Press a pad button during loop playback.

Loops are assigned to the loop slots in Serato DJ Pro as follows:



### 3 Press a pad button assigned with a loop while pressing the [SHIFT] button.

Loop playback starts from the beginning of the loop.

- Press the pad button again to cancel loop playback.



---

## Sampler mode

You can start playback of a track loaded in Sampler slots 1 to 4 using the pad buttons.

- You can also use the Performance Pads to control Sampler mode (page 55).

### 1 Display the [SAMPLER] panel on the Serato DJ Pro screen.

### 2 Press the [SCRATCH BANK] button while pressing the [SHIFT] button on the unit.

The unit switches to Sampler mode.

### 3 Drag and drop a track to each slot on the [SAMPLER] panel to load it on the Serato DJ Pro screen.

The Sampler settings and the loaded tracks are saved.

### 4 Press a pad button matching the slot (track) you want to play.

Slot playback starts.

- Slots are assigned to the pad buttons as follows:



### 5 Turn the [SAMPLER VOLUME] knob to adjust the volume of the Sampler sound.

- Playback methods differ according to the Sampler mode set in Serato DJ Pro. For details, refer to the Serato DJ Pro software manual (page 6).
- Press a pad button while pressing the [SHIFT] button to stop slot playback.

---



---

## Dual Deck mode

You can simultaneously control Decks 1 and 3 (or Decks 2 and 4) in Dual Deck Mode.



You can scratch or play a loop/Hot Cue, etc., as if the two different tracks are combined as one track.

### 1 Press the [DECK] button while pressing the [SHIFT] button.

The unit switches to Dual Deck mode.

- Deck 1 and Deck 2 become active. You can't change the active decks.
- Press the [DECK] button while pressing the [SHIFT] button to turn Dual Deck mode off.
- You can control the following functions in Dual Deck mode with the relevant buttons and knobs.

Buttons/knobs	Function
Jog wheel	Playback operations of the decks
[TRIM] knob	Volume adjustment
[HI, MID, LOW] knobs	EQ adjustment
Channel fader	Volume adjustment
Crossfader	Volume adjustment
[FILTER] knob	Effect adjustment
Effect lever	Effect control
Performance Pads	Performance Pads control
Loop operation buttons	Loop control
[SYNC] button	BPM matching
[KEY LOCK] button	Key Lock
Deck Pads buttons	Deck Pads control (modes other than Stems mode)

Buttons/knobs	Function
[SLIP] button	Slip mode
[CENSOR  ] button	Slip reverse
[KEY -], [KEY +] buttons	Key adjustment
[CUE] button	Cue point control
 button	Play/pause
 [CUE] button	Headphones monitoring

## Auto BPM Transition

The unit can help with your mixing by automatically adjusting a track's BPM.

With this function, you can use other controls while BPM automatically transits as you don't have to manually adjust the tempo slider.

You can choose a Stem that will automatically be output when the BPM Transition starts in advance.





**1 Press one of the pad buttons ([VOCAL/PAD 1], [MELODY/PAD 2], [BASS/PAD 3], [DRUMS/PAD 4]) while pressing the [SELECT] button to select a Stem to output during Auto BPM Transition.**

- Press the [KEY LOCK] or [AUTO LOOP] button while pressing the [SELECT] button to select the status during Auto BPM Transition.

**2 Press the [SELECT] button while pressing the [SHIFT] button to select the number of bars (how long the transition takes).**

**3 Press the  (Auto BPM Transition Start) button.**

Auto BPM Transition starts.

- If you press the  (Auto BPM Transition Start) button when the Sync function is turned off on the other deck, the tempo will gradually change to match the BPM of the track on the other deck. The BPM will match when the set number of bars passes and Auto BPM Transition will automatically end.
  - If you press the  (Auto BPM Transition Start) button when the Sync function is turned on the other deck, the tempo will gradually change to match the original BPM of the track on the other deck. The BPM will match when the set number of bars passes and Auto BPM Transition will automatically end.
  - If you press the  (Auto BPM Transition Start) button while pressing the **[SELECT]** button, the tempo will gradually change to match the original BPM of the track on the deck you are operating. The BPM will match when the set number of bars passes and Auto BPM Transition will automatically end.
- Press the  (Auto BPM Transition Start) button again to end Auto BPM Transition.

---





---

## Slip

If you turn Slip mode on, normal playback continues in the background (but you can't hear it) when you perform the following operations.

When you end the operation, Slip is canceled and normal playback starts from the exact point the track would have reached by then. This means the original rhythm remains constant and your performance stays perfectly in time.

Function	Description
Slip Pause	If you press the  button during playback, playback continues in the background during the pause.
Slip Scratch	If you scratch a track using the jog wheel, normal playback continues in the background while you are scratching.
Slip Loop	If you start loop playback (page 49), normal playback continues in the background while the loop is playing.
Slip Reverse	If you press the <b>[CENSOR </b> ] button during playback, playback is reversed (page 46). Normal playback continues in the background during reverse playback.

Function	Description
Slip Hot Cue	If you press a Performance Pad (page 52) or a pad button (page 66) with a Hot Cue set during playback, the playback point jumps to the Hot Cue point and playback continues until you release the pad/button. Normal playback continues in the background during Hot Cue playback.

## 1 Press the [SLIP] button.

Slip mode turns on and the [SLIP] button lights up.

- The [SLIP] button blinks while Slip is in use.
- Press the [SLIP] button again or load a track to turn Slip mode off.

---



---

## Fader Start

You can start playback by moving the fader knobs.

---

### Using Channel Fader Start

#### 1 Select [CUE] or [HOT CUE] in [Fader Start options.] on the [PREFERENCES] tab in Setting Utility.

➤ Read more: Changing the settings (page 33)

#### 2 Move the channel fader up from the bottom position while pressing the [SHIFT] button.

Playback of the track starts from the cue point.

- Move the channel fader back to the bottom position while pressing the [SHIFT] button during playback to quickly return to the cue point and pause playback (Back Cue).
- If a cue isn't set, playback starts from the beginning of the track.
- You can set whether the Sync function will turn on when Channel Fader Start is triggered (only for use with Serato DJ Pro) on the [PREFERENCES] tab in Setting Utility (page 33).

---

## Using Crossfader Start

**1 Select [CUE] or [HOT CUE] in [Fader Start options.] on the [PREFERENCES] tab in Setting Utility.**

 Read more: Changing the settings (page 33)

**2 Set the crossfader all the way to the left side or right side.**

- Set the crossfader to the opposite side of the channel which starts playback via Crossfader Start.

**3 Move the crossfader away from the left or right side while pressing the [SHIFT] button.**

Playback of the track starts from the cue point.

- Move the crossfader all the way back to the left or right side while pressing the [SHIFT] button during playback to quickly return to the cue point and pause playback (Back Cue).
- If a cue isn't set, playback starts from the beginning of the track.

---

## Using effects

You can control Serato DJ Pro effects with the unit.

### 1 Press the [FX SELECT] button assigned with the effect you want to use.

- If you press multiple [FX SELECT] buttons with software effects assigned, you can use multiple software effects at the same time.
- Turn the rotary selector while pressing the [FX SELECT] button to select an effect type.

### 2 Press the [BEAT ◀] or [BEAT ▶] button to set the number of beats to synchronize the effect with.

### 3 Turn the [LEVEL/DEPTH] knob to adjust the effect.

- Turn the knob all the way counterclockwise to output the original sound.

### 4 Set the effect lever to [ON] or [LOCK ON].

The selected effect is applied to the sound of the channel on which you're using the effect lever.

---

---

# rekordbox

rekordbox is a complete DJ application you can use to manage your music and perform.

- This unit is a Hardware Unlock device. If you connect a PC/Mac running rekordbox to the unit, you can use Performance mode (rekordbox DJ functions) for free.
- For information on functions supported by Hardware Unlock, visit the URL below.

[rekordbox.com](http://rekordbox.com)

- The rekordbox software isn't included with the unit. Download rekordbox for Mac/Windows from the URL below.

[rekordbox.com](http://rekordbox.com)

- For information on the latest system requirements, compatibility, and supported operating systems, visit the URL below.

[rekordbox.com/system](http://rekordbox.com/system)

- Use the latest version and service pack for the supported OS.
- To use the internet, a separate contract with, and payment to, a provider is required.
- Operation isn't guaranteed on all PC/Mac models, even if the system requirements are met.
- Depending on power-saving settings and other conditions of your PC/Mac, the CPU and hard disk may not provide sufficient processing capabilities. For laptops in particular, make sure the PC/Mac is in the best condition to provide constant high-level performance when using rekordbox (for example by keeping the AC power connected).



# Installing rekordbox

Install the latest version of rekordbox as follows.

- If rekordbox has already been installed, update to the latest version from the update manager displayed when rekordbox is started.
- Do not connect your PC/Mac to the unit until the installation is complete.
- Close all applications running on your PC/Mac before starting the installation.

## ❖ For Mac

### 1 Unzip the downloaded rekordbox software file.

### 2 Double-click the unzipped software file.

The installer launches.

### 3 Read the License Agreement terms carefully. If you agree to the terms, click [Agree].

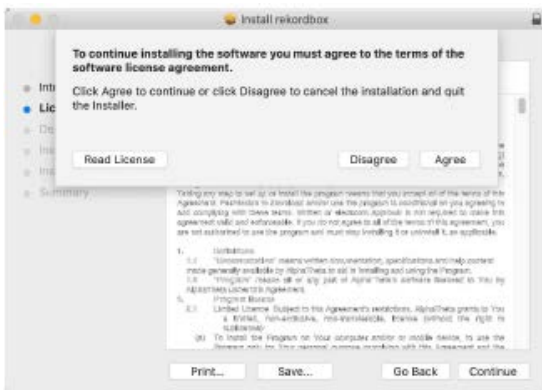

The installation starts.

- If you don't agree to the License Agreement terms, click [Disagree] to cancel the installation.

### 4 After the installation completion screen appears, click [Close].

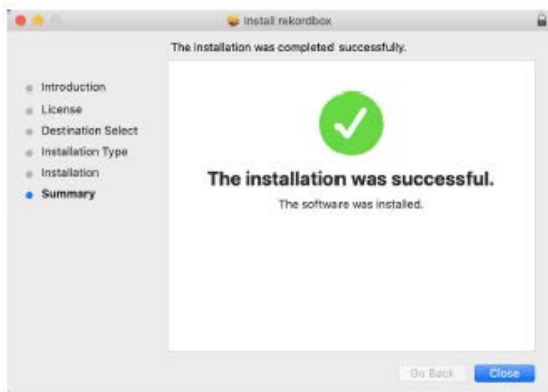

The installer closes.

## ❖ For Windows

**1 Log in to your PC (Windows) with admin rights.**

**2 Unzip the downloaded rekordbox software file.**

**3 Double-click the unzipped software file.**

The installer launches.

**4 Read the License Agreement terms carefully.  
If you agree to the terms, select [Agree] then click [Next].**

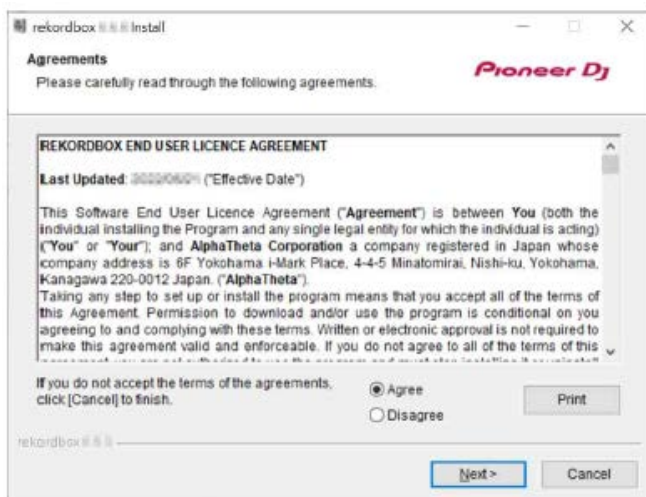

- If you don't agree to the License Agreement terms, click **[Cancel]** to cancel the installation.

## 5 Specify the installation path.

The installation starts.

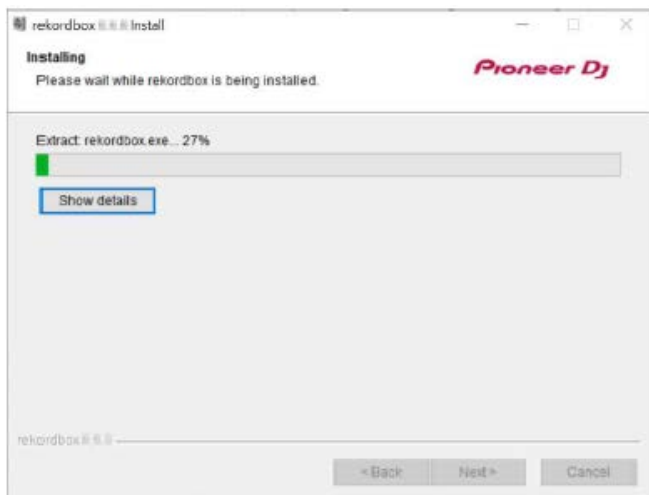

## 6 After the installation completion screen appears, click **[Finish]**.

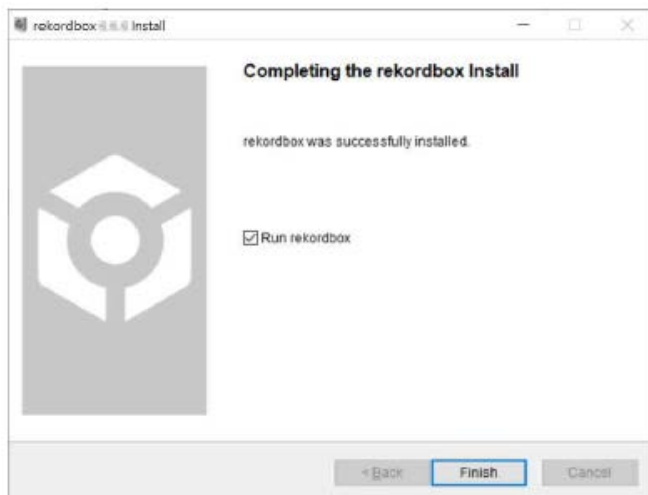

The installer closes.

---

## Basic operations for rekordbox

This section describes the basic operations for using rekordbox with the unit.

- To use rekordbox, you'll first need to register for a free Pioneer DJ account. For details, refer to the rekordbox Introduction (page 6).

---

### Launching rekordbox

#### ❖ For Mac

- 1 Open the [Applications] folder in Finder.
- 2 Click the [rekordbox 6] folder.
- 3 Double-click [rekordbox.app].

#### ❖ For Windows 11

- 1 Open the Start menu and click [All Apps] → [Pioneer] → [rekordbox 6].

#### ❖ For Windows 10

- 1 Open the Start menu and click [Pioneer] → [rekordbox 6].

---

## Checking the audio settings

### 1 Click [Preferences] and check if the [Audio] settings are set as follows in rekordbox.

- For Mac:
  - [Audio]: [DDJ-REV5]
  - [Output channels]:
    - [Master Output]: [DDJ-REV5: MASTER + Audio device name in Mac]
    - [Headphones Output]: [DDJ-REV5: PHONES]
- For Windows:
  - [Audio]: [DDJ-REV5 ASIO]
  - [Output channels]:
    - [Master Output]: [DDJ-REV5 ASIO: MASTER + Audio device name in PC]
    - [Headphones Output]: [DDJ-REV5 ASIO: PHONES]
- When [PC MASTER OUT] (the function that outputs the master sound from the PC/Mac speakers, which is turned on by default) is turned off, [Master Output] in the [Audio] settings is automatically set to [DDJ-REV5: MASTER] (for Mac)/[DDJ-REV5 ASIO: MASTER] (for Windows).
- If you don't want to output the master sound from the PC/Mac speakers, click  in the upper right corner of the rekordbox screen to turn it off.

---

## Analyzing a track

If you import tracks from your PC/Mac to your rekordbox Collection (the screen that displays the list of tracks managed by rekordbox), the tracks are analyzed and you can use them with rekordbox.

### 1 Click [Collection] in the tree view.

The list of tracks in [Collection] is displayed.

### 2 Open Finder or File Explorer, then drag and drop tracks or folders containing tracks to the track list.

The tracks are added to [Collection] and the analysis of the tracks starts.

- Wait until analysis of all the tracks is complete.
- If you load a track which hasn't been analyzed to a deck, it may take some time to display its BPM and waveform.
- It may take some time to analyze tracks, depending on how many there are.

---

## Loading a track to a deck

### 1 Turn the rotary selector to highlight a track in [Collection].

### 2 Press the rotary selector.

The track is loaded to the deck.

---

## Playing a track

### 1 Set the knobs, etc. as follows on the deck that plays a track.

- **Input selector switch:** [ A]
- **[TRIM] knob:** Turn all the way counterclockwise
- **[HI, MID, LOW] knobs:** Center position
- **[FILTER] knob:** Center position
- **Channel fader:** Bottom position
- **[MASTER LEVEL] knob:** Turn all the way counterclockwise
- **Crossfader:** Center position

### 2 Press the button to play the track.

### 3 Turn the [TRIM] knob.

- Adjust the [TRIM] knob so the channel level indicator lights up in orange at the peak level.

### 4 Move the channel fader up.

### 5 Turn the [MASTER LEVEL] knob to properly adjust the sound output from the [MASTER 1]/[MASTER 2] output terminals.

- To output sound from the speakers of PC/Mac, adjust the volume for the speakers on the PC/Mac.
- If sound isn't output from the [MASTER 1]/[MASTER 2] output terminals or your PC/Mac isn't recognized by the unit after it's connected to the unit, refer to the [FAQ] for the DDJ-REV5 at the URL below.

[pioneerdj.com/support/](http://pioneerdj.com/support/)

---

## Monitoring with headphones

### 1 Connect headphones to one of the PHONES terminals.

➡ Read more: Connecting to the input terminals (page 36)

### 2 Set the knobs in the Headphones section as follows.

- [MIX] knob: Center position
- [LEVEL] knob: Turn all the way counterclockwise

### 3 Press the [ CUE CH 1] or [ CUE CH 2] button.

### 4 Turn the [LEVEL] knob to adjust the volume output from the headphones.

---

## Closing rekordbox

### 1 Click [, or click [File] → [Exit].



---

---

## Loop

---

---

### Setting a loop automatically

- 1 Press the **[AUTO LOOP]** button during playback.

Loop playback starts from the position where the button is pressed.

---

---

### Setting a loop manually

- 1 Press the **[SHIFT]** and **[1/2X]** buttons at the point where you want to start the loop (loop-in point) during playback.
- 2 Press the **[SHIFT]** and **[2X]** buttons at the point where you want the loop to end (loop-out point).

Loop playback of the specified section starts.

---

---

### Halving the length of a loop

- 1 Press the **[1/2X]** button during loop playback.

The loop length is halved each time you press the button.

---

---

### Doubling the length of a loop

- 1 Press the **[2X]** button during loop playback.

The loop length is doubled each time you press the button.

---

## Fine-adjusting loop points

### 1 Press the [1/2X] or [2X] button while pressing the [SHIFT] button during loop playback.

- [1/2X]: Adjusts the loop-in point.
- [2X]: Adjusts the loop-out point.

### 2 Turn the jog wheel to fine-adjust the loop point.

- After fine-tuning, press the [1/2X] or [2X] button while pressing the [SHIFT] button to resume loop playback.

## Performance Pads

You can switch functions with the pad mode buttons ([HOT CUE], [ROLL], [SAVED LOOP], [SAMPLER]).

### Pad mode buttons

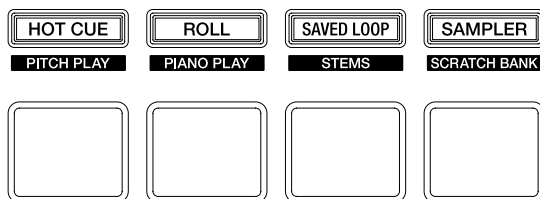

The unit switches to the following modes depending on how you operate the pad mode buttons.

Operation	[HOT CUE] button	[ROLL] button	[SAVED LOOP] button	[SAMPLER] button
Press	Hot Cue mode	Pad FX mode	Beat Jump mode	Sampler mode
Press while pressing the [SHIFT] button	Keyboard mode	Piano Play mode	Beat Loop mode	Sample Scratch mode
Press twice	User mode 1	User mode 2	User mode 3	User mode 4

---

## Hot Cue mode

You can call up a Hot Cue quickly and start playback by pressing a Performance Pad.

- You can also call up a loop instead of a Hot Cue.
- You can set up to 16 Hot Cues per track, however you can set or call up 8 Hot Cues using the unit.

### 1 Press the [HOT CUE] button.

The unit switches to Hot Cue mode.

### 2 Press a Performance Pad at the point where you want to set a Hot Cue during playback or pause.

A Hot Cue is set.

- Hot Cues are assigned to Performance Pads as follows.

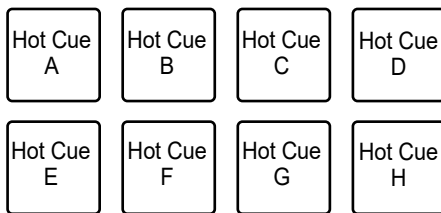

### 3 Press a Performance Pad that has a Hot Cue set.

Playback starts from the Hot Cue point.

- Press a Performance Pad while pressing the [SHIFT] button to clear a Hot Cue point set to the pad.
- You can perform Gate playback while a track is paused by marking the [During Pause, GATE playback is applied.] check box in [Preferences] → [Controller] → [Deck] → [Hot Cue].

## ❖ Setting a loop

### 1 Press the [HOT CUE] button.

The unit switches to Hot Cue mode.

### 2 Set a loop during playback.

Loop playback starts.

➡ Read more: Setting a loop automatically (page 85), Setting a loop manually (page 85)

### 3 Press a Performance Pad during loop playback.

A loop is set.

### 4 Press a Performance Pad that has a loop set.

Loop playback starts from the loop-in point.

- Press a Performance Pad while pressing the [SHIFT] button to clear a loop set to the pad.

## ❖ Calling up a cue point

You can call up a cue point or loop point saved in a Memory Cue of rekordbox.

### 1 Press the [HOT CUE] button.

The unit switches to Hot Cue mode.

### 2 Press the [PARAMETER 1 ◀] or [PARAMETER 1 ▶] button.

A cue point or loop point saved in a Memory Cue is called up.

- For details on Memory Cue, see the rekordbox Instruction Manual (page 6).

## Pad FX mode

You can apply effects using the Performance Pads.

### 1 Press the [ROLL] button.

The unit switches to Pad FX mode.

- Effects are assigned to the Performance Pads as follows.

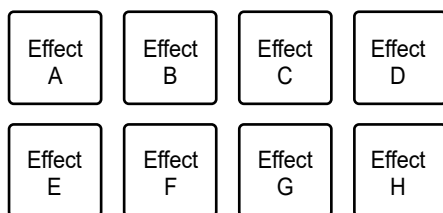

### 2 Press and hold the Performance Pad assigned with the effect you want to use.

The effect is applied according to the number of beats set to the Performance Pad while you press it.

- Release the Performance Pad to turn the effect off.
- Press the [PARAMETER 1 ◀] or [PARAMETER 1 ▶] button to change the number of beats.

### ❖ Using the Release FX of Pad FX

Assign a Release FX to the Performance Pads beforehand.

#### 1 Press and hold a Performance Pad assigned with an effect other than Release FX.

The effect is applied according to the number of beats set to the Performance Pad while you press it.

#### 2 Press a Performance Pad assigned with Release FX, then release it.

The effect that has been on until then is turned off and Release FX is turned on.

---

## Beat Jump mode

You can move the playback point quickly without breaking the rhythm of the track that's playing.

### 1 Press the [SAVED LOOP] button.

The unit switches to Beat Jump mode.

- The number of beats and bars are assigned to the Performance Pads by default as follows.

1 beat (to the left)	1 beat (to the right)	2 beats (to the left)	2 beats (to the right)
4 beats (to the left)	4 beats (to the right)	8 beats (to the left)	8 beats (to the right)

- Press the [PARAMETER 1 ◀] or [PARAMETER 1 ▶] button to change the number of beats or bars to assign to the Performance Pads.

### 2 Press the Performance Pad assigned with the number of beats and direction you want to jump.

The playback position moves by the number of beats and direction set for the pressed pad.

---

## Sampler mode

You can start playback of a track loaded in a Sampler slot using Performance Pads.

### ❖ Loading a track to the sampler slot

#### 1 Click **[SAMPLER]** on the rekordbox screen.

The **[SAMPLER]** panel is displayed.

#### 2 Press the **[SAMPLER]** button on the unit.

The unit switches to Sampler mode.

#### 3 Press the **[PARAMETER 1 ◀]** or **[PARAMETER 1 ▶]** button to switch Sampler Banks.

#### 4 Press the rotary selector to move the cursor to the track list.

#### 5 Turn the rotary selector to select a track to load to the sampler slot.

#### 6 While pressing the **[SHIFT]** button, press the Performance Pad matching the slot (track) you want to load.

The selected track is loaded to the sampler slot.

- You may not be able to load a track to a Sampler slot which already has a track loaded, depending on the **[Preferences]** settings in rekordbox.



## ❖ Playing a sampler

### 1 Press the [SAMPLER] button.

The unit switches to Sampler mode.

### 2 Press the [PARAMETER 1 ◀] or [PARAMETER 1 ▶] button to switch Sampler Banks.

### 3 Turn the [SAMPLER VOLUME] knob to adjust the volume of the Sampler sound.

### 4 Press the Performance Pad matching the slot (track) you want to play.

Slot playback starts.

- Slots are assigned to Performance Pads as follows (slots 1 to 8 are for Deck 1 and Deck 3, and slots 9 to 16 are for Deck 2 and Deck 4).

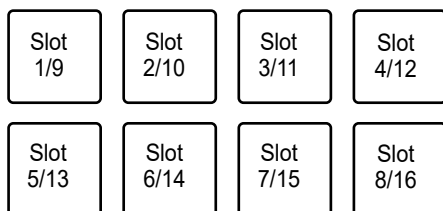

### 5 Press the Performance Pad during sampler playback.

Playback resumes from the beginning.

- Press the Performance Pad while pressing the [SHIFT] button to stop slot playback.

---

## Keyboard mode

You can use the Performance Pads as a keyboard to add musical scales to Hot Cues.

### 1 Press the [HOT CUE] button while pressing the [SHIFT] button.

The unit switches to Keyboard mode.

### 2 Press a Performance Pad that has a Hot Cue set.

- If a Hot Cue isn't set to the Performance Pad, the current playback point is set as a Hot Cue point.
- Press the [HOT CUE] button while pressing the [SHIFT] button to select other Hot Cue to use in Keyboard mode.
- Pitches are assigned to the Performance Pads by default as follows.

+4 Semitone	+5 Semitone	+6 Semitone	+7 Semitone
0 Semitone	+1 Semitone	+2 Semitone	+3 Semitone

- Semitone is a unit of pitch. +1 semitone represents a semitone higher than the original key.
- Press the [PARAMETER 1 ◀] or [PARAMETER 1 ▶] button to shift the pitch range.

### 3 Press a Performance Pad.

The Hot Cue is played at the pitch assigned to the pad.

## Piano Play mode

In Piano Play mode, the Performance Pads on both decks light up like a piano's keyboard. You can use this mode to play Hot Cues in different pitches and musical scales.

### 1 Press the [ROLL] button while pressing the [SHIFT] button.

The unit switches to Piano Play mode.

### 2 Press a Performance Pad that has a Hot Cue assigned.

The Hot Cue assigned to the Performance Pad is selected.

### 3 Press a Performance Pad.

Playback starts from the selected Hot Cue point according to the pitch assigned to the Performance Pad.

- Press the [PARAMETER 1 ◀] or [PARAMETER 1 ▶] button on the left deck to shift the pitch range.
- Press the [PARAMETER 1 ◀] or [PARAMETER 1 ▶] button on the right deck to change the scale display for the Performance Pads. Pitches assigned to the Performance Pads don't change, even if the scale display is changed.
- Pitches and the scale display of each key range are assigned to the Performance Pads as follows.

#### — Up range: Minor pentatonic



#### — Up range: Major



— Up range: Major pentatonic

	+1	+3	
0	+2	+4	+5

+6	+8	+10	
+7	+9	+11	+12

— Middle range: Minor pentatonic

-6	-4	-2	
-5	-3	-1	0

+1	+3		+6
+2	+4	+5	+7

— Middle range: Major

-6	-4	-2	
-5	-3	-1	0

+1	+3		+6
+2	+4	+5	+7

— Middle range: Major pentatonic

-6	-4	-2	
-5	-3	-1	0

+1	+3		+6
+2	+4	+5	+7

— Down range: Minor pentatonic

	-11	-9	
-12	-10	-8	-7

-6	-4	-2	
-5	-3	-1	0

— Down range: Major

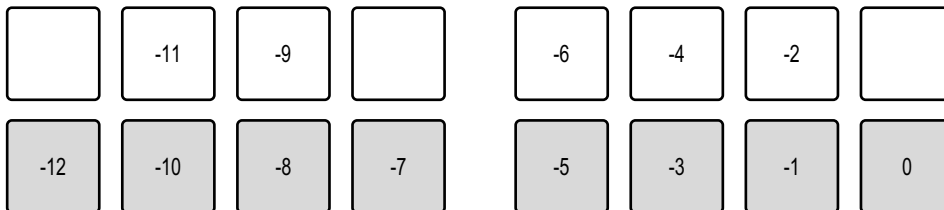

— Down range: Major pentatonic

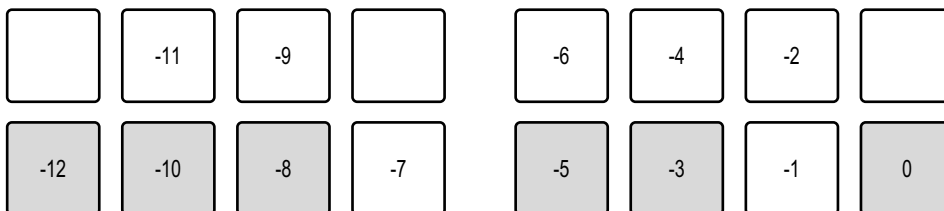

- You can check information such as the selected Hot Cue, octave range, and scales on the Piano Play screen of rekordbox.



- Hot Cue selected on each deck
- Selected octave range
- Selected scale

---

## Beat Loop mode

If you press a Performance Pad, loop playback starts according to the number of beats assigned to the Performance Pad and continues even if you release the pad.

### 1 Press the [SAVED LOOP] button while pressing the [SHIFT] button.

The unit switches to Beat Loop mode.

### 2 Press a Performance Pad.

Loop playback starts according to the number of beats assigned to the Performance Pad.

- The numbers of beats are assigned to the Performance Pads as follows.

1/4	1/2	1	2
4	8	16	32

- Press the Performance Pad again to cancel loop playback.

## Sample Scratch mode

You can load a track from a sampler slot in rekordbox to a deck.

### 1 Press the [SAMPLER] button while pressing the [SHIFT] button.

The unit switches to Sample Scratch mode.

### 2 Press the [PARAMETER 1 ◀] or [PARAMETER 1 ▶] button to switch Sampler Banks.

### 3 Press a Performance Pad.

The sound from the sampler slot assigned to the pad is loaded to the deck.

You can then scratch, etc. with the sound on the deck.

- Slots are assigned to Performance Pads as follows (slots 1 to 8 are for Deck 1 and Deck 3, and slots 9 to 16 are for Deck 2 and Deck 4).

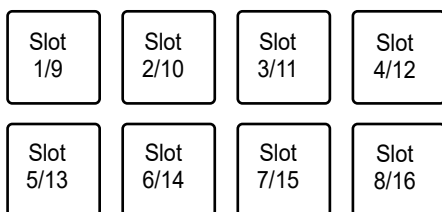

- If the play mode of the sampler slot is Oneshot, playback starts as it's loaded to the deck.
  - If the play mode of the sampler slot is Loop, the manual loop is set when it's loaded, and playback starts as it's loaded to the deck.
  - If Gate mode is set in the sampler slot, it operates as a cue point sampler while pressing the pad as it's loaded to the deck.
- Press the Performance Pad while pressing the [SHIFT] button again to unload the loaded track.

---

## User modes 1 to 4

You can assign your favorite rekordbox functions to the 8 Performance Pads on the unit using the MIDI Learn feature in rekordbox.

- For details on the MIDI Learn feature in rekordbox, refer to the rekordbox Instruction Manual (page 6).

---

## Deck Pads

---

### Deck Pads mode buttons

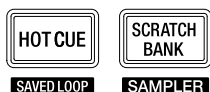

The unit switches to the following modes depending on how you operate the Deck Pads mode buttons.

Operation	[HOT CUE] button	[SCRATCH BANK] button
Press	Hot Cue mode	Sample Scratch mode
Press while pressing the [SHIFT] button	Beat Jump mode	Sampler mode

- You can use the pad buttons ([VOCAL/PAD 1], [MELODY/PAD 2], [BASS/PAD 3], [DRUMS/PAD 4]) to perform the same operations as Performance Pads 1 to 4 in each pad mode.



---



---

## Dual Deck mode

You can simultaneously control Decks 1 and 3 (or Decks 2 and 4) in Dual Deck Mode.



You can scratch or play a loop/Hot Cue, etc., as if the two different tracks are combined as one track.

### 1 Press the [DECK] button while pressing the [SHIFT] button.

The unit switches to Dual Deck mode.

- Deck 1 and Deck 2 become active. You can't change the active decks.
- Press the [DECK] button while pressing the [SHIFT] button to turn Dual Deck mode off.
- You can control the following functions in Dual Deck mode with the relevant buttons and knobs.

Buttons/knobs	Function
Jog wheel	Playback operations of the decks
[TRIM] knob	Volume adjustment
[HI, MID, LOW] knobs	EQ adjustment
Channel fader	Volume adjustment
Crossfader	Volume adjustment
[FILTER] knob	Effect adjustment
Effect lever	Effect control
Performance Pads	Performance Pads control
Loop operation buttons	Loop control
[SYNC] button	BPM matching
[KEY LOCK] button	Key Lock
Deck Pads buttons	Deck Pads control (modes other than Active Part mode)

Buttons/knobs	Function
[SLIP] button	Slip mode
[CENSOR  ] button	Slip reverse
[KEY -], [KEY +] buttons	Key adjustment
[CUE] button	Cue point control
 button	Play/pause
 [CUE] button	Headphones monitoring

## Auto BPM Transition

The unit can help with your mixing by automatically adjusting a track's BPM.

There are two types of Auto BPM Transition functions:

- Gradually matches with the BPM of a track on the other deck
- Gradually returns to the original BPM

### ❖ Matching with the BPM of a track on the other deck

- 1 Press one of the Pad buttons ([VOCAL/PAD 1], [MELODY/PAD 2], [BASS/PAD 3], [DRUMS/PAD 4]) while pressing the [SELECT] button to select a part to output during Auto BPM Transition.**
- 2 Press the [SELECT] button while pressing the [SHIFT] button to select the number of bars (how long the transition takes).**
- 3 Press the  (Auto BPM Transition Start) button.**

The BPM of the track on the deck you press the button on changes to match the BPM of the track on the other deck over the set number of bars. During the transition, only the sound of the selected part is output.

- Press the **▶** (Auto BPM Transition Start) button again during Auto BPM Transition to end Auto BPM Transition.

## ❖ Returning to the original BPM

- 1 Press one of the Pad buttons ([VOCAL/PAD 1], [MELODY/PAD 2], [BASS/PAD 3], [DRUMS/PAD 4]) while pressing the [SELECT] button to select a part to output during Auto BPM Transition.**
- 2 Press the [SELECT] button while pressing the [SHIFT] button to select the number of bars (how long the transition takes).**
- 3 Press the **▶** (Auto BPM Transition Start) button while pressing the [SELECT] button.**

The BPM of the track on the deck you press the button on returns to the original BPM over the set number of bars. During the transition, only the sound of the selected part is output.

---

## Slip

If you turn Slip mode on, normal playback continues in the background (but you can't hear it) during scratch play, loop playback, or Hot Cue playback.

When you end the operations, Slip is canceled and normal playback starts from the exact point the track would have reached by then. This means the original rhythm remains constant and your performance stays perfectly in time.

---

### Slip Scratch play

#### 1 Press the [KEY LOCK] button while pressing the [SHIFT] button.

Vinyl mode turns on.

- Check if the [KEY LOCK] button lights up while pressing the [SHIFT] button.

#### 2 Press the [SLIP] button.

Slip mode turns on and the [SLIP] button lights up.

#### 3 Turn the jog wheel to scratch during playback.

Normal playback continues with its original rhythm in the background.

- The [SLIP] button blinks while Slip is in use.
  - Release the jog wheel to start normal playback from the exact point the track would have reached by then.
- 
- Press the [SLIP] button again to turn Slip mode off.

---

## Slip Hot Cue

### 1 Press the [HOT CUE] button.

The unit switches to Hot Cue mode.

### 2 Press a Performance Pad at the point where you want to set a Hot Cue during playback or pause.

A Hot Cue is set.

### 3 Press the [SLIP] button.

Slip mode turns on and the [SLIP] button lights up.

### 4 Press and hold a Performance Pad during playback.

Playback starts from the Hot Cue point and continues while pressing the Performance Pad. Normal playback continues with its original rhythm in the background.

- The [SLIP] button blinks while Slip is in use.
  - Release the Performance Pad to start normal playback from the exact point the track would have reached by then.
- 
- Press the [SLIP] button again to turn Slip mode off.

---

## Slip Braking

- 1 Click **[Preferences]** → **[Controller]** → **[Deck]** on the rekordbox screen.
- 2 Adjust the speed at which playback slows down and stops in **[Touch/Brake]** under **[Vinyl Speed Adjust]**.

- To use Slip Braking, set it to slowly stop.

- 3 Press the **[SLIP]** button.

Slip mode turns on and the **[SLIP]** button lights up.

- 4 Press the **[▶/||]** button during playback.

Playback stops slowly.

Normal playback continues in the background while it's stopping slowly.

- The **[SLIP]** button blinks while Slip is in use.
  - Press the **[▶/||]** button again to start normal playback from the exact point the track would have reached by then.
- 
- Press the **[SLIP]** button again to turn Slip mode off.

---

## Slip Auto Beat Loop

- 1 Press the **[SLIP]** button.

Slip mode turns on and the **[SLIP]** button lights up.

- 2 Set a loop.

Loop playback starts.

Normal playback continues in the background during loop playback.

- The **[SLIP]** button blinks while Slip is in use.

- Press the [**AUTO LOOP**] button to cancel loop playback and start normal playback from the exact point the track would have reached by then.

➡ Read more: Setting a loop automatically (page 85), Setting a loop manually (page 85)

- Press the [**SLIP**] button again to turn Slip mode off.

---

---

## Fader Start

You can start playback by moving the fader knobs.

---

### Using Channel Fader Start

- 1 Select [CUE] in [Fader Start options.] on the [PREFERENCES] tab in Setting Utility.**

➡ Read more: Changing the settings (page 33)

- 2 Pause playback at the point you start playback.**

- 3 Press the [CUE] button on the deck you want to play a track.**

A cue is set.

- 4 Move the channel fader up from the bottom position while pressing the [SHIFT] button.**

Playback of the track starts from the cue point.

- Move the channel fader back to the bottom position while pressing the [**SHIFT**] button during playback to quickly return to the cue point and pause playback (Back Cue).
- If a cue isn't set in step 3, playback starts from the current position of the track.

---

## Using Crossfader Start

**1 Pause playback at the point you start playback.**

**2 Press the [CUE] button on the deck you want to play a track.**

A cue is set.

**3 Set the crossfader all the way to the left side or right side.**

- Set the crossfader to the opposite side of the channel which starts playback via Crossfader Start.

**4 Move the crossfader away from the left or right side while pressing the [SHIFT] button.**

Playback of the track starts from the cue point.

- Move the crossfader all the way back to the left or right side while pressing the [SHIFT] button during playback to quickly return to the cue point and pause playback (Back Cue).
- If a cue isn't set in step 2, playback starts from the current position of the track.



---

## Beat FX

You can add various effects according to the BPM of the track that's playing.

### 1 Press the [FX SELECT] button assigned with the effect you want to use.

- If you press multiple [FX SELECT] buttons with software effects assigned, you can use multiple software effects at the same time.
- Turn the rotary selector while pressing the [FX SELECT] button to select an effect type.

### 2 Press the [BEAT ◀] or [BEAT ▶] button to set the number of beats to synchronize the effect with.

- Press the [BEAT ▶] button while pressing the [SHIFT] button to automatically set BPM.
- Press the [BEAT ◀] button while pressing the [SHIFT] button to turn BPM tap mode on (BPM is set according to the average time between taps.).

### 3 Turn the [LEVEL/DEPTH] knob to adjust the effect.

- Turn the knob all the way counterclockwise to output the original sound.

### 4 Set the effect lever to [ON] or [LOCK ON].

The selected effect is applied to the sound of the channel on which you're using the effect lever.

---

## Recording

You can record the mixed sound of your performance using the recording function in rekordbox.

- For details on the recording function, see the rekordbox Instruction Manual (page 6).

### 1 Click on the rekordbox screen.

The [REC] panel appears.

### 2 Click on the [REC] panel.

Recording starts.

- Click  again to stop recording.
- If recording stops, the file is automatically saved.
- You can change the destination to save the file in [Preferences] → [Controller] → [Recording] on the rekordbox screen.

## Changing the settings in rekordbox

When rekordbox is connected to the unit, you can change the DJ play settings in [**Controller**] under [**Preferences**] on the rekordbox screen.

### ❖ Deck tab

\*: Factory setting

Setting item	Description
<b>AUTO BEAT LOOP</b>	<p>Sets the function applied when the [<b>AUTO LOOP</b>] button is pressed.</p> <ul style="list-style-type: none"> <li>Setting values: <b>Loop for specified beats, 1 Beat Loop, 2 Beat Loop, 4 Beat Loop, 8 Beat Loop, 16 Beat Loop, 32 Beat Loop</b></li> </ul>
<b>Slip Mode Flashing</b>	<p>Sets Slip Mode Flashing.</p> <ul style="list-style-type: none"> <li>Setting values: <b>Enable*</b>, <b>Disable</b></li> <li>If set to [<b>Enable</b>], the LEDs of buttons and knobs used for Slip operations blink ([<b>HOT CUE</b>] button, etc.) when Slip mode is turned on.</li> </ul>
<b>Slip button LED while slip mode is on</b>	<p>Sets whether to light up or blink the [<b>SLIP</b>] button when Slip mode is turned on.</p> <ul style="list-style-type: none"> <li>Setting values: <b>Light is on*</b>, <b>Blink</b></li> <li><b>[Light is on]</b>: Lights up the [<b>SLIP</b>] button when Slip mode is turned on, and blinks it during Slip playback.</li> <li><b>[Blink]</b>: Blinks the [<b>SLIP</b>] button when Slip is turned on.</li> </ul>

## ❖ Piano Play tab

\*: Factory setting

Setting item	Description
	Sets whether to display the Piano Play mode screen.
	<ul style="list-style-type: none"> <li>Setting values: <b>On</b>, <b>Only in Piano Play mode*</b>, <b>Off</b></li> </ul>
<b>Piano Play Panel Display</b>	<ul style="list-style-type: none"> <li><b>[On]</b>: Always displays the Piano Play mode screen when rekordbox is connected to the unit.</li> <li><b>[Only in Piano Play mode]</b>: Displays the Piano Play mode screen only when the unit is in Piano Play mode.</li> </ul>

## ❖ Mixer tab

Setting item	Description
	Determines whether or not to output the microphone sound to the <b>[BOOTH]</b> terminals.
<b>Booth output</b>	<ul style="list-style-type: none"> <li>If you remove the check mark of <b>[Do not output Mic sound to Booth]</b>, the microphone sound is output to the <b>[BOOTH]</b> terminals. If you mark the check mark, the microphone sound isn't output to the <b>[BOOTH]</b> terminals.</li> </ul>
<b>Mic input</b>	
	Sets the talkover level for the microphone.
<b>Talkover level</b>	<ul style="list-style-type: none"> <li>Setting values: <b>-6dB</b>, <b>-12dB</b>, <b>-18dB</b>, <b>-24dB</b></li> </ul>
	Sets the low-frequency cut function for the microphone sound.
<b>Low Cut Filter</b>	<ul style="list-style-type: none"> <li>Setting values: <b>OFF</b>, <b>ON</b></li> </ul>

Setting item	Description
<b>Headphones</b>	<p>Sets the output method (stereo or mono split) for the headphones monitor sound.</p> <ul style="list-style-type: none"> <li>Setting values: <b>STEREO, MONO SPLIT</b></li> <li><b>[MONO SPLIT]</b>: Outputs monitoring sound other than the master sound from the left channel and outputs the master sound from the right channel.</li> <li>If you mark the check box of <b>[Invert LR for headphones audio]</b> when <b>[MONO SPLIT]</b> is set, the left and right sounds of the headphones are swapped.</li> </ul>

## ❖ DDJ-REV5 tab

Setting item	Description
<b>Master Output</b>	
<b>Attenuator Level</b>	<p>Sets the attenuation level of the sound output from the <b>[MASTER 1]</b> and <b>[MASTER 2]</b> terminals.</p> <ul style="list-style-type: none"> <li>Setting values: <b>0dB, -6dB, -12dB</b></li> </ul>
<b>Monaural/Stereo Switching</b>	<p>Sets the output method (mono/stereo) for the sound output from the <b>[MASTER 1]</b> and <b>[MASTER 2]</b> terminals.</p> <ul style="list-style-type: none"> <li>Setting values: <b>Monaural, Stereo</b></li> </ul>
<b>Booth Output</b>	
<b>Attenuator Level</b>	<p>Sets the attenuation level of the sound output from the <b>[BOOTH]</b> terminals.</p> <ul style="list-style-type: none"> <li>Setting values: <b>0dB, -6dB, -12dB</b></li> </ul>
<b>Monaural/Stereo Switching</b>	<p>Sets the output method (mono/stereo) for the sound output from the <b>[BOOTH]</b> terminals.</p> <ul style="list-style-type: none"> <li>Setting values: <b>Monaural, Stereo</b></li> </ul>

Setting item	Description
<b>Peak Limiter</b>	
<b>Master Output</b>	<p>Reduces distortion to the sound output from the <b>[MASTER 1]</b> and <b>[MASTER 2]</b> terminals.</p> <ul style="list-style-type: none"> <li>Setting values: <b>ON, OFF</b></li> </ul>
<b>Mic Output (Master)</b>	<p>Reduces distortion to the microphone sound output from the <b>[MASTER 1]</b> and <b>[MASTER 2]</b> terminals.</p> <ul style="list-style-type: none"> <li>Setting values: <b>ON, OFF</b></li> </ul>
<b>Mic Out (Booth)</b>	<p>Reduces distortion to the microphone sound output from the <b>[BOOTH]</b> terminals.</p> <ul style="list-style-type: none"> <li>Setting values: <b>ON, OFF</b></li> </ul>
<b>Demo</b>	<p>Sets the amount of time until Demo mode starts when the unit is turned on but you're not using it.</p> <ul style="list-style-type: none"> <li>Setting values: <b>DEMO 1min, DEMO 5min, DEMO 10min*</b>, <b>DISABLE</b></li> <li>Demo mode is canceled if you operate knobs or buttons on the unit.</li> <li>The unit doesn't enter Demo mode when <b>[DISABLE]</b> is set.</li> </ul>
<b>AUTO STANDBY</b>	<p>Sets the auto standby function.</p> <ul style="list-style-type: none"> <li>Setting values: <b>ON, OFF</b></li> <li>When <b>[AUTO STANDBY]</b> is set to <b>[ON]</b>, the unit enters Standby mode after 4 hours without being used (no audio signal (more than -24 dB) is input to the unit).</li> <li>Press the <b>[SLIP]</b> button on the left deck to exit Standby mode.</li> </ul>

---

---

# Audio output

Follow the procedures below to output and adjust sound.

➡ To output sound to the [BOOTH] terminals, see Using a booth monitor (page 117).

---

---

## Outputting sound

---

### Adjusting the channel input volume

- 1 Slide the input selector switch to select an input sound source.**
- 2 Turn the [TRIM] knob to adjust the volume for the input sound.**

The channel level indicator lights up when sound is input to the channel.

---

### Adjusting the channel output volume

- 1 Move the channel fader to adjust the volume for the output sound.**
- 2 Move the crossfader to adjust the volume balance of the two channels.**

## Adjusting the master sound volume

- 1 Turn the **[MASTER LEVEL]** knob to adjust the volume for the master sound.

The master level indicator lights up when the master sound is output.

- When outputting sound from the speakers of a PC/Mac, adjust the volume of the speakers.

---

---

## Adjusting the sound

- 1 Turn the **[HI, MID, LOW]** knobs to adjust the volume of each band.

- The volume of a Stem/part is adjusted in Stems Level/part ISO mode.

---

---

## Setting the crossfader curve

- 1 Turn the **[CURVE]** knob to set the crossfader curve.

- Set the **[REVERSE]** switch to **[ON]** to reverse the operating direction of the crossfader.



---

---

# Monitoring sound

---

---

## Monitoring with headphones

**1 Connect headphones to one of the PHONES terminals.**

 Read more: Headphones section (page 26)

**2 Turn the [MIX] knob to adjust the volume balance between the channel sound and the master sound.**

**3 Press the [ CUE CH1] or [ CUE CH2] button to select the channel to monitor.**

**4 Turn the [LEVEL] knob to adjust the volume.**

---

---

## Using a booth monitor

**1 Connect a booth monitor to the [BOOTH] terminals.**

 Read more: Rear panel (page 27)

**2 Turn the [BOOTH LEVEL] knob to adjust the volume for the output sound.**

---

---

# Microphone

---

---

## Using a microphone

### 1 Connect a microphone to the [MIC 1] or [MIC 2] terminal.

- Microphone gain varies depending on the microphone you use. Before DJ, adjust the sound level according to your microphone with the [ATT.] knob on the rear of the unit.

➡ Read more: Connecting to the input terminals (page 36)

### 2 Slide the [OFF, ON, TALKOVER] selector switch to set the microphone sound output.

### 3 Turn the [LEVEL 1] or [LEVEL 2] knob in the MIC section to adjust the microphone volume level.

- Note that turning the knob too far clockwise outputs the sound at a high volume.

### 4 Turn the [EQ (HI, LOW)] knob to adjust the volume of each band.

### 5 Speak into the microphone.

---

---

# AUX

---

---

## Using AUX

**1 Connect an external device to the [AUX] terminals.**

➡ Read more: Rear panel (page 27), Connecting to the input terminals (page 36)

**2 Slide the [AUX (OFF, LINE, PORTABLE)] switch to select an external device to use.**

**3 Turn the [LEVEL] knob to adjust the volume of the input sound.**

---

---

# Settings

---

---

## Changing the settings

Change the settings in Utility mode.

- You can't use Utility mode when a PC/Mac running rekordbox is connected to the unit. In this case, change the settings in rekordbox instead (page 111).

### 1 Press and hold the **[BACK]** button.

Utility mode turns on.

### 2 Turn the rotary selector to select a setting item.

### 3 Press the rotary selector to confirm the selection.

The level indicator indicates the current setting item and setting value.

### 4 Turn the rotary selector to select a setting value.

### 5 Press the rotary selector to confirm the selection.

The setting is confirmed and the display returns to the top level in the hierarchy.

- Press the **[BACK]** button to cancel the setting.

### 6 Press the **[BACK]** button.

The settings screen closes.

- If you press the **[BACK]** button when changing the setting, the cursor returns to the selected setting item.
- If you press the **[BACK]** button while a setting item is selected, Utility mode closes.

## Utility settings

\*: Factory setting

: Blink

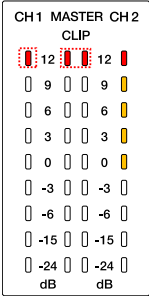
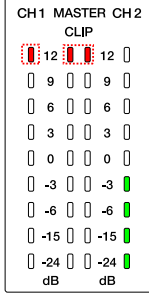
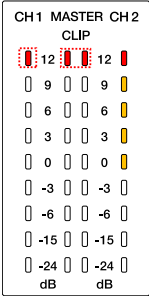
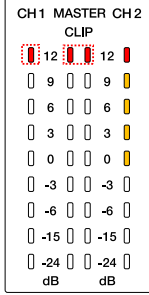
Setting item	Level indicator	Setting value	Level indicator	Description
<b>AUTO STANDBY</b>		<b>OFF</b>		<p>Sets the auto standby function.</p> <p>When it's set to <b>[ON]</b>, the unit enters standby mode after 4 hours without being used (no audio signal (more than -24 dB) is input to the unit).</p>
		<b>ON*</b>		

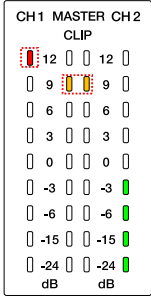
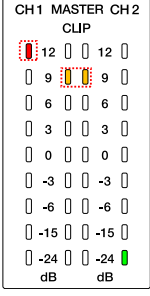
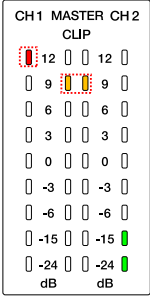
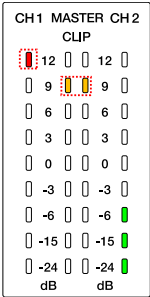
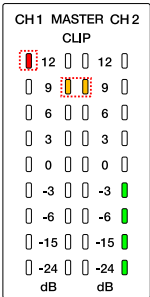
Setting item	Level indicator	Setting value	Level indicator	Description
<b>DEMO</b>	 <p>CH 1 MASTER CH 2 CLIP 12 12 9 9 6 6 3 3 0 0 -3 -3 -6 -6 -15 -15 -24 -24 dB dB</p>	<b>OFF</b>	 <p>CH 1 MASTER CH 2 CLIP 12 12 9 9 6 6 3 3 0 0 -3 -3 -6 -6 -15 -15 -24 -24 dB dB</p>	Sets the time until demo mode starts (the time you don't use the unit).
		<b>1min</b>	 <p>CH 1 MASTER CH 2 CLIP 12 12 9 9 6 6 3 3 0 0 -3 -3 -6 -6 -15 -15 -24 -24 dB dB</p>	
		<b>5min</b>	 <p>CH 1 MASTER CH 2 CLIP 12 12 9 9 6 6 3 3 0 0 -3 -3 -6 -6 -15 -15 -24 -24 dB dB</p>	
		<b>10min*</b>	 <p>CH 1 MASTER CH 2 CLIP 12 12 9 9 6 6 3 3 0 0 -3 -3 -6 -6 -15 -15 -24 -24 dB dB</p>	

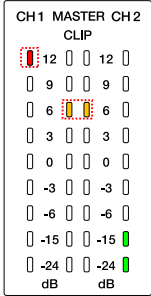
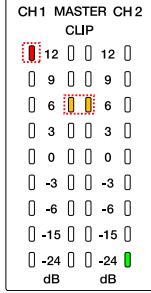
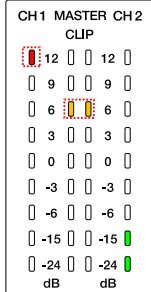
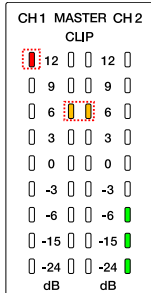
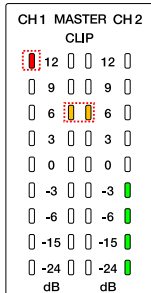
Setting item	Level indicator	Setting value	Level indicator	Description
<b>MIC TALKOVER LEVEL</b>		<b>-24dB</b>		Sets the talkover level for the microphone.
		<b>-18dB*</b>		
		<b>-12dB</b>		
		<b>-6dB</b>		

Setting item	Level indicator	Setting value	Level indicator	Description
<b>MIC LOW CUT</b>		<b>OFF</b>		Sets the low-frequency cut function for the microphone sound.
		<b>ON*</b>		
<b>PHONES OUT</b>		<b>MONO SPLIT</b>		Sets the output method (mono split or stereo) for the headphones monitor sound.
		<b>STEREO*</b>		



Setting item	Level indicator	Setting value	Level indicator	Description
<b>SPLIT CUE OUTPUT</b>		<b>NORMAL*</b>		Sets whether or not to invert the left and right sounds of headphones when <b>[PHONES OUT]</b> is set to <b>[MONO SPLIT]</b> .
		<b>INVERT</b>		
<b>MIC TO BOOTH</b>		<b>OFF</b>		Sets whether or not to mix the microphone sound with the sound output from the <b>[BOOTH]</b> terminals.
		<b>ON*</b>		

Setting item	Level indicator	Setting value	Level indicator	Description
<b>MIC LMT (MASTER)</b>		<b>OFF</b>		Sets whether or not to use the limiter for the microphone sound input to the sound output from the <b>[MASTER]</b> terminals.
		<b>ON*</b>		
<b>MIC LMT (BOOTH)</b>		<b>OFF</b>		Sets whether or not to use the limiter for the microphone sound input to the sound output from the <b>[BOOTH]</b> terminals.
		<b>ON*</b>		

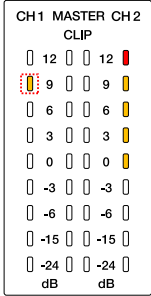
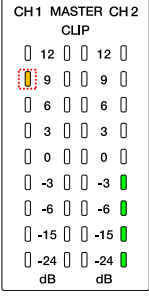
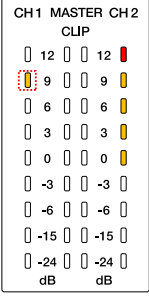
Setting item	Level indicator	Setting value	Level indicator	Description
<b>MASTER OUT</b>		<b>MONO</b>		Sets the output method (mono/ stereo) for the sound output from the <b>[MASTER]</b> terminals.
		<b>STEREO*</b>		

Setting item	Level indicator	Setting value	Level indicator	Description
<b>MASTER ATT.</b>		<b>-12dB</b>		Sets the attenuation level of the sound output from the <b>[MASTER]</b> terminals.
		<b>-6dB</b>		
		<b>0dB*</b>		

Setting item	Level indicator	Setting value	Level indicator	Description
<b>MASTER LIMITER</b>		<b>OFF</b>		Sets whether or not to reduce sudden and unpleasant digital clips that occur on the master output.
		<b>ON*</b>		
<b>BOOTH OUT</b>		<b>MONO</b>		Sets the output method (mono/ stereo) for the sound output from the <b>[BOOTH]</b> terminals.
		<b>STEREO*</b>		

Setting item	Level indicator	Setting value	Level indicator	Description
<b>BOOTH ATT.</b>		<b>-12dB</b>		Sets the attenuation level of the sound output from the [BOOTH] terminals.
		<b>-6dB</b>		
		<b>0dB*</b>		

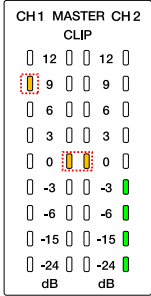
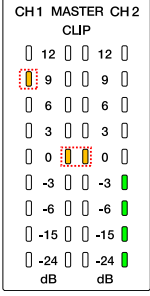
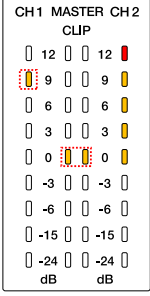
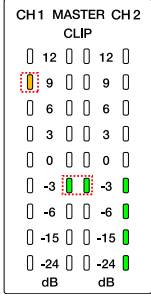
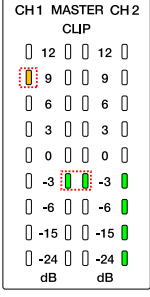
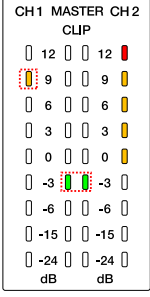
Setting item	Level indicator	Setting value	Level indicator	Description
<b>MIDI MODE</b>		<b>AUTO*</b>		Sets MIDI mode for the unit.
		<b>GENERAL</b>		
<b>FACTORY RESET</b>		<b>CANCEL*</b>		Restores the settings to the factory settings.
		<b>RESET</b>		

---

---

# Using other types of DJ software

If you connect the unit to a PC/Mac with MIDI software installed, via a USB cable, you can use the unit to control DJ software other than Serato DJ Pro and rekordbox.

- To play tracks stored on a PC (Windows) with the unit, install the dedicated audio driver software (page 29).
- For details on the unit's MIDI messages, visit the URL below.

[pioneerdj.com/support/](http://pioneerdj.com/support/)

- Install DJ software and configure the audio and MIDI settings on a PC/Mac beforehand.
- You can't use some buttons on the unit for controlling DJ software depending on the DJ software you use.



---

---

# Specifications

## AC adapter

Power requirements .....	AC 100 V – 240 V, 50 Hz/60 Hz
Rated current .....	1.2 A
Rated output .....	DC 5 V, 3.0 A/DC 9 V, 3.0 A/DC 12 V, 3.0 A/DC 15 V, 3.0 A/DC 20 V, 2.25 A

## General – Main Unit

Power consumption .....	DC 5 V, 3.0 A
Main unit weight .....	6.2 kg/13.7 lbs.
Max. external dimensions .....	(W x D x H) 736 x 377.2 x 73.4 mm/29.0" x 14.9" x 2.9"
Tolerable operating temperature .....	+5 °C – +35 °C (+41 °F – +95 °F)
Tolerable operating humidity .....	5 % – 85 % (no condensation)

## Audio Section

Sampling rate .....	48 kHz
A/D, D/A converter .....	24bit
Frequency characteristic	
USB, AUX (LINE/PORTABLE), MIC 1, MIC 2 .....	20 Hz – 20 kHz
S/N ratio (rated output, A-WEIGHTED)	
USB .....	110 dB
AUX (LINE) .....	95 dB
AUX (PORTABLE) .....	89 dB
MIC 1 .....	81 dB
MIC 2 .....	81 dB
Total harmonic distortion (20 Hz – 20 kHzBW)	
USB .....	0.003 %
Standard input level/Input impedance	
AUX (LINE) .....	-12 dBu/47 kΩ
AUX (PORTABLE) .....	-24 dBu/47 kΩ
MIC 1 .....	-57 dBu/3 kΩ
MIC 2 .....	-57 dBu/3 kΩ
Standard output level/Load impedance/Output impedance	
MASTER 1 .....	+6 dBu/10 kΩ/450 Ω or less
MASTER 2 .....	+2 dBu/10 kΩ/820 Ω or less
BOOTH .....	+6 dBu/10 kΩ/900 Ω or less
PHONES .....	+8 dBu/32 Ω/10 Ω or less

## Rated output level/Load impedance

MASTER 1 .....	+24 dBu/10 kΩ
MASTER 2 .....	+20 dBu/10 kΩ
BOOTH .....	+24 dBu/10 kΩ

## Microphone equalizer characteristic

HI.....	-12 dB – +12 dB (10 kHz)
LOW.....	-12 dB – +12 dB (100 Hz)

## Input/Output terminals

### MIC input terminal

XLR connector & 1/4" TRS jack .....	1 set
1/4" TRS jack .....	1 set

### AUX input terminal

RCA pin jacks.....	1 set
--------------------	-------

### MASTER 1 output terminal

XLR connector .....	1 set
---------------------	-------

### MASTER 2 output terminal

RCA pin jacks.....	1 set
--------------------	-------

### BOOTH output terminal

1/4" TRS jack .....	1 set
---------------------	-------

### PHONES output terminal

1/4" stereo phone jack .....	1 set
3.5 mm stereo mini jack .....	1 set

### USB terminals

USB Type-C .....	2 sets
------------------	--------

## Specifications of external power supply (for European Union customers)

Manufacturer's name .....	AlphaTheta EMEA Limited
Commercial registration number.....	09230173
Address.....	Unit 39, Tileyard Studios, Tileyard Road, London, N7 9AH, U.K.
Model identifier.....	FSP045-A2CR3
Input voltage .....	AC 100 V to 240 V
Input AC frequency .....	50 Hz/60 Hz
Output voltage.....	DC 5.0 V/9.0 V/12.0 V/15.0 V/20.0 V
Output current.....	3.0 A/3.0 A/3.0 A/3.0 A/2.25 A
Output power .....	15.0 W/27.0 W/36.0 W/45.0 W/45.0 W
Average active efficiency .....	81.5 %
Efficiency at low load (10 %).....	76.3 %
No-load power consumption .....	0.06 W

## Information requirements of the European Ecodesign Directive

English

- Use the [**MASTER 1**] terminals for balanced output only. Connecting the terminals to unbalanced inputs (RCA, etc.) with an XLR-RCA conversion cable (conversion adapter), etc. results in unwanted noises and/or poor sound quality.
- Use the [**MASTER 2**] terminals for unbalanced input (RCA, etc.).
- Use the [**BOOTH**] terminals for balanced output only. Connecting the terminals to unbalanced inputs (RCA, TS connector, etc.) with a TRS-RCA conversion cable (conversion adapter) or TS cable, etc. results in unwanted noises and/or poor sound quality.

The specifications and design of this product are subject to change without notice.

---

---

# Additional information

---

---

## Troubleshooting

If you think something is wrong with the unit, check the information below and refer to the [FAQ] for the DDJ-REV5 at the URL below.

[pioneerdj.com/support/](http://pioneerdj.com/support/)

- Inspect devices connected with the unit.
- The unit may restore proper operation after you turn it off and on (the unit may not work properly due to external influences such as static electricity. In such cases, you can restore normal operation by turning the unit off and on).

If the problems continue, read the Precautions for Use and consult an authorized service company or your dealer.

---

---

## Power

### ❖ The unit doesn't turn on.

- See Connections (page 36).
- Press the ⏻ button on the rear of the unit to turn it on.

---

---

## Connection

### ❖ The unit isn't recognized.

- Connect the supplied USB cable properly (page 36).
- When using a USB hub, use a product recommended by the manufacturer of your PC/Mac.
- If a USB device other than this unit is connected to your PC/Mac, disconnect it.
- If you use a PC (Windows), install the dedicated audio driver software properly (page 29).
- Close all applications (including any screen saver and resident software) running on your PC/Mac before using the unit. When you close anti-virus software, etc., disconnect from the internet to ensure the safety of your PC/Mac.
- If you use a PC (Windows), uninstall unnecessary ASIO drivers other than the one for this unit.

- Check if the unit is recognized by your PC/Mac, and the firmware version of the unit is displayed in Setting Utility (page 35).

---

### Audio output

#### ❖ The unit doesn't output sound / The volume is low / The sound is distorted.

- Set the [TRIM] knob, [MASTER LEVEL] knob, and input selector switch properly.
- Check all cables are connected properly (page 27).
- Wipe any dust or dirt off the terminals and plugs before connecting them.
- If you use a Mac, set the buffer size (latency) properly for the DJ software you're using.
- If you use a PC (Windows), set the buffer size properly in Setting Utility (page 32).

#### ❖ Microphone sound isn't output.

- Set the [OFF, ON, TALKOVER] selector switch properly.
- Set the [ATT.] and [MIC LEVEL] knobs properly.

#### ❖ Sampler sound can't be monitored with headphones.

- Set the [SAMPLER VOLUME] knob properly.

---

### Serato DJ Pro

#### ❖ Serato DJ Pro is unstable.

- Update Serato DJ Pro to the latest version.
- Close all software other than Serato DJ Pro. If Serato DJ Pro is still unstable, disable the wireless connection, anti-virus software, screen-saver, and power saving mode. When you close anti-virus software, etc., disconnect from the internet to ensure the safety of your PC/Mac.
- If a USB device other than this unit is connected to your PC/Mac, disconnect it.
- If you're using your laptop with battery power, connect it to the AC power.

#### ❖ Tracks aren't displayed in the library.

- If tracks aren't displayed in the library, import audio files. For details on how to import audio files, refer to the Serato DJ Pro software manual (page 6).

- Check if you've selected a crate or subcrate that doesn't include tracks. If so, select a crate or subcrate that includes tracks, or add tracks to the crate or subcrate.

### ❖ **Tracks from iTunes aren't displayed in the library.**

- If no check mark is placed in the check box for [**Show iTunes Library**] on the [**Library + Display**] tab of the [**SETUP**] menu, mark the check box. If a check mark has been placed in the check box, remove it and mark the check box again. For details on how to import audio files, refer to the Serato DJ Pro software manual (page 6).
- Check if you've selected a crate or subcrate that doesn't include tracks. If so, select a crate or subcrate that includes tracks, or add tracks to the crate or subcrate.

### ❖ **Audio files in the library can't be edited.**

- If [**Protect Library**] is enabled on the [**Library + Display**] tab of the [**SETUP**] menu, disable it.

### ❖ **The virtual deck of Serato DJ Pro isn't displayed (offline player is displayed).**

- Connect the supplied USB cable correctly (page 36).
- Update Serato DJ Pro to the latest version.

### ❖ **Fader Start doesn't work.**

- Set a cue.
- Enable the Fader Start function in the Setting Utility (page 33).

### ❖ **BPM isn't displayed / Sync/Auto Loop doesn't work.**

- Mark the check boxes for [**Analysis Settings**] and [**Set Beat Grid/BPM**] in the offline player setting, then analyze tracks. For details on how to analyze tracks, refer to the Serato DJ Pro software manual (page 6).

### ❖ **BPM and beatgrid aren't displayed correctly / Beatgrid isn't accurate.**

- Change the BPM analysis range, then analyze the track again. If it doesn't resolve the problem, manually set the beatgrid and/or BPM.
- Adjust the beatgrid. For details on how to adjust the beatgrid, refer to the Serato DJ Pro software manual (page 6).

### ❖ **Playback sound is interrupted when using Serato DJ Pro.**

- If you use a Mac, set the buffer size (latency) properly for Serato DJ Pro.
- If you use a PC (Windows), set the buffer size properly in Setting Utility (page 32).

### ❖ **BPM is displayed but the beatgrid isn't displayed / Slicer Loop doesn't work / Jog Skip doesn't work.**

- Mark the check boxes for [Analysis Settings] and [Set Beat Grid/BPM] in the offline player setting, then analyze the track. For details on how to analyze tracks, refer to the Serato DJ Pro software manual (page 6).
- Set the beatgrid. For details on how to set the beatgrid, refer to the Serato DJ Pro software manual (page 6).

---

## rekordbox

### ❖ **rekordbox is unstable.**

- Update rekordbox to the latest version (page 77).
- Close all software other than rekordbox. If rekordbox is still unstable, disable your anti-virus software, screen-saver, and power-saving mode. When you close your anti-virus software, etc., disconnect from the internet to ensure the safety of your PC/Mac.
- If a USB device other than this unit is connected to your PC/Mac, disconnect it.
- When using a USB hub, use a product recommended by the manufacturer of your PC/Mac.
- If you're using your laptop with battery power, connect it to the AC power.

### ❖ **Can't control rekordbox from the unit / The platter isn't displayed on the deck / Can't find the setting items mentioned in the manual.**

- If [EXPORT] mode is turned on, click [EXPORT] in the upper left of the rekordbox screen then click [PERFORMANCE] to switch to Performance mode.

### ❖ **BPM and beatgrid aren't displayed correctly / Beatgrid isn't accurate.**

- Change the BPM analysis range, then analyze the track again. If it doesn't resolve the problem, manually set the beatgrid and/or BPM.
- Adjust the beatgrid. For details on how to adjust the beatgrid, refer to the rekordbox Instruction Manual (page 6).

### ❖ **Playback sound is interrupted when using rekordbox.**

- Set the buffer size (latency) properly in [Audio] under [Preferences] on the rekordbox screen.

### ❖ **Fader Start doesn't work.**

- Set a cue.

### ❖ **Recording isn't possible when a PC/Mac running rekordbox isn't connected to the unit.**

- If you haven't signed up for a rekordbox subscription plan, you can't use the recording function when a PC/Mac running rekordbox isn't connected to the unit. Connect this unit or another Hardware Unlock device, or sign up for a subscription plan to enable recording.

---

## Others

### ❖ **Indicators blink and something is wrong with the unit.**

- If something is wrong with the unit or the unit doesn't turn on, pull out the AC adapter cable from the DC jack, then connect it after a while. If this doesn't resolve the problem, request a repair.



### **Trademarks and registered trademarks**

- Pioneer DJ is a trademark of PIONEER CORPORATION and is used under license.
- Serato DJ Pro is a registered trademark of Serato Limited.
- rekordbox™ is a trademark or registered trademark of AlphaTheta Corporation.
- Mac, macOS and Finder are trademarks of Apple Inc., registered in the U.S. and other countries and regions.
- Windows is a registered trademark of Microsoft Corporation in the U.S. and other countries.
- ASIO is a trademark or registered trademark of Steinberg Media Technologies GmbH.

Other product, technology and company names, etc. mentioned herein are trademarks or registered trademarks of their respective owners.

---

## Software license notice

### Apache

Copyright (c) 2009-2019 ARM Limited. All rights reserved.

SPDX-License-Identifier: Apache-2.0

Licensed under the Apache License, Version 2.0 (the License); you may not use this file except in compliance with the License.

You may obtain a copy of the License at

[www.apache.org/licenses/LICENSE-2.0](http://www.apache.org/licenses/LICENSE-2.0)

Unless required by applicable law or agreed to in writing, software distributed under the License is distributed on an AS IS BASIS, WITHOUT WARRANTIES OR CONDITIONS OF ANY KIND, either express or implied.

See the License for the specific language governing permissions and limitations under the License.

### BSD

The Clear BSD License

Copyright (c) 2016, Freescale Semiconductor, Inc.

Copyright 2016-2017 NXP

All rights reserved.

Redistribution and use in source and binary forms, with or without modification, are permitted (subject to the limitations in the disclaimer below) provided that the following conditions are met:

- Redistributions of source code must retain the above copyright notice, this list of conditions and the following disclaimer.
- Redistributions in binary form must reproduce the above copyright notice, this list of conditions and the following disclaimer in the documentation and/or other materials provided with the distribution.

- Neither the name of the copyright holder nor the names of its contributors may be used to endorse or promote products derived from this software without specific prior written permission.

NO EXPRESS OR IMPLIED LICENSES TO ANY PARTY'S PATENT RIGHTS ARE GRANTED BY THIS LICENSE. THIS SOFTWARE IS PROVIDED BY THE COPYRIGHT HOLDERS AND CONTRIBUTORS "AS IS" AND ANY EXPRESS OR IMPLIED WARRANTIES, INCLUDING, BUT NOT LIMITED TO, THE IMPLIED WARRANTIES OF MERCHANTABILITY AND FITNESS FOR A PARTICULAR PURPOSE ARE DISCLAIMED. IN NO EVENT SHALL THE COPYRIGHT HOLDER OR CONTRIBUTORS BE LIABLE FOR ANY DIRECT, INDIRECT, INCIDENTAL, SPECIAL, EXEMPLARY, OR CONSEQUENTIAL DAMAGES (INCLUDING, BUT NOT LIMITED TO, PROCUREMENT OF SUBSTITUTE GOODS OR SERVICES; LOSS OF USE, DATA, OR PROFITS; OR BUSINESS INTERRUPTION) HOWEVER CAUSED AND ON ANY THEORY OF LIABILITY, WHETHER IN CONTRACT, STRICT LIABILITY, OR TORT (INCLUDING NEGLIGENCE OR OTHERWISE) ARISING IN ANY WAY OUT OF THE USE OF THIS SOFTWARE, EVEN IF ADVISED OF THE POSSIBILITY OF SUCH DAMAGE.

---

## Cautions on copyrights

Recordings you have made are for your personal enjoyment and according to copyright laws may not be used without the consent of the copyright holder.

- Music recorded from CDs, etc., is protected by the copyright laws of individual countries and by international treaties. It is the full responsibility of the person who has recorded the music to ensure that it is used legally.
- When handling music downloaded from the Internet, etc., it is the full responsibility of the person who has downloaded the music to ensure that it is used in accordance with the contract concluded with the download site.

The specifications and design of this product are subject to change without notice.

© 2023 AlphaTheta Corporation. All rights reserved.

<DRI1872-A>